

GV2MP

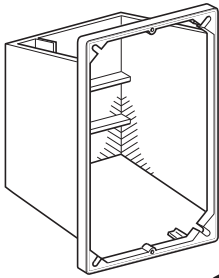

GV2MP

3

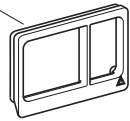
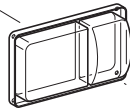
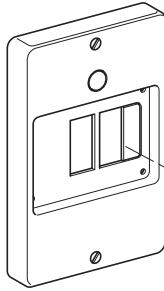

GV2E01

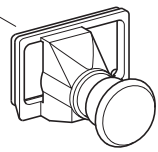
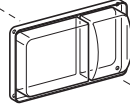

GV2K011

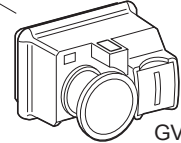

GV2K021
GV2K031



GV2K04

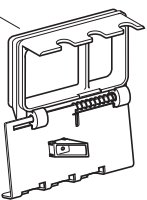
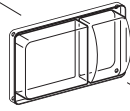

GV2V01

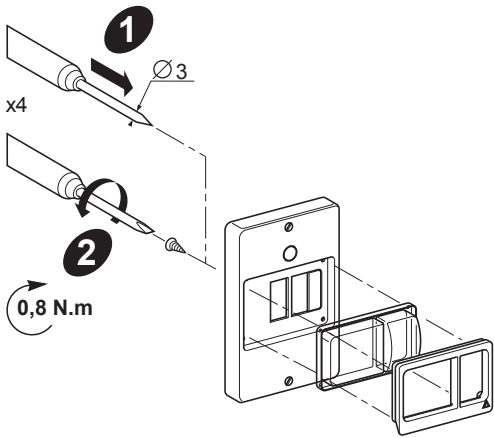
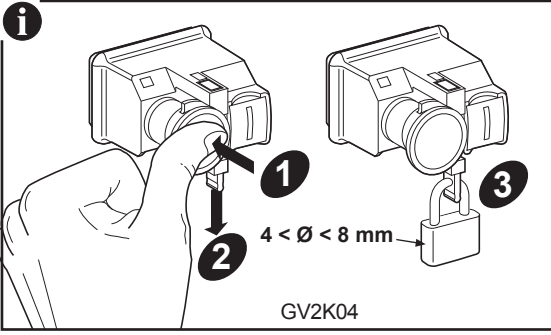

<p>PLEASE NOTE Electrical equipment should be installed, operated, serviced, and maintained only by qualified personnel. No responsibility is assumed by Schneider Electric for any consequences arising out of the use of this material.</p>	<p>REMARQUE IMPORTANTE L'installation, l'utilisation, la réparation et la maintenance des équipements électriques doivent être assurées par du personnel qualifié uniquement. Schneider Electric décline toute responsabilité quant aux conséquences de l'utilisation de cet appareil.</p>
--	---

<p>TENGA EN CUENTA La instalación, manejo, puesta en servicio y mantenimiento de equipos eléctricos deberán ser realizados sólo por personal cualificado. Schneider Electric no se hace responsable de ninguna de las consecuencias del uso de este material.</p>	<p>BITTE BEACHTEN Elektrische Geräte dürfen nur von Fachpersonal installiert, betrieben, bedient und gewartet werden. Schneider Electric haftet nicht für Schäden, die durch die Verwendung dieses Materials entstehen.</p>
--	--

<p>NOTA Manutenzione, riparazione, installazione e uso delle apparecchiature elettriche si devono affidare solo a personale qualificato. Schneider Electric non si assume alcuna responsabilità per qualsiasi conseguenza derivante dall'uso di questi prodotti.</p>	<p>NOTA A instalação, utilização e manutenção do equipamento eléctrico devem ser efectuadas exclusivamente por pessoal qualificado. A Schneider Electric não assume qualquer responsabilidade pelas consequências resultantes da utilização deste material.</p>
---	--

<p>请注意 电气设备的安装、操作、维修和维护工作仅限于合格人员执行。 Schneider Electric不承担由于使用本资料所引起的任何后果。</p>	<p>ОБРАТИТЕ ВНИМАНИЕ Электрическое оборудование должно обслуживаться квалифицированным персоналом. Компания Schneider Electric не несет ответственности за последствия, связанные с использованием данной документации. Данная документация не предназначена для использования в качестве руководства людьми, не прошедшими какого-либо обучения.</p>
---	--

<p>Schneider Electric Industries SAS 35, rue Joseph Monier CS 30323 F - 92506 Rueil Malmaison Cedex</p> <p>© 2015 Schneider Electric - All rights reserved.</p>	<p>Уполномоченный поставщик в РФ: АО «Шнейдер Электрик» Адрес: 127018, г. Москва, ул. Двинцев, д. 12, корп. 1, тел. +7 (495)777 99 88, факс: +7 (495)777 99 94, 8-800-200-6446 www.schneider-electric.ru</p>  
--	--

⚠ ⚠ DANGER / DANGER / PELIGRO / GEFAHR / PERICOLO / PERIGO / 危险 / ОПАСНО

<p>HAZARD OF ELECTRIC SHOCK, EXPLOSION, OR ARC FLASH Disconnect all power before servicing equipment.</p> <p>Failure to follow these instructions will result in death or serious injury.</p>	<p>RISQUE D'ÉLECTROCUTION, D'EXPLOSION OU D'ECLAIR D'ARC ELECTRIQUE Coupez toutes les alimentations avant de travailler sur cet appareil.</p> <p>Le non-respect de ces instructions provoquera la mort ou des blessures graves.</p>
---	---

<p>PELIGRO DE DESCARGA ELÉCTRICA, EXPLOSIÓN O ARCO ELÉCTRICO Desconecte todas las alimentaciones antes de manipular el producto. Si no se siguen estas instrucciones provocará lesiones graves o incluso la muerte.</p>	<p>GEFAHR VON ELEKTRISCHEM SCHLAG, EXPLOSION ODER LICHTBOGEN Vor dem Arbeiten am Gerät alle Spannungsversorgungen abschalten. Die Nichtbeachtung dieser Anweisungen führt zu Tod oder schwereren Verletzungen.</p>
---	--

<p>RISCHIO DI SCARICA ELETTRICA , ESPLOSIONE O ARCO ELETTRICO Scollegare l'apparecchio da tutti i circuiti di alimentazione prima di qualsiasi intervento. Il mancato rispetto di queste istruzioni provocherà morte o gravi infortuni.</p>	<p>RISCO DE ELECTROCUSSÃO, DE EXPLOSIÃO, OU DE ARCO ELÉCTRICO Desconecte todas as alimentações antes de manipular o produto. A não observância destas instruções resultará em morte, ou ferimentos graves.</p>
---	--

<p>电击、爆炸或电弧闪光危险 在此电力设备上工作时, 请先切断所有电源。 若违背这些说明, 不遵循上述说明将导致人员伤亡。</p>	<p>Опасность поражения электрическим током, опасность взрыва или вспышки дуги. Перед обслуживанием или ремонтом убедитесь, что питание отключено. Несоблюдение этих инструкций приведет к смерти или серьезной травме.</p>
--	--

<p>The product's manufacture date is coded as PP-YY-WW, where:</p> <ul style="list-style-type: none"> ● PP: plant code ● YY: year of manufacture ● WW: week of manufacture <p>Eg: DT1429 = product manufactured at plant DT on week 29 2014.</p>	<p>La date de fabrication du produit est codée sous la forme PP-YY-WW, où :</p> <ul style="list-style-type: none"> ● PP: code de l'usine ● YY: année de fabrication ● WW: semaine de fabrication <p>Ex: DT1429 = produit a été fabriqué à l'usine DT la semaine 29 de 2014.</p>
<p>La fecha fabricación del producto está codificada como PP-YY-WW, donde:</p> <ul style="list-style-type: none"> ● PP: código de planta ● YY: año de fabricación ● WW: semana de fabricación <p>Ej: DT1429 = producto ha sido fabricado en la planta DT, la semana 29 del año 2014.</p>	<p>Das Herstellungsdatum des Produkts weist folgendes Format auf: PP-YY-WW. Hierbei gilt Folgendes:</p> <ul style="list-style-type: none"> ● PP: Code der Produktionsstätte ● YY: Herstellungsjahr ● WW: Herstellungswoche <p>Z. B.: DT1429 = Produkt, das in der Produktionsanlage DT in der Woche 29 des Jahres 2014 hergestellt wurde.</p>
<p>La data di costruzione del prodotto è codificata come segue PP-YY-WW, dove:</p> <ul style="list-style-type: none"> ● PP: codice stabilimento ● YY: anno di costruzione ● WW: settimana di fabbricazione <p>Ad es: Il codice DT1429 = prodotto è stato fabbricato presso lo stabilimento DT nella settimana 29 del 2014.</p>	<p>A data de fabrico do produto está codificada como PP-YY-WW, sendo que:</p> <ul style="list-style-type: none"> ● PP: código de fábrica ● YY: ano do fabrico ● WW: semana de fabrico <p>Ex: DT1429 = produto foi criado na fábrica DT na semana 29 de 2014.</p>
<p>产品制造日期编码为 PP-YY-WW，其中：</p> <ul style="list-style-type: none"> ● PP：工厂代码 ● YY：制造年份 ● WW：第几周制造 <p>例如：DT1429 = 该产品于 2014 年第 29 周在工厂 DT 制造。</p>	<p>Дата производства продукта указана в виде кода PP-YY-WW, где:</p> <ul style="list-style-type: none"> ● PP: код завода; ● YY: год производства; ● WW: неделя производства <p>Пример. DT1429 = продукт произведен на заводе DT на 29-й неделе 2014 года.</p>

GV2MC

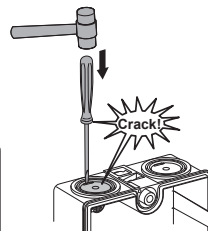
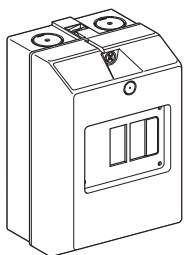

2

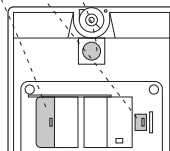
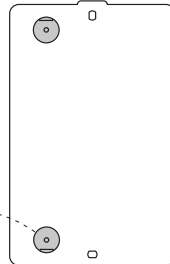
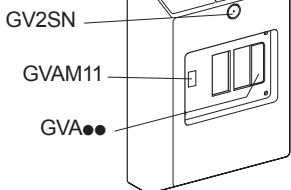

GV2MP

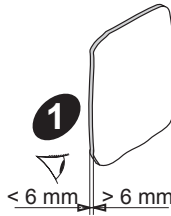
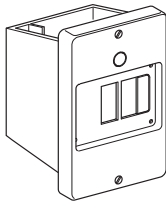

< 6 mm ⇒ Page 7/8
> 6 mm ⇒ Page 8/8

2

Page 7

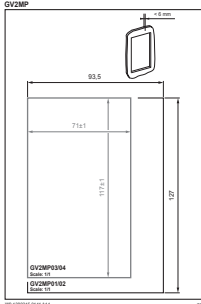

2

Page 8

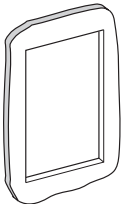
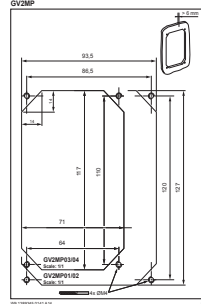

3

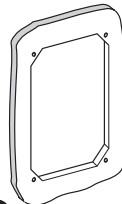
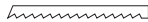

3

4x ØM4

4

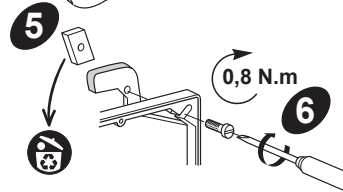
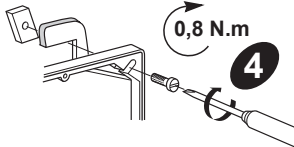

GV2MC

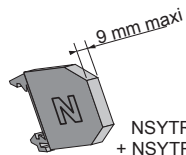
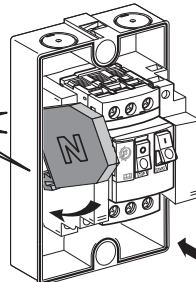
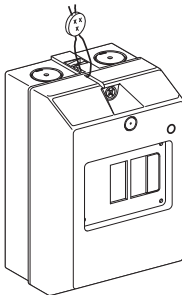

NSYTRV62BL
+ NSYTRAC22BL

GV2SN

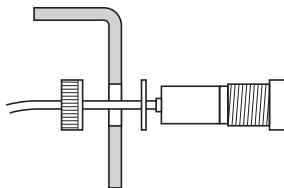
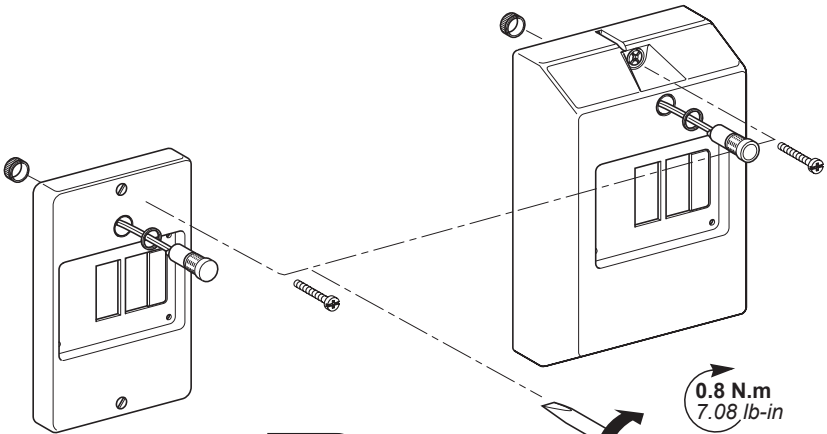
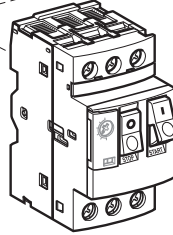
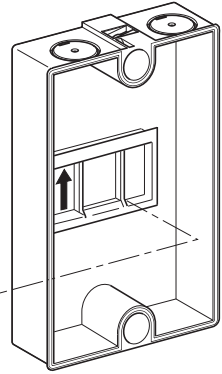
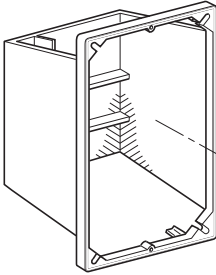
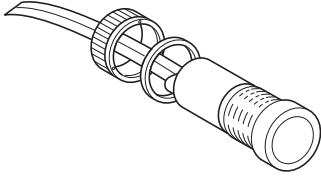

GV2MP

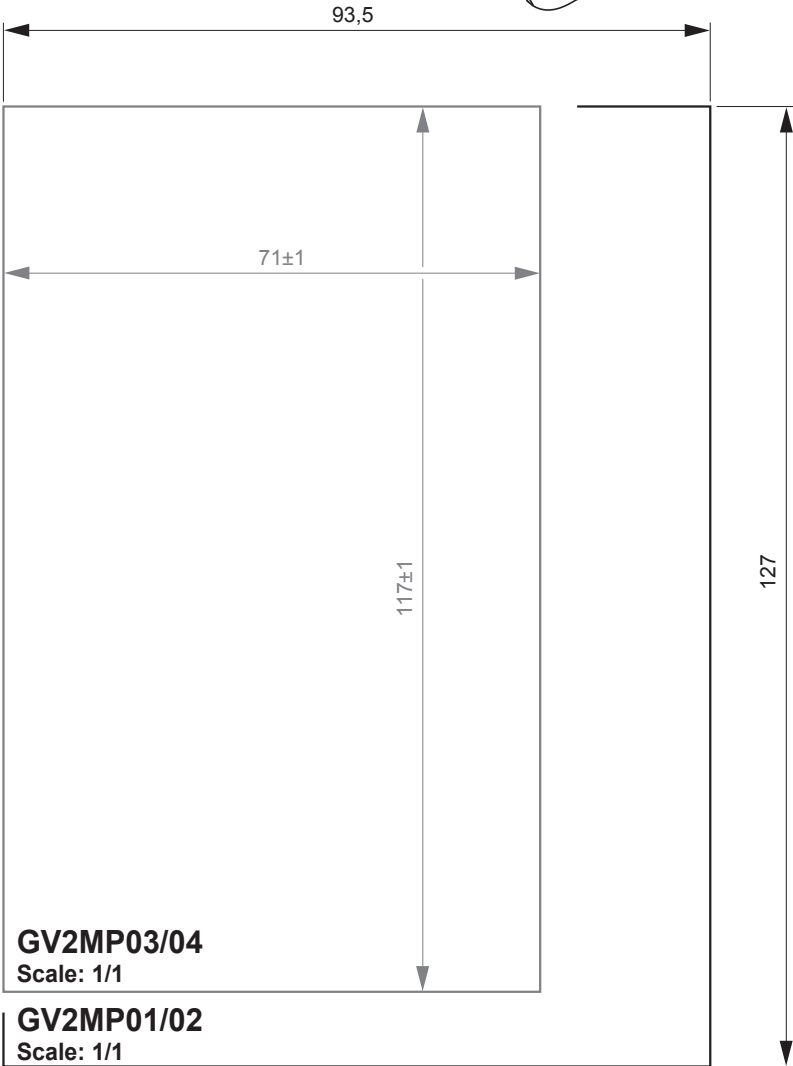
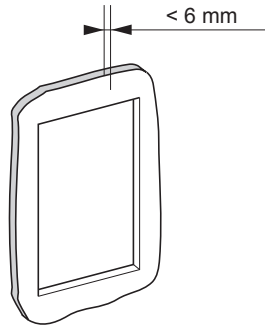

GV2MP03/04
Scale: 1/1

GV2MP01/02
Scale: 1/1

GV2MP

> 6 mm

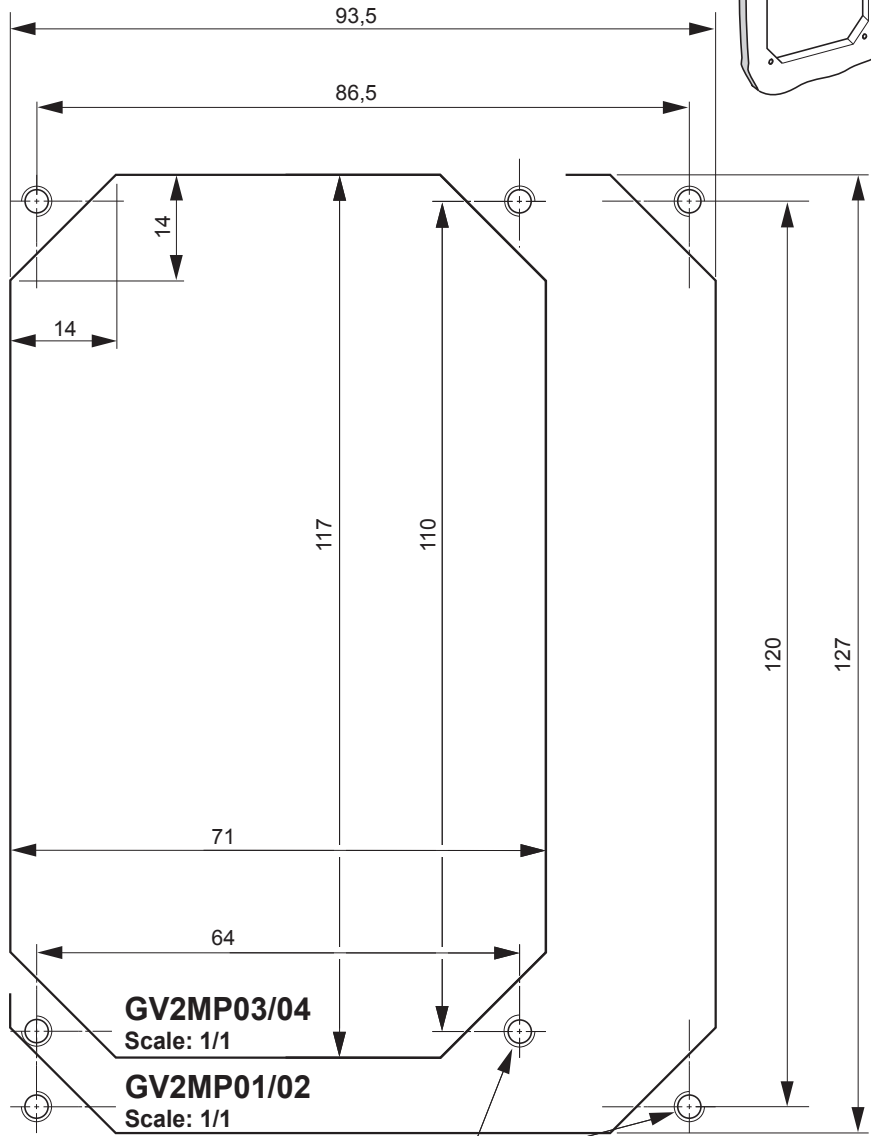
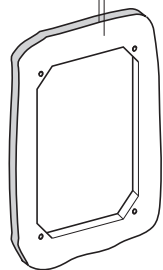

GV2MP03/04
Scale: 1/1

GV2MP01/02
Scale: 1/1

 4x ØM4