

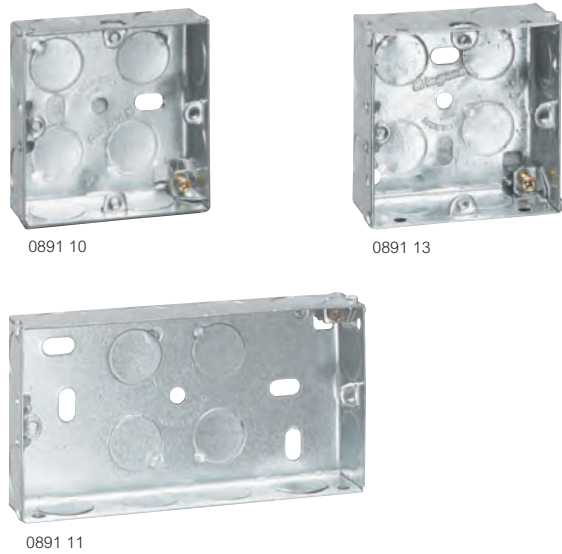

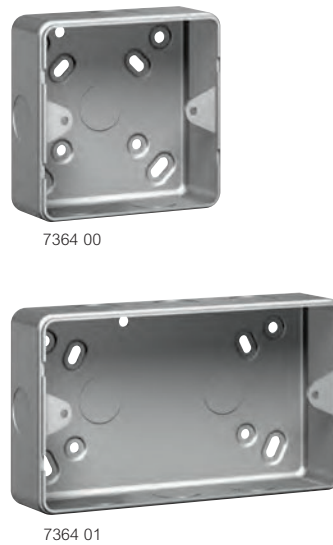





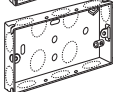

flush mounting steel back boxes

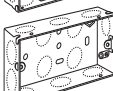
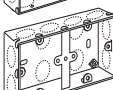

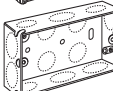

surface mounting metal back boxes

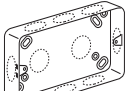

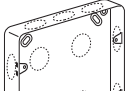
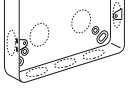
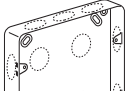
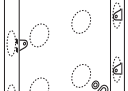
Pack	Cat. Nos.	Flush mounting back boxes
		Conform to BS 4662 Material : galvanised steel Top, side and back knockout entries according to type of box
		Depth 16 mm
100	0891 09	 1 gang with 1 fixed lug, 1 adjustable lug and 1 earth terminal
		Depth 25 mm
50	0891 10	 1 gang with 3 fixed lugs, 1 adjustable lug and 1 earth terminal
10	0891 11	 2 gang with 1 fixed lug, 1 adjustable lug and 1 earth terminal
		Depth 35 mm
50	0891 13	 1 gang with 3 fixed lugs, 1 adjustable lug and 1 earth terminal
40	0891 14	 2 gang with 1 fixed lug, 1 adjustable lug and 1 earth terminal
40	0891 40	 Dual box with 2 earth terminals Accepts 2 single gang accessories
		Depth 48 mm
25	0891 17	 1 gang with 3 fixed lugs, 1 adjustable lug and 1 earth terminal
20	0891 18	 2 gang with 1 fixed lug, 1 adjustable lug and 1 earth terminal

Pack	Cat. Nos.	Surface mounting metal back boxes
		Conform to BS 5733 where applicable Material : grey epoxy coated steel
		Depth 37 mm
		Dimensions : 86 x 86 mm
10	7364 00	 1 gang With knockouts
10	7364 20	 1 gang Without knockouts
		Dimensions : 86 x 146 mm
5	7364 01	 2 gang With knockouts
5	7364 21	 2 gang Without knockouts
		Dimensions : 146 x 146 mm
1	7364 18	 6/8 module grid With knockouts
1	7364 22	 6/8 module grid Without knockouts
		Dimensions : 207 x 146 mm
1	7364 28	 9/12 module grid With knockouts
1	7364 32	 9/12 module grid Without knockouts

Pack	Cat. Nos.	Architrave back boxes
		Depth 26 mm
5	7364 40	 Dimensions : 82 x 28 mm
5	7364 41	 Dimensions : 142 x 28 mm