

Термоконтролер с LCD дисплей

NEW

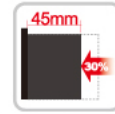

Характеристики:

Голям LCD дисплей с бели знаци лесни за разчитане.

LDC дисплея е с големина 15,3мм и предлага видимост при различна среда.

Светла среда

Тъмна среда



Дисплея лесно може да се гледа от различни ъгли.



Компактен дизайн с дължина 45мм

Намалената дължина спомага за улесняване на монтажа. Дължината е намалена 30% спрямо стандартните размери на други термоконтролери



- 11те сегмента на дисплея позволяват за по добра четимост.

Дисплей с 7 сегмента



Дисплей на TX4S



- 50ms Бъзкоскоростно опресняване на екрана
 - 50ms опресняване позволява за точен и бърз температурен контрол.



- Промяна на изход токов или SSR
 - Операторите могат да избират между токов изход или SSR изход.



- Изход за SSR устройство опции за контрол

Операторите могат да избират между ON/OFF, цикличен и фазов контрол използвайки стандартните SSR опции на изхода. Това позволява прецизен и точен контрол с малка консумация.

Метод чрез SSR изход

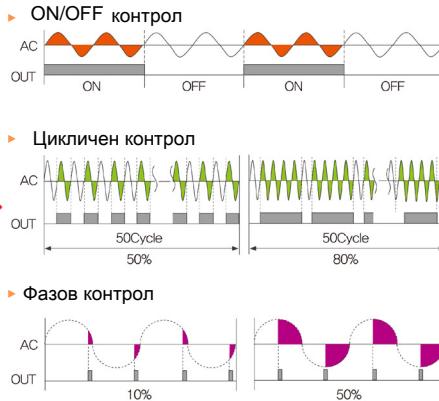

■ Приложения

Точен температурен контрол при например машини за печене на кафе.



(A)	Photoelectric Sensors
(B)	Fiber Optic Sensors
(C)	Door/Area Sensors
(D)	Proximity Sensors
(E)	Pressure Sensors
(F)	Rotary Encoders
(G)	Connectors/ Sockets
(H)	Temperature Controllers
(I)	SSRs / Power Controllers
(J)	Counters
(K)	Timers
(L)	Panel Meters
(M)	Tacho / Speed / Pulse Meters
(N)	Display Units
(O)	Sensor Controllers
(P)	Switching Mode Power Supplies
(Q)	Stepper Motors & Drivers & Controllers
(R)	Graphic/ Logic Panels
(S)	Field Network Devices
(T)	Software

TX4S Series

NEW

LCD Дисплей и PID контрол

■ Характеристики

- Бързоскоростно обработване на информация(50ms)
- Подобрена видимост посредством LCD дисплей
- Поддръжка на комуникационна функция през RS485(Modbus RTU)
- Удобни настройки на параметрите(RS485 комуникация)
Безплатен достъп до изчерпателна и подробна програма за устройството (DAQ master)
- SSR изход/Токов изход с опция за избиране
- SSRP изход(стандартен/фазов/цикличесен с избирателен контрол)
- Компактен дизайн
Намелена дължина с 30% спрямо другите видове термоконтролери



※ Термо подложката се продава отделно

⚠ Please read "Caution for your safety" in operation manual before using.



■ Цялостна програма за управление на устройството

- DAQmaster е цялостна програма за управление.Използва се за настройка на параметри и мониторинг.
- За повече информация посетете www.autonics.com за да изтеглите програмата и наръчника за нея.

< Компютърни спецификации >

Item	Минимални изисквания
Система	IMB PC и компютър с Intel Pentium III и нагоре
ОС	Windows 98/NT/XP/Vista/7/8/10
Памет	256MB или повече
Твърд диск	Повече от 1gb дисково място
Дисплей	1024x768 или по висока резолюция
Други	RS232 серион порт (9 пина) или USB порт

< DAQMaster screen >





■ Допълнителна информация

TX 4 S - 1 4 R

Контролен изход	R	Релеен изход
Захранване	4	100-240VAC 50/60Hz
Допълнителни изходи	1	Алармен изход 1
	2	Алармен изход 1+ Алармен изход 2
	A	Алрм.изход 1 и 2 + Транс. изход
	B	Алрм. изход 1 и 2 + RS485 ком. порт Изход
Големина	S	DIN W48×H48mm
Циферблат	4	9999(4digit)
Продукт	TX	Термоконтролер с LCD дисплей и PID

LCD Display PID Control

■ Спецификации

Series	TX4S	
Захранване	100-240VAC 50/60Hz	
Допустим волтаж	90 to 110% of rated voltage	
Консумация	Max. 8VA	
Дисплей	11 сегментен метод (PV:White.SV:green) Другия дисплей (жълт) с LCD метод	
Големина на знаците	PV(W×H)	6.9×15.3mm
	SV(W×H)	4.1×9.2mm
Видове Входи	RTD	DPT100Ω, Cu50Ω (permissible line resistance max. 5Ω)
	TC	K(CA), J(IC), L(IC), T(CC), R(PR), S(PR)
Точност на дисплея	RTD	• При стайна температура(23C ±5C)
	TC	• Външна температура (PV± 0.5C или +2C)
Контролен Изход	Реле	250VAC 3A 1a
	SSR	Max. 12VDC ± 2V 20mA
	Токов	DC4-20mA or DC0-20mA (load resistance max. 500Ω)
Други Изходи	Алармен, изход	AL1, AL2 Relay: 250VAC 3A 1a
	Транс, Изход	DC4-20mA (load resistance max. 500Ω, output accuracy: ±0.3%F.S.)
	Ком. Изход	RS485 Communication output (Modbus RTU method)
Метод на контрол	ON/OFF control, P, PI, PD, PID control	
Хистерезис	1 до 100C/F (0.1 до 50.0 C/F) варираш	
Пропорции	0.1 до 999.9 C/F	
Време	0 to 9999 sec.	
Производно време (D)	0 to 9999 sec.	
Контролен период (T)	0.5 to 120.0 sec.	
Ръчен рестарт	0.0 to 100.0%	
Период на отчитане	50ms	
Диелектрична сила	3,000VAC 50/60Hz for 1 min. (between all terminals and case)	
Вибрация	0.75mm амплитуда честота 5 to 55Hz(за 1 мин) в всеки X,Y,Z посоки за 2 часа	
Релеен живот	Механичен	OUT, AL1/2: Min. 5,000,000 операции
	Електричен	OUT, AL1/2: Min. 200,000 (250VAC 3A resistance load)
Изолац. съпротивление	Min. 100MΩ (at 500VDC megger)	
Съпротивление на шума	(pulse width 1μs) ±2kV R-phase, S-phase	
Съхранение на памет	Приблизително 10 години	
Работна среда	Температура	-10 to 50°C, storage: -20 to 60°C
	Влажност	35 to 85%RH, storage: 35 to 85%RH
Ниво на защита	IP50 (front panel, IEC standards)	
Вид изолация	Double insulation or reinforced insulation(mark:  , dielectric strength between all terminals and case: 3kV)	
Сертификати	CE  	
Тегло	132g(с кутия)	

※1: When using the unit at low temperature (below 0°C), display cycle is slow.

Control output operates normally.

※2: ○ At room temperature(23°C±5°C)

• TC R(PR), S(PR), below 200°C: (PV ±0.5% or ±3°C, select the higher one) ±1 digit
 , over 200°C: (PV ±0.5% or ±2°C, select the higher one) ±1 digit

• TC L(IC), RTD Cu50Ω: (PV ±0.5% or ±2°C, select the higher one) ±1 digit

○ Out of room temperature range

• TC R(PR), S(PR): (PV ±1.0% or ±5°C, select the higher one) ±1 digit

• TC L(IC), RTD Cu50Ω: (PV ±0.5% or ±3°C, select the higher one) ±1 digit

※3: The weight includes packaging. The weight in parentheses is for unit only.

※Environment resistance is rated at no freezing or condensation.

(A) Photoelectric Sensors

(B) Fiber Optic Sensors

(C) Door/Area Sensors

(D) Proximity Sensors

(E) Pressure Sensors

(F) Rotary Encoders

(G) Connectors/ Sockets

(H) Temperature Controllers

(I) SSRs / Power Controllers

(J) Counters

(K) Timers

(L) Panel Meters

(M) Tacho / Speed / Pulse Meters

(N) Display Units

(O) Sensor Controllers

(P) Switching Mode Power Supplies

(Q) Stepper Motors & Drivers & Controllers

(R) Graphic/ Logic Panels

(S) Field Network Devices

(T) Software

TX4S Series

■ Свързване

OUT
SSR
12VDC±2V 20mA Max.
Current
DC0/4-20mA
Load 500ΩMax.
Relay
250VAC 3A 1a
RESISTIVE LOAD

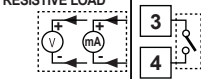

⚠ SOURCE
100-240VAC
50/60Hz 8VA

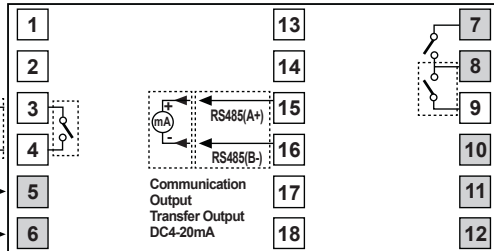

※ Потъмнените терминали са за стандартния модел

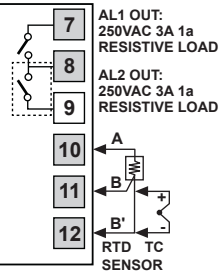

AL1 OUT:
250VAC 3A 1a
RESISTIVE LOAD
AL2 OUT:
250VAC 3A 1a
RESISTIVE LOAD

■ Размери

(unit: mm)

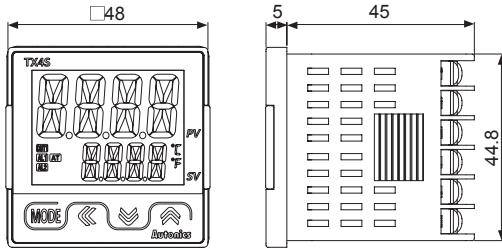

● Панелни размери

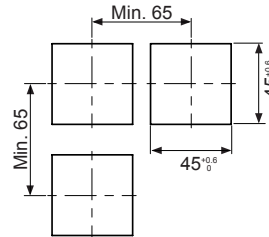

● Конзола

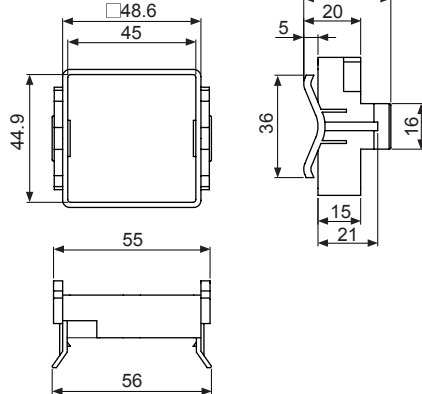

● Капак на терминал(RSAS)

* Продава се отделно

(unit: mm)

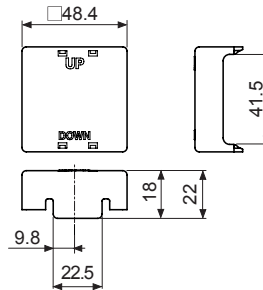

■ Начин на монтаж

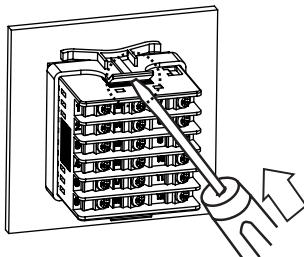

■ Продава се отделно

● SCM-US
(USB Към серен порт)

● EXT-US
(Конверторен кабел)



LCD Display PID Control

Unit Description

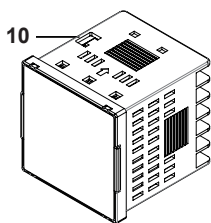
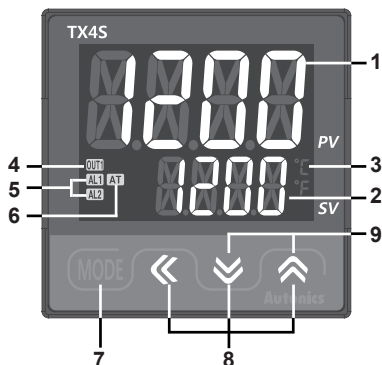

- 1. Measured value (PV) component:**
 RUN mode: Displays current measured value (PV).
 SETTING mode: Displays parameters.
- 2. Setting value (SV) display component:**
 RUN mode: Displays setting value(SV).
 SETTING mode: Displays setting value of parameter.
- 3. Temperature unit(°C/°F) indicator:**
 Displays the set temperature unit as temperature unit [UNIT] of parameter group 2.
- 4. Control output (OUT1) indicator:**
 Turns ON while control output is ON.
 ※Turns ON when MV is over 3.0% at cycle/phase control of SSR drive output method.
- 5. Alarm output (AL1, AL2) indicator:**
 Turns ON when the corresponding alarm output turns ON.
- 6. Auto-tuning indicator:**
 Flashes during auto-tuning every 1 sec.

- 7. MODE key:** Enters parameter group, returns to RUN mode, moves parameters, and saves the setting value.
- 8. Setting value adjustment key:** Enters SV setting mode and move digits.
- 9. Digital input key:**
 Press the \boxplus + \boxminus keys for 3 sec. to execute the digital input key functions which is set at digital input key [d1 -K] of parameter group 2 (RUN/STOP, clear alarm output, auto-tuning).
- 10. PC loader port:**
 It is for serial communication to set parameter and monitoring by DAQMaster installed in PC. Use this for connection EXT-US (converter cable, sold separately) + SCM-US (USB to Serial converter, sold separately).

Parameter Group

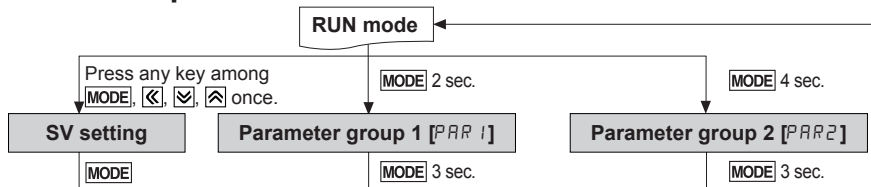

※Order of parameter setup **Parameter group 2** → **Parameter group 1** → **SV setting**

•All parameters are related one another. Set the parameters as above order.

※If there is no key input for 30 sec. while setting SV or the parameters, the new settings are ignored, and the unit will return to RUN mode with previous settings.

※When returning to RUN mode by holding the **MODE** key for over 3 sec., press the **MODE** key within 1 sec. to re-enter the first parameter of previous parameter group.

※Hold the \boxplus + \boxminus + \boxminus keys for 5 sec. in RUN mode, to enter re-set parameter menu. Select 'RES' and all parameters are reset as factory default.

• SV setting

※To change set temperature from 210°C to 250°C

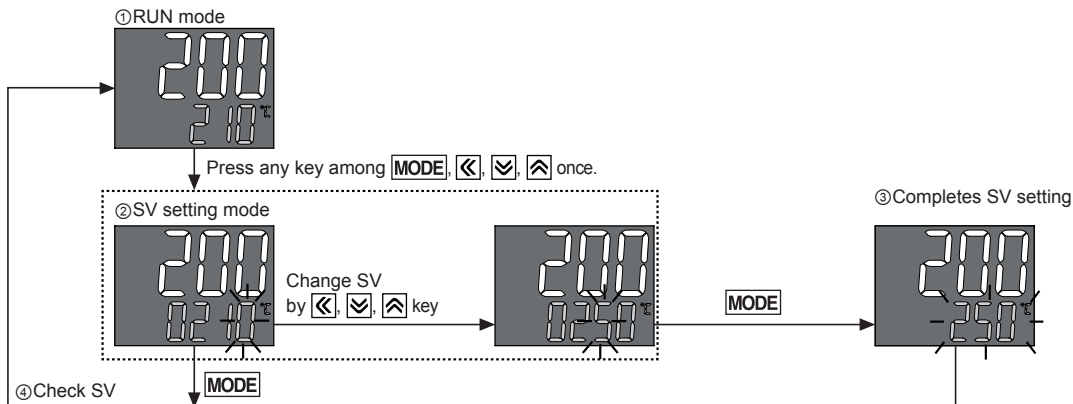

(A) Photoelectric Sensors

(B) Fiber Optic Sensors

(C) Door/Area Sensors

(D) Proximity Sensors

(E) Pressure Sensors

(F) Rotary Encoders

(G) Connectors/ Sockets

(H) Temperature Controllers

(I) SSRs / Power Controllers

(J) Counters

(K) Timers

(L) Panel Meters

(M) Tacho / Speed / Pulse Meters

(N) Display Units

(O) Sensor Controllers

(P) Switching Mode Power Supplies

(Q) Stepper Motors & Drivers & Controllers

(R) Graphic/ Logic Panels

(S) Field Network Devices

(T) Software

TX4S Series

Parameter group 1

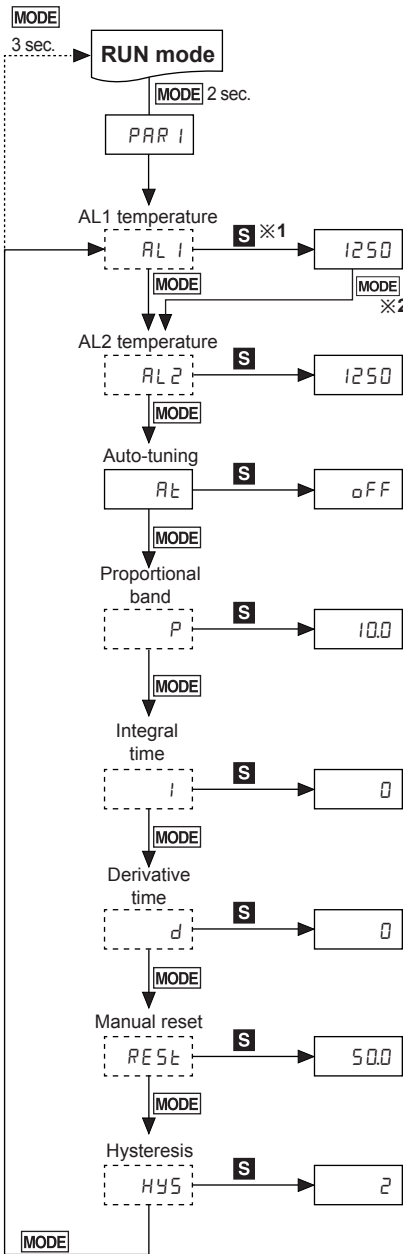

※1: **S**: Press any key among \square , \square , \square .

※2: Press the **MODE** key once after changing the setting value, to save the setting value and move to the next parameter

※Hold the **MODE** key for 3 sec. to save the setting value and return to RUN mode after changing the setting value.

※: Dotted parameters may not appear by model type or other parameter settings.

Setting range: Deviation alarm(- [F.S] to [F.S]).
Absolute value alarm(temperature range)

※Does not appear when AL1/AL2 alarm operation [AL - 1, AL - 2] of parameter group 2 is set as $RM0_15bR□/LbR□$.

※Only alarm output 2 models have [AL 2].

※When setting as ON , the unit starts auto-tuning. After completing, OFF is automatically set.

※During auto-tuning, the auto-tuning indicator flashes (every 1 sec.).

Setting range: 0.1 to 999.9°C/°F

Setting range: 0 to 9999 sec.

※Integral operation will be OFF when the setting value is '0'.

Setting range: 0 to 9999 sec.

※Derivative operation will be OFF when the setting value is '0'.

Setting range: 0.0 to 100.0%

※Only appears in P, PD control.

Setting range: 1 to 100°C/°F (0.1 to 50.0°C/°F)

※Only appears when control method [-Md] of parameter group 2 is set as $ONOFF$.

※Only appears when control method [-Md] of parameter group 2 is set as $P1d$.

LCD Display PID Control

Parameter group 2

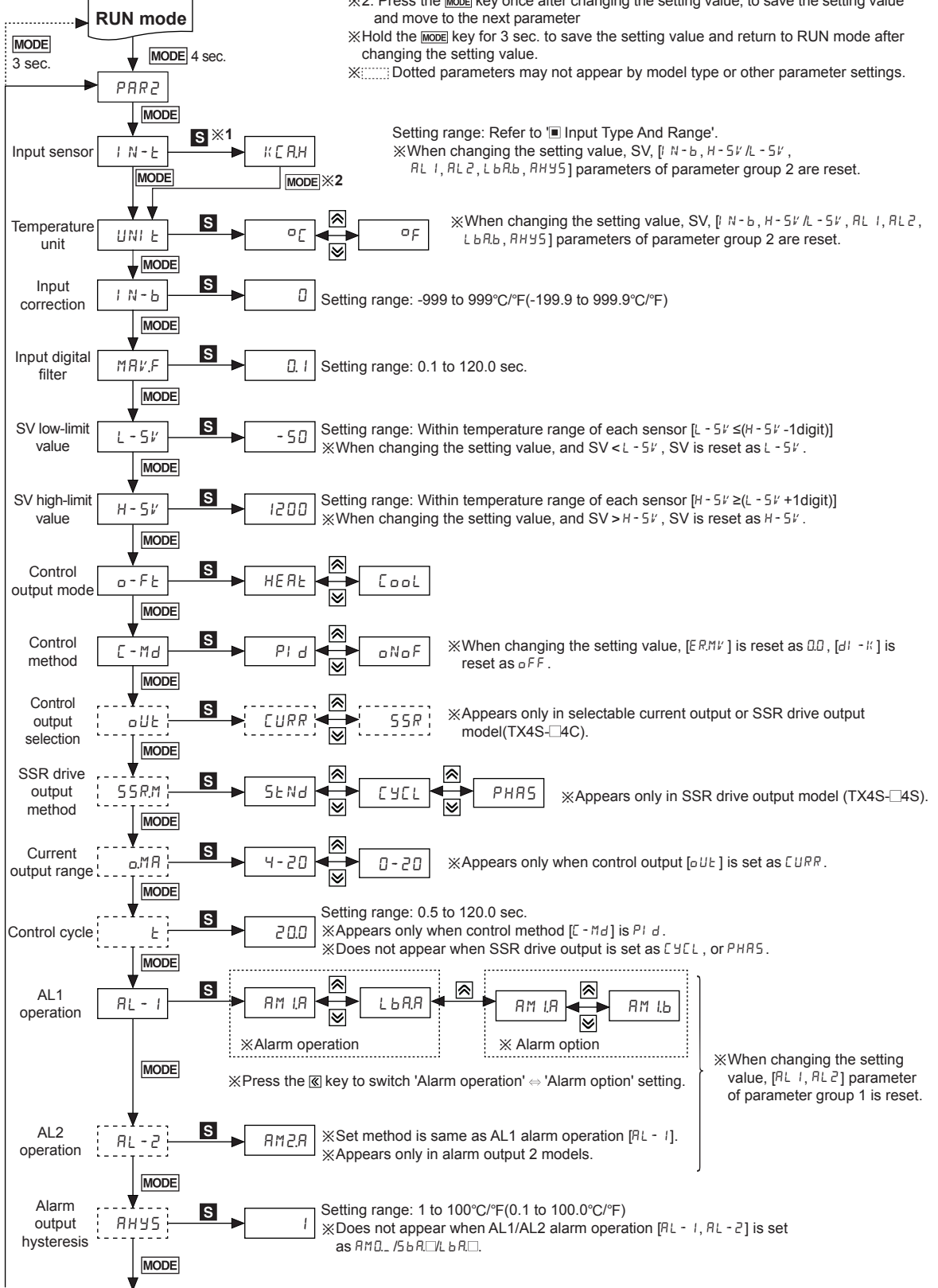

※1: **S**: Press any key among [], [], [].

※2: Press the [MODE] key once after changing the setting value, to save the setting value and move to the next parameter

※Hold the [MODE] key for 3 sec. to save the setting value and return to RUN mode after changing the setting value.

※: Dotted parameters may not appear by model type or other parameter settings.

(A)	Photoelectric Sensors
(B)	Fiber Optic Sensors
(C)	Door/Area Sensors
(D)	Proximity Sensors
(E)	Pressure Sensors
(F)	Rotary Encoders
(G)	Connectors/Sockets
(H)	Temperature Controllers
(I)	SSRs / Power Controllers
(J)	Counters
(K)	Timers
(L)	Panel Meters
(M)	Tacho / Speed / Pulse Meters
(N)	Display Units
(O)	Sensor Controllers
(P)	Switching Mode Power Supplies
(Q)	Stepper Motors & Drivers & Controllers
(R)	Graphic/Logic Panels
(S)	Field Network Devices
(T)	Software

TX4S Series

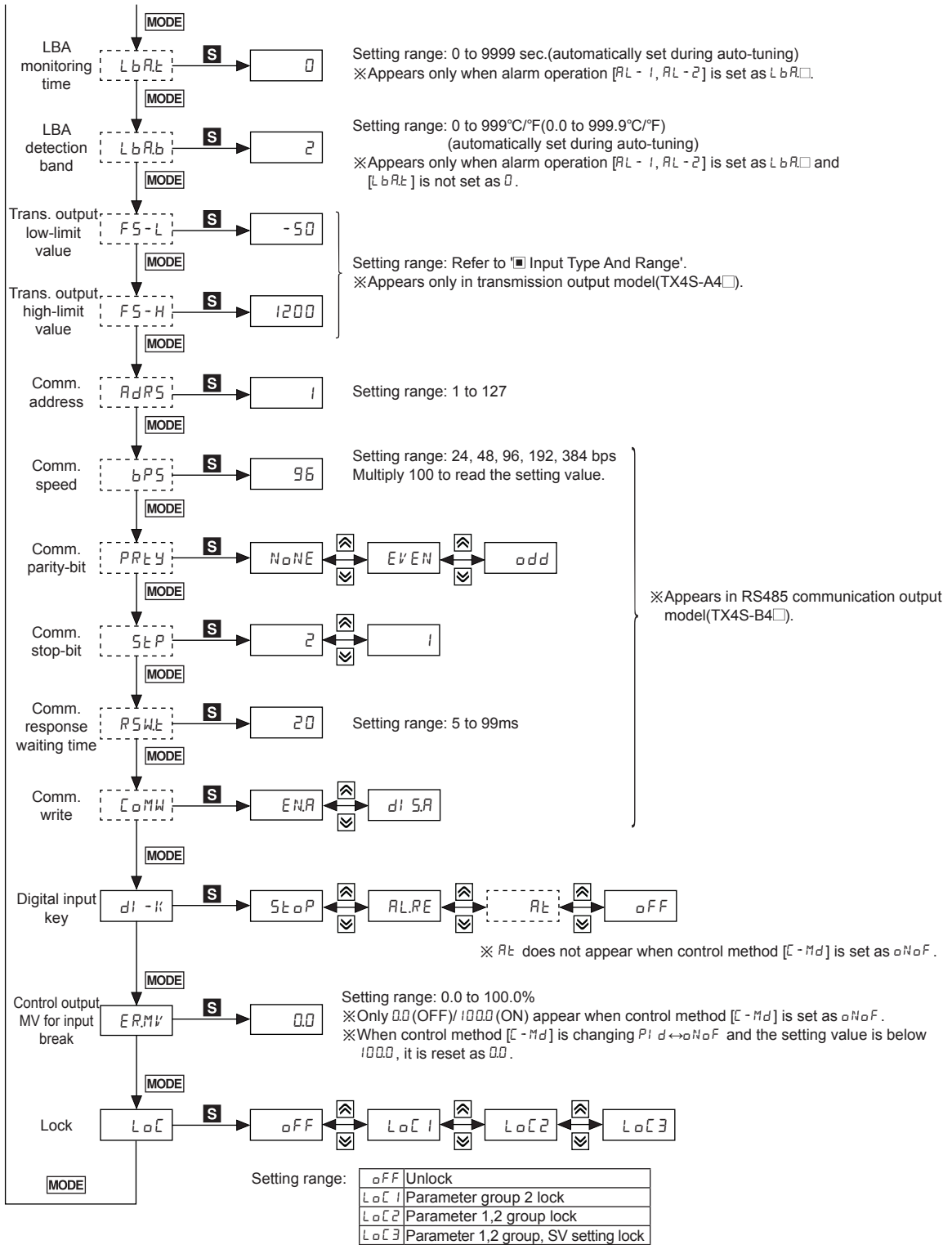

LCD Display PID Control

Input Type And Range

Input type		Decimal point	Display	Input range(°C)	Input range(°F)
Thermocouple	K(CA)	1	KCAH	-50 to 1200	-58 to 2192
		0.1	KCAL	-50.0 to 999.9	-58.0 to 999.9
	J(IC)	1	JICH	-30 to 800	-22 to 1472
		0.1	JICL	-30.0 to 800.0	-22.0 to 999.9
	L(IC)	1	LICH	-40 to 800	-40 to 1472
		0.1	LICL	-40.0 to 800.0	-40.0 to 999.9
	T(CC)	1	TCH	-50 to 400	-58 to 752
		0.1	TCL	-50.0 to 400.0	-58.0 to 752.0
R(PR)	1	RPR	0 to 1700	32 to 3092	
S(PR)	1	SPR	0 to 1700	32 to 3092	
RTD	DPT 100Ω	1	dPcH	-100 to 400	-148 to 752
		0.1	dPcL	-100.0 to 400.0	-148.0 to 752.0
	CU50Ω	1	CUSH	-50 to 200	-58 to 392
		0.1	CUSL	-50.0 to 200.0	-58.0 to 392.0

Factory Default

SV setting

Parameter	Factory default
-	0

Parameter group 1

Parameter	Factory default
RL1	1250
RL2	
RL	OFF
P	10.0
i	0
d	
RESL	50.0
HY5	2

Parameter group 2

Parameter	Factory default	Parameter	Factory default
IN-L	KCAH	AHY5	1
UNI-L	°C	LbAL	0
IN-b	0	LbAb	2
MAVF	0.1	FS-L	-50
L-SV	-50	FS-H	1200
H-SV	1200	AdRS	1
o-FL	HEAL	bPS	96
C-Md	PI d	PRLY	NONE
oUL	CURR	SEp	2
SSRM	SEnd	RSWt	20
oMR	4-20	CoMW	ENR
t	20.0(Relay)	di-k	SEoP
	2.0(SSR one)	ERMV	0.0
RL-1	AM1A	LoC	OFF
RL-2	AM2A		

Error

Display	Description	Troubleshooting
oPEN	Flashes when input sensor is disconnected or sensor is not connected.	Check input sensor status.
HHHH	Flashes when measured value is higher than input range.	When input is within the rated input range, this display disappears.
LLLL	Flashes when measured value is lower than input range.	

(A) Photoelectric Sensors

(B) Fiber Optic Sensors

(C) Door/Area Sensors

(D) Proximity Sensors

(E) Pressure Sensors

(F) Rotary Encoders

(G) Connectors/ Sockets

(H) Temperature Controllers

(I) SSRs / Power Controllers

(J) Counters

(K) Timers

(L) Panel Meters

(M) Tacho / Speed / Pulse Meters

(N) Display Units

(O) Sensor Controllers

(P) Switching Mode Power Supplies

(Q) Stepper Motors & Drivers & Controllers

(R) Graphic/ Logic Panels

(S) Field Network Devices

(T) Software

TX4S Series

Alarm

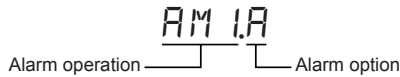

Set both alarm operation and alarm option by combining. Each alarm operates individually in two alarm output models. When the current temperature is out of alarm range, alarm clears automatically. If alarm option is alarm latch or alarm latch and standby sequence 1/2, press digital input key [H] 3 sec., digital input key [d1 - k] of parameter group 2 set as $RLRE$), or turn OFF the power and turn ON to clear alarm.

Alarm operation

Mode	Name	Alarm operation	Description
$AM0$	-	-	No alarm output
$AM1$	Deviation high-limit alarm		If deviation between PV and SV as high-limit is higher than set value of deviation temperature, the alarm output will be ON.
$AM2$	Deviation low-limit alarm		If deviation between PV and SV as low-limit is higher than set value of deviation temperature, the alarm output will be ON.
$AM3$	Deviation high/low-limit alarm		If deviation between PV and SV as high/low-limit is higher than set value of deviation temperature, the alarm output will be ON.
$AM4$	Deviation high/low-limit reserve alarm		If deviation between PV and SV as high/low-limit is higher than set value of deviation temperature, the alarm output will be OFF.
$AM5$	Absolute value high limit alarm		If PV is higher than the absolute value, the output will be ON.
$AM6$	Absolute value low limit alarm		If PV is lower than the absolute value, the output will be ON.
$5bR$	Sensor break alarm	-	It will be ON when it detects sensor disconnection.
LbR	Loop break alarm	-	It will be ON when it detects loop break.

※ H: Alarm output hysteresis [AMH5]

Alarm option

Option	Name	Description
AMa	Standard alarm	If it is an alarm condition, alarm output is ON. If it is a clear alarm condition, alarm output is OFF.
AMb	Alarm latch	If it is an alarm condition, alarm output is ON and maintains ON status. (Alarm output HOLD)
AMc	Standby sequence 1	First alarm condition is ignored and from second alarm condition, standard alarm operates. When power is supplied and it is an alarm condition, this first alarm condition is ignored and from the second alarm condition, standard alarm operates.
AMd	Alarm latch and standby sequence 1	If it is an alarm condition, it operates both alarm latch and standby sequence. When power is supplied and it is an alarm condition, this first alarm condition is ignored and from the second alarm condition, alarm latch operates.
AMe	Standby sequence 2	First alarm condition is ignored and from second alarm condition, standard alarm operates. When re-applied standby sequence and if it is alarm condition, alarm output does not turn ON. After clearing alarm condition, standard alarm operates.
AMf	Alarm latch and standby sequence 2	Basic operation is same as alarm latch and standby sequence 1. It operates not only by power ON/OFF, but also alarm setting value, or alarm option changing. When re-applied standby sequence and if it is alarm condition, alarm output does not turn ON. After clearing alarm condition, alarm latch operates.

※ Condition of re-applied standby sequence for standby sequence 1, alarm latch and standby sequence 1: Power ON
 Condition of re-applied standby sequence for standby sequence 2, alarm latch and standby sequence 2: Power ON, changing set temperature, alarm temperature [RL 1, RL 2] or alarm operation [RL - 1, RL - 2], switching STOP mode to RUN mode.

LCD Display PID Control

•Sensor break alarm

The function that alarm output will be ON when sensor is not connected or when sensor's disconnection is detected during temperature controlling. You can check whether the sensor is connected with buzzer or other units using alarm output contact. It is selectable between standard alarm [5bRR] or alarm latch [5bRb].

• Loop break alarm(LBA)

It checks control loop and outputs alarm by temperature change of the subject. For heating control(cooling control), when control output MV is 100%(0% for cooling control) and PV is not increased over than LBA detection band [LbRb] during LBA monitoring time [LbRt], or when control output MV is 0%(100% for cooling control) and PV is not decreased below than LBA detection band [LbRb] during LBA monitoring time [LbRt], alarm output turns ON.

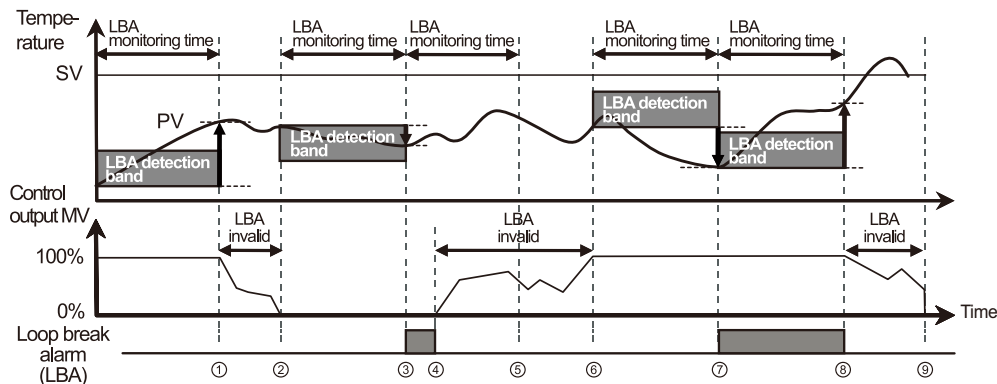

Start control to ①	When control output MV is 100%, PV is increased over than LBA detection band [LbRb] during LBA monitoring time [LbRt].
① to ②	The status of changing control output MV (LBA monitoring time is reset.)
② to ③	When control output MV is 0% and PV is not decreased below than LBA detection band [LbRb] during LBA monitoring time [LbRt], loop break alarm (LBA) turns ON after LBA monitoring time.
③ to ④	Control output MV is 0% and loop break alarm (LBA) turns and maintains ON.
④ to ⑥	The status of changing control output MV (LBA monitoring time is reset.)
⑥ to ⑦	When control output MV is 100% and PV is not increased over than LBA detection band [LbRb] during LBA monitoring time [LbRt], loop break alarm (LBA) turns ON after LBA monitoring time.
⑦ to ⑧	When control output MV is 100% and PV is increased over than LBA detection band [LbRb] during LBA monitoring time [LbRt], loop break alarm (LBA) turns OFF after LBA monitoring time.
⑧ to ⑨	The status of changing control output MV (LBA monitoring time is reset.)

※When executing auto-tuning, LBA detection band [LbRb] and LBA monitoring time are automatically set based on auto tuning value. When alarm operation mode [RL-1, RL-2] is set as loop break alarm(LBA) [LbR□], LBA detection band [LbRb] and LBA monitoring time [LbRt] parameter is displayed.

(A) Photoelectric Sensors

(B) Fiber Optic Sensors

(C) Door/Area Sensors

(D) Proximity Sensors

(E) Pressure Sensors

(F) Rotary Encoders

(G) Connectors/Sockets

(H) Temperature Controllers

(I) SSRs / Power Controllers

(J) Counters

(K) Timers

(L) Panel Meters

(M) Tacho / Speed / Pulse Meters

(N) Display Units

(O) Sensor Controllers

(P) Switching Mode Power Supplies

(Q) Stepper Motors & Drivers & Controllers

(R) Graphic/Logic Panels

(S) Field Network Devices

(T) Software

TX4S Series

■ Functions

1. Input correction [I N - b]

Controller itself does not have errors but there may be error by external input temperature sensor. This function is for correcting this error. E.g.) If actual temperature is 80°C but controller displays 78°C, set input correction value [I N - b] as '2' and controller displays 80°C. ※As the result of input correction, if current temperature value (PV) is over each temperature range of input sensor, it displays HHHH or LLLL.

2. Input digital filter [M V . F]

If current temperature (PV) is fluctuating repeatedly by rapid change of input signal, it reflects to MV and stable control is impossible. Therefore, digital filter function stabilizes current temperature value. For example, set input digital filter value as 0.4 sec, and it applies digital filter to input values during 0.4 sec and displays these values. Current temperature may be different by actual input value.

3. SSR drive output method (SSRP function) [5 5 R M]

- SSRP function is selectable one of standard ON/OFF control, cycle control, phase control by utilizing standard SSR drive output.
- This function parameter appears only in SSR drive output model (TX4S-□4S).
- Realizing high accuracy and cost effective temperature control with both current output (4-20mA) and linear output(cycle control and phase control)
- Select one of standard ON/OFF control [5 t N d], cycle control [C Y C L], phase control [P H R S] at 5 5 R M parameter of parameter group 2. For cycle control, connect a zero cross turn-on SSR or random turn-on SSR. For phase control, connect random turn-on SSR.

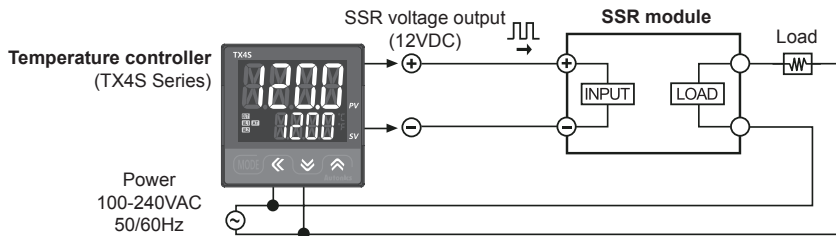

※When selecting cycle or phase control mode, **the power supply for a load and a temperature controller must be the same.**

※Control cycle [t] is able to set only when control method [C - M d] of parameter group 2 is set as P i d and SSR drive output method [5 5 R M] is set as 5 t N d.

※In case of selectable current output or SSR drive output model(TX4S-□4C), this parameter does not appear. Standard ON/OFF control by SSR is only available.

1) Standard ON/OFF control [5 t N d]

Controls ON (100% output)/OFF (0% output) as same as standard relay output.

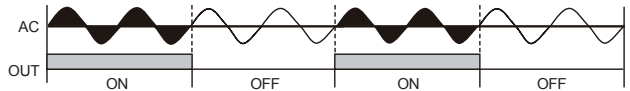

2) Cycle control [C Y C L]

Controls the load by repeating output ON / OFF according to the rate of output within setting cycle based on certain period (50-cycle).

Control accuracy is almost the same with phase control's.

This control has improved ON/OFF noise than phase control's due to zero cross type which turns ON/OFF at zero point of AC.

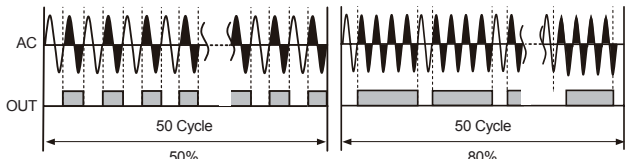

3) Phase control [P H R S]

Controls the load by controlling the phase within AC half cycle. Serial control is available.

Must use random turn-on SSR for this mode.

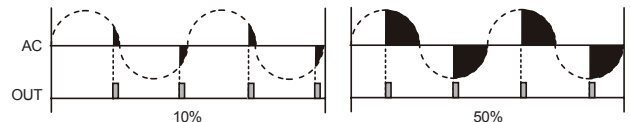

4. Current output range [a . M A]

In case of selectable current output or SSR drive output model(TX4S-□4C), when control output [a U E] parameter group 2 is set as [C U R R], you can select high/low-limit range, 4-20mA [4 - 2 0] or 0-20mA [0 - 2 0] of current output.

5. Hysteresis [H Y S]

Set interval between ON and OFF of control output for ON/OFF control.

•If hysteresis is too narrow, hunting(oscillation, chattering) could occur due to external noise.

•In case of ON / OFF control mode, even if PV reaches stable status, there still occurs hunting. It could be due to hysteresis [H Y S] setting value, load's response characteristics or sensor's location. In order to reduce hunting to a minimum, it is required to take into following factors consideration when designing temp. controlling; proper Hysteresis [H Y S], heater's capacity, thermal characteristics, sensor's response and location.

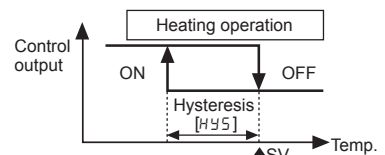

LCD Display PID Control

6. Manual reset [RESE]

When selecting P/PD control mode, certain temperature difference exists even after PV reaches stable status because heater's rising and falling time is inconsistent due to thermal characteristics of controlled objects, such as heat capacity, heater capacity. This temperature difference is called offset and manual reset [RESE] function is to set/correct offset.

When PV and SV are equal, reset value is 50.0%. After control is stable, PV is lower than SV, reset value is over 50.0% or PV is higher than SV, reset value is below 50.0%.

●Manual reset [RESE] by control result

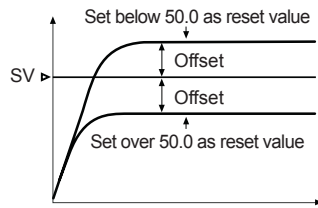

7. Digital input key [OK] + [3 sec.] [d1 - k]

Parameter	Operation
OFF	It does not use digital input key function.
RUN/STOP	Pauses control output. Auxiliary output (except loop break alarm, sensor break alarm)except Control output operates as setting. Hold the digital input keys for 3 sec. to restart.
Clear alarm	Clears alarm output by force. (only when alarm option is alarm latch, or alarm latch and standby sequence 1/2.) This function is applied when present value is out of alarm operation range but alarm output is ON. Alarm operates normally right after clearing alarm.
Auto-tuning	Starts/Stops auto-tuning. This function is same as auto-tuning [RE] of parameter group 1. (You can start auto-tuning [RE] of parameter group 1 and stop it by digital input key.) ※ This parameter RE appears only when control method [C-Md] parameter group 2 is set as PId. When control method [C-Md] parameter group 2 is set as ONoF, this parameter is changed as oFF.

8. Control output MV for input break [ERMV]

When input sensor is break, set control output MV.

When control method [C-Md] of parameter group 2 is set as ONoF, set control output MV as 0.0 (OFF) or 100.0 (ON). When control method [C-Md] is set as PId, setting range for control output MV is 0.0 to 100.0.

RS485 Communication Output

Applicable for models with RS485 communication output through option output(TX4S-B4□). Please refer to 'Ordering Information'.

1. Communication Specifications

Com. protocol	Modbus RTU	Com. speed	2400, 4800, 9600, 19200, 38400 bps
Applied standard	EIA RS485		
Max. connections	31 units(address: 1 to 99)	Start-bit	1-bit fixed
Com. method	2-wire half duplex	Data-bit	8-bit fixed
Synchronization method	Asynchronous	Parity-bit	None, Even, Odd
Com. distance	Within 800m	Stop-bit	1, 2Bit
Com. response time	5 to 99ms		

2. Modbus Mapping Table

2-1. Read Coil Status (Func 01) / Force Single Coil (Func 05) [Func: 01/05, R/W: R/W]

No.(Address)	Type	Description	Setting/Display range	Unit	Default
00001(0000)	RUN/STOP	Control output run/stop	0: RUN 1: St oP	-	St oP
00002(0001)	AT	Auto-tuning run/stop	0: oFF 1: oN	-	oFF
00003(0003)	Alarm Reset	Alarm output clear	0: oFF 1: oN	-	oFF
00004 to 000050	Reserved				

2-2. Read Discrete Inputs(Func 02) [Func: 02, R/W: R]

No.(Address)	Type	Description	Setting/Display range	Unit	Default
100001(0000)	°C indicator	Unit indicator	0: OFF 1: ON	-	-
100002(0001)	°F indicator	Unit indicator	0: OFF 1: ON	-	-
100003(0002)	OUT indicator	Control output indicator	0: OFF 1: ON	-	-
100004(0003)	AT indicator	Auto-tuning indicator	0: OFF 1: ON	-	-
100005(0004)	AL1 indicator	Alarm output 1 indicator	0: OFF 1: ON	-	-
100006(0005)	AL2 indicator	Alarm output 2 indicator	0: OFF 1: ON	-	-
100006 to 100050	Reserved				

(A)	Photoelectric Sensors
(B)	Fiber Optic Sensors
(C)	Door/Area Sensors
(D)	Proximity Sensors
(E)	Pressure Sensors
(F)	Rotary Encoders
(G)	Connectors/ Sockets
(H)	Temperature Controllers
(I)	SSRs / Power Controllers
(J)	Counters
(K)	Timers
(L)	Panel Meters
(M)	Tacho / Speed / Pulse Meters
(N)	Display Units
(O)	Sensor Controllers
(P)	Switching Mode Power Supplies
(Q)	Stepper Motors & Drivers & Controllers
(R)	Graphic/ Logic Panels
(S)	Field Network Devices
(T)	Software

TX4S Series

2-3. Read Input Registers (Func 04) [Func:02, R/W : R]

No.(Address)	Type	Description	Setting/Display range	Unit	Default	
300001 to 300100	Reserved					
300101(0064)	-	Product number H	-	-	Dedicated model number	
300102(0065)	-	Product number L	-	-	Dedicated model number	
300103(0066)	-	Hardware version	-	-	□	
300104(0067)	-	Software version	-	-	□	
300105(0068)	-	Model 1	-	-	"TX"	
300106(0069)	-	Model 2	-	-	"4"	
300107(006A)	-	Model 3	-	-	"S"	
300108(006B)	-	Model 4	-	-	"14"	
300109(006C)	-	Model 5	-	-	"R"	
300110(006D)	-	Model 6	-	-	" "	
300111(006E)	-	Model 7	-	-	" "	
300112(006F)	-	Model 8	-	-	" "	
300113(0070)	-	Model 9	-	-	" "	
300114(0071)	-	Model 10	-	-	" "	
300115(0072)	-	Reserved	-	-	-	
300116(0073)	-	Reserved	-	-	-	
300117(0074)	-	Reserved	-	-	-	
300118(0075)	-	Coil status start address	-	-	0000	
300119(0076)	-	Coil status quantity	-	-	0	
300120(0077)	-	Input status start address	-	-	0000	
300121(0078)	-	Input status quantity	-	-	0	
300122(0079)	-	Holding register start address	-	-	0000	
300123(007A)	-	Holding register quantity	-	-	0	
300124(007B)	-	Input register start address	-	-	0000	
300125(007C)	-	Input register quantity	-	-	0	
300127 to 300200	Reserved					
301001(03E8)	PV	Present value	-1999 to 9999	°C/°F	-	
301002(03E9)	DOT	Decimal point location	0:0, 1:00, 2:000, 3:0000	-	-	
301003(03EA)	UNIT	Display unit	0: °C, 1: °F	-	-	
301004(03EB)	SV	Setting value	Within L - 5V to H - 5V	°C/°F	0	
301005(03EC)	°C indicator	Front indicator	Unit indicator	0: OFF 1: ON	-	-
	°F indicator		Unit indicator	0: OFF 1: ON	-	-
	OUT indicator		Control output indicator	0: OFF 1: ON	-	-
	AT indicator		Auto-tuning indicator	0: OFF 1: ON	-	-
	AL1 indicator		Alarm output 1 indicator	0: OFF 1: ON	-	-
	AL2 indicator	Alarm output 2 indicator	0: OFF 1: ON	-	-	
310006 to 310050	Reserved					

2-4. Read Holding Register (Func 03)/Preset Single Register (Func 06)/Preset Multiple Registers (Func 16) [Func:03/06/16, R/W : R/W]

2-4-1. SV setting

No.(Address)	Parameter	Description	Setting/Display range	Unit	Default
400001(0000)	Set value	SV setting value	Within L - 5V to H - 5V	°C/°F	0
400002 to 400050	Reserved				

2-4-2. Parameter group 1 [PRR 1]

No.(Address)	Parameter	Description	Setting/Display range	Unit	Default
400051(0032)	RL 1	AL1 temperature	Deviation temperature: -F.S. to F.S.	°C/°F	1250
400052(0033)	RL 2	AL2 temperature	Absolute value alarm: Temperature range		
400053(0034)	RE	Auto-tuning	0: OFF 1: ON	-	OFF
400054(0035)	P	Proportional band	1 to 9999: 0.1 to 9999	°C/°F	100
400055(0036)	I	Integral time	0 to 9999: 0 to 9999	Sec.	0
400056(0037)	d	Derivative time	0 to 9999: 0 to 9999	Sec.	0
400057(0038)	RESL	Manual reset	0 to 1000: 00 to 1000	%	500
400058(0039)	HYS	Hysteresis	1 to 100(1 to 500): 1 to 100(0.1 to 50.0)	-	2
400059 to 400100	Reserved				

LCD Display PID Control

2-4-3. Parameter group 2 [PAR2]

No.(Address)	Parameter	Description	Setting/Display range	Unit	Default
400101(0064)	IN-E	Input sensor	Refer to 'Input Type And Range'	-	ICRH
400102(0065)	UNIT	Temperature unit	0: °C, 1: °F	-	°C
400103(0066)	IN-b	Input correction	-999 to 999(-1999 to 9999): -999 to 999(-999 to 999.9)	-	0
400104(0067)	MAVF	Input digital filter	1 to 1200: 0.1 to 120.0	Sec.	0.1
400105(0068)	L-SV	SV low-limit value	Refer to 'Input Type And Range'	°C/°F	-5.0
400106(0069)	H-SV	SV high-limit value			120.0
400107(006A)	o-Fe	Control output mode	0: HEARt, 1: CoOL	-	HEARt
400108(006B)	C-Md	control method	0: Pid, 1: oNoF	-	Pid
400109(006C)	oUt	Control output selection	0: SSR, 1: CURR	-	CURR
400110(006D)	SSRM	SSR drive output method	0: SEnD, 1: CYCL, 2: PHAS	-	SEnD
400111(006E)	oMR	Current output range	0: 4-20, 1: 0-20	-	4-20
400112(006F)	t	Control cycle	5 to 1200: 0.5 to 120.0	Sec.	20.0 2.0
400113(0070)	AL-1	AL1 operation	00: AMO., 10 to 15: AMIA to AMIF, ... 60 to 65: AM6A to AM6F, 70: 5bAA, 71: 5bAb, 80: LbAA, 81: LbAb	-	AMIA
400114(0071)	AL-2	AL2 operation		-	AM2A
400115(0072)	AHYS	Alarm output hysteresis	1 to 100(1 to 500): 1 to 100(0.1 to 50.0)	-	1
400116(0073)	LbALt	LBA detection time	0 to 9999: 0 to 9999	Sec.	0
400117(0074)	LbAb	LBA detection band	0 to 999(0 to 9999): 0 to 999(0.0 to 999.9)	°C/°F	2
400118(0075)	F5-L	Trans. output low-limit value	Refer to 'Input Type And Range'.	-	-5.0
400119(0076)	F5-H	Trans. output high-limit value		-	120.0
400120(0077)	AdRS	Com. address	1 to 127: 1 to 127	-	1
400121(0078)	bPS	Com. speed	0: 24, 1: 48, 2: 96, 3: 192, 4: 384	-	96
400122(0079)	PRtY	Com. parity bit	0: NoNE, 1: EVEN, 2: odd	-	NoNE
400123(007A)	StP	Com. stop bit	0: 1, 1: 2	-	2
400124(007B)	R5Wt	Com. response waiting time	5 to 99: 5 to 99	ms	20
400125(007C)	CoMW	Com. write	0: ENA, 1: dISA	-	ENA
400126(007D)	di-K	Digital input key	0: oFF, 1: St oP, 2: ALRE, 3: Rt	-	St oP
400127(007E)	ERMV	Control output MV for input break	0 to 1000: 0.0 (OFF) to 100.0 (ON)	%	0.0
400128(007F)	LoC	Lock	0: oFF, 1: LoC1, 2: LoC2, 3: LoC3	-	oFF
400129 to 400150	Reserved				

■ Proper Usage

1. Please separate the unit wiring from high voltage lines or power lines to prevent inductive noise.
2. For crimp terminal, select following shaped terminal (M3).

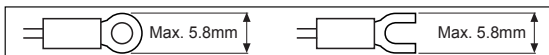

3. Install a power switch or circuit breaker to control the power supply.
4. The power switch or circuit breaker should be installed where it is easily accessible by the user.
5. The unit is for temperature controller. Do not use the unit as volt-meter or ampere-meter.
6. When using RTD temperature sensor, must wire it as 3-wire type. If cable is extended, use 3 wires which are same thickness as the line. It might cause the deviation of temperature when line resistance is different.
7. If power line and input signal line are close each other, install line filter for noise protection at power line and use shielded input signal line.
8. Keep away from the high frequency instruments.(High frequency welding machine & sewing machine, large capacity SCR controller).
9. When supplying the measured input, the unit displays HHHH or LLLL, the measured input may have problem. Turn OFF the power to the unit and check the line.
10. This unit may be used in the following environments.
 - ① It shall be used indoor.
 - ② Altitude up to 2,000m.
 - ③ Pollution degree 2.
 - ④ Installation category II.

(A) Photoelectric Sensors

(B) Fiber Optic Sensors

(C) Door/Area Sensors

(D) Proximity Sensors

(E) Pressure Sensors

(F) Rotary Encoders

(G) Connectors/ Sockets

(H) Temperature Controllers

(I) SSRs / Power Controllers

(J) Counters

(K) Timers

(L) Panel Meters

(M) Tacho / Speed / Pulse Meters

(N) Display Units

(O) Sensor Controllers

(P) Switching Mode Power Supplies

(Q) Stepper Motors & Drivers & Controllers

(R) Graphic/ Logic Panels

(S) Field Network Devices

(T) Software