

BTS Series Ultra-compact Amplifier Built-in Type

Ultra-compact, Amplifier Built-in Type

Feature

- Ultra-slim width of only 7.2mm
 - W7.2×H18.6×L9.5mm (through-beam type)
 - W7.2×H24.6×L10.8mm (retroreflective type, convergent reflective type)
- Detection methods and minimum target size
 - Through-beam type (BTS1M): Ø2mm
 - Retroreflective type (BTS200): Ø2mm (at distance 100mm)
 - Convergent reflective type (BTS15/BTS30): Ø0.15mm (at distance 10mm)
- ※Detecting distance may vary by environmental factors
- Maximum detection distance: 1m (through-beam type)
- Stability indicator (red LED) and operation indicator (green LED)
- Stainless steel 304 mounting brackets
- IP67 protection structure (IEC standard)

⚠ Please read "Safety Considerations" in operation manual before using.

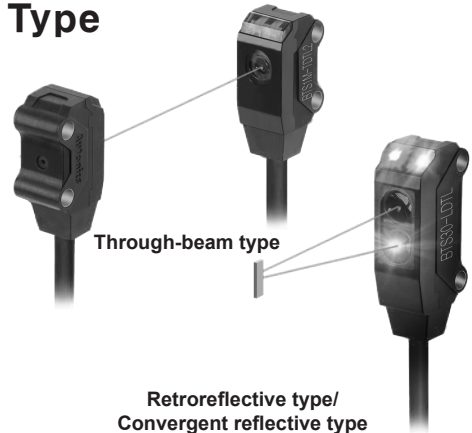

Specifications

Model	NPN open collector output	BTS1M-TDTL	BTS1M-TDTD	BTS200-MDTL	BTS200-MDTD	BTS30-LDTL	BTS30-LDTD	BTS15-LDTL	BTS15-LDTD
	PNP open collector output	BTS1M-TDTL-P	BTS1M-TDTD-P	BTS200-MDTL-P	BTS200-MDTD-P	BTS30-LDTL-P	BTS30-LDTD-P	BTS15-LDTL-P	BTS15-LDTD-P
Sensing type	Through-beam type			Retroreflective type		Convergent reflective type			
Sensing distance	1m			10 to 200mm ^{*1}		5 to 30mm ^{*2}		5 to 15mm ^{*2}	
Sensing target	Opaque material of max. Ø2mm			Opaque material of max. Ø27mm		Opaque material, Translucent materials			
Min. sensing target	Opaque material of Ø2mm			Opaque material of Ø2mm ^{*3} (sensing distance 100mm)		Ø0.15mm (sensing distance 10mm)			
Hysteresis distance	—			—		Max. 15% of maximum sensing distance			
Response time	Max. 1ms								
Power supply	12-24VDC \pm 10% (ripple P-P: max. 10%)								
Current consumption	Max. 20mA (in case of through-beam type, this value is for each emitter and receiver)								
Light source	Red LED (650nm)								
Operation mode	Light ON	Dark ON	Light ON	Dark ON	Light ON	Dark ON	Light ON	Dark ON	Dark ON
Control output	NPN or PNP open collector output ·Load voltage: max. 26.4VDC \pm ·Load current: max. 50mA ·Residual voltage - NPN: max. 1VDC \pm , PNP: max. 2VDC								
Protection circuit	Power reverse polarity protection circuit, output short over current protection circuit								
Indicator	Operation indicator: red LED, stability indicator: green LED								
Connection	Cable type								
Insulation resistance	Over 20MΩ (at 500VDC megger)								
Noise immunity	\pm 240V the square wave noise (pulse width: 1μs) by the noise simulator								
Dielectric strength	1,000VAC 50/60Hz for 1 min								
Vibration	1.5mm amplitude at frequency of 10 to 55Hz (for 1 min) in each X, Y, Z direction for 2 hours								
Shock	500m/s ² (approx. 50G) in each X, Y, Z direction for 3 times								
Environment	Ambient illumination	Sunlight: max. 10,000lx, incandescent lamp: max. 3,000lx (receiver illumination)							
	Ambient temperature	-20 to 55°C, storage: -30 to 70°C							
	Ambient humidity	35 to 85%RH, storage: 35 to 85%RH							
Protection structure	IP67 (IEC standard)								
Material	Case: polybutylene terephthalate, sensing part: polymethyl methacrylate, bracket: stainless steel 304, Bolt: carbon steel wire for cold heading (SWCH10A)								
Cable	Ø2.5mm, 3-wire, 2m (emitter of through-beam type: Ø2.5mm, 2-wire, 2m) (AWG 28, core wire diameter: 0.08mm, number of cores: 19, insulator out diameter: Ø0.9mm)								
Accessory	Bracket A: 2, sub-bracket for through-beam type: 2, M2 bolt: 4			Reflector (MS-6), bracket A, Sub-bracket for reflective type, M2 bolt: 2		Bracket A, sub-bracket for reflective type, M2 bolt: 2			
Approval	CE								
Weight ^{*4}	Approx. 90g (approx. 40g)			Approx. 70g (approx. 25g)					

- ※1: The sensing distance is specified with using the MS-6 reflector. The distance between the sensor and the reflector should be set over 0.1m. When using reflective tapes, the Reflectivity vary by the size of the tape. Please refer to the 'Reflectivity by Reflective Tape Model' table before using the tape.
- ※2: Non-glossy white paper 50×50mm.
- ※3: It will vary by the installation environment and sensing conditions. Please refer to the 'Conditions of min. sensing target and installations (retroreflective type)'.
- ※4: The weight includes packaging. The weight in parenthesis is for unit only.
- ※The temperature or humidity mentioned in Environment indicates a non freezing or condensation.

(A)	Photoelectric Sensors
(B)	Fiber Optic Sensors
(C)	Door/Area Sensors
(D)	Proximity Sensors
(E)	Pressure Sensors
(F)	Rotary Encoders
(G)	Connectors/ Connector Cables/ Sensor Distribution Boxes/Sockets
(H)	Temperature Controllers
(I)	SSRs / Power Controllers
(J)	Counters
(K)	Timers
(L)	Panel Meters
(M)	Tacho / Speed / Pulse Meters
(N)	Display Units
(O)	Sensor Controllers
(P)	Switching Mode Power Supplies
(Q)	Stepper Motors & Drivers & Controllers
(R)	Graphic/ Logic Panels
(S)	Field Network Devices
(T)	Software

■ Feature Data

◎ Through-beam type

- BTS1M-TDTL / BTS1M-TDTL-P

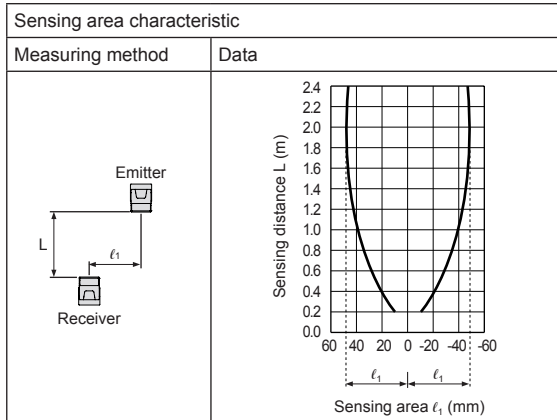

◎ Retroreflective type

- BTS200-MDTD / BTS200-MDTD-P

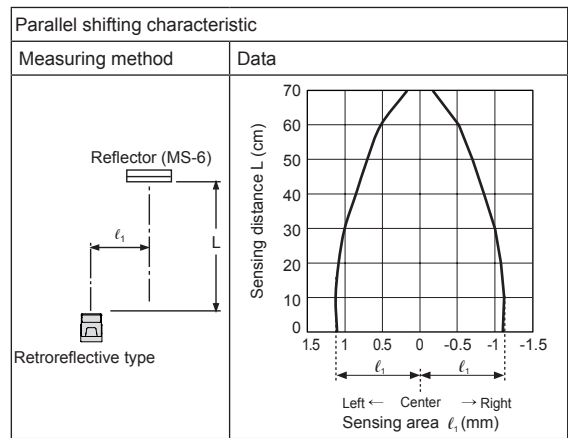

◎ Retroreflective type

- BTS200-MDTD / BTS200-MDTD-P

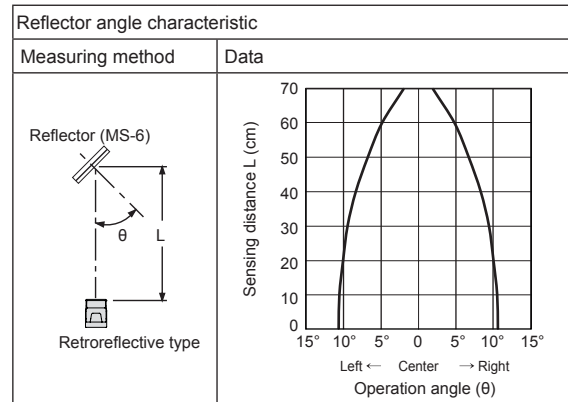
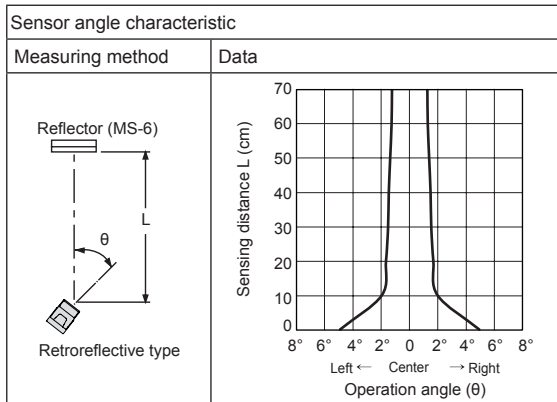

◎ Convergent reflective type

- BTS30-LDTL / BTS30-LDTL-P

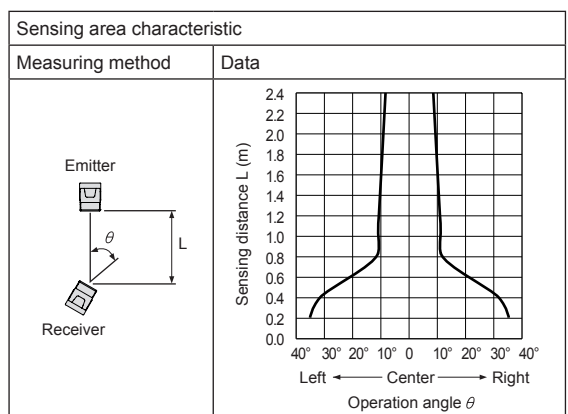
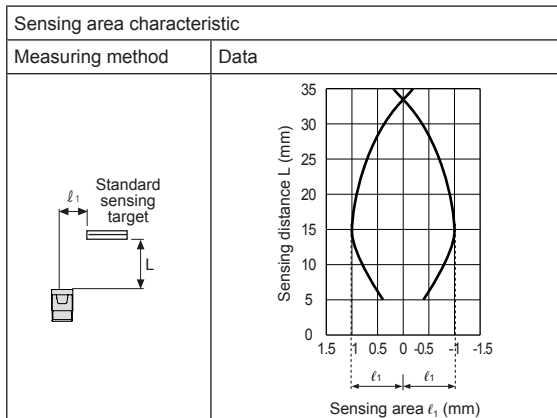

Ultra-compact Amplifier Built-in Type

■ Connections

• Through-beam type

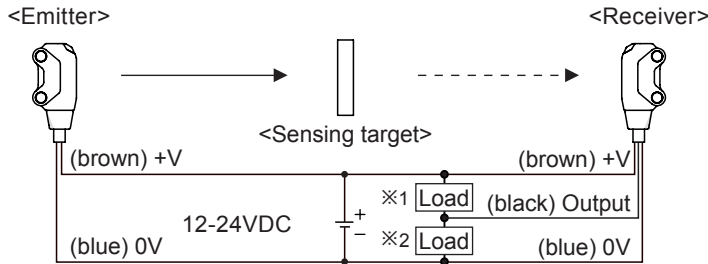

※1: Load connection for NPN output

※2: Load connection for PNP output

• Retroreflective type

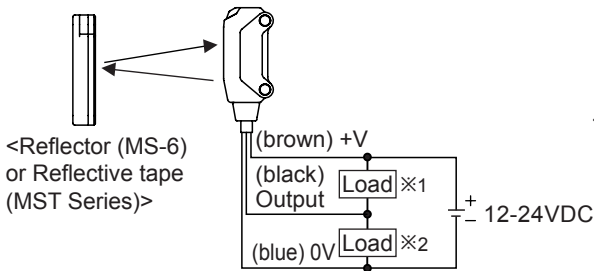

• Convergent reflective type

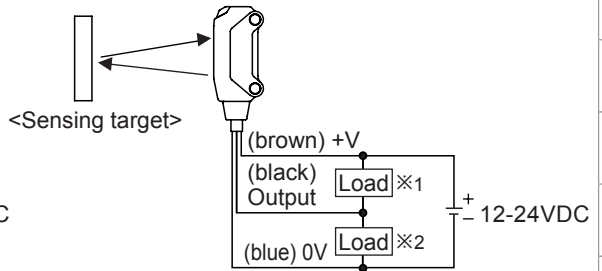

■ Control Output Circuit Diagram

• NPN open collector output

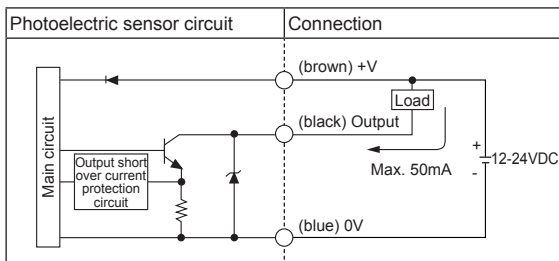

• PNP open collector output

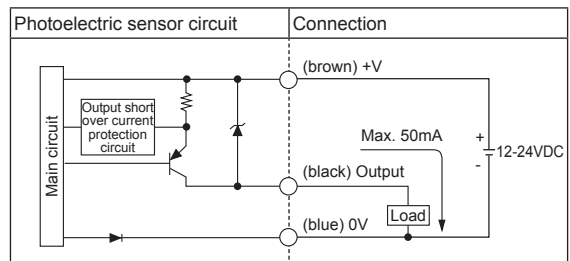

(A) Photoelectric Sensors

(B) Fiber Optic Sensors

(C) Door/Area Sensors

(D) Proximity Sensors

(E) Pressure Sensors

(F) Rotary Encoders

(G) Connectors/ Connector Cables/ Sensor Distribution Boxes/Sockets

(H) Temperature Controllers

(I) SSRs / Power Controllers

(J) Counters

(K) Timers

(L) Panel Meters

(M) Tacho / Speed / Pulse Meters

(N) Display Units

(O) Sensor Controllers

(P) Switching Mode Power Supplies

(Q) Stepper Motors & Drivers & Controllers







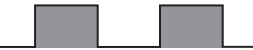

(R) Graphic/ Logic Panels

(S) Field Network Devices

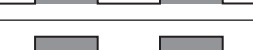
(T) Software

BTS Series

■ Operation Mode

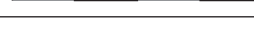
Operation mode	Light ON	Dark ON
Receiver operation	Received light Interrupted light 	Received light Interrupted light 
Operation indicator (red LED)	ON  OFF 	ON  OFF 
Transistor output	ON  OFF 	ON  OFF 

■ Dimensions

● Through-beam type

(unit: mm)

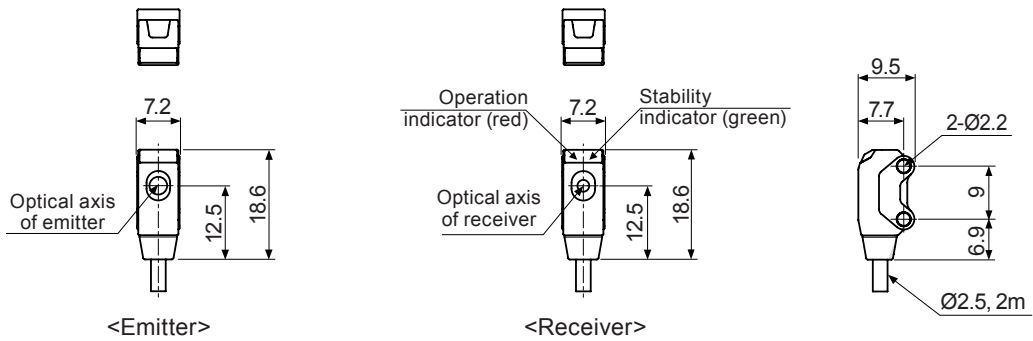

● Retroreflective type / Convergent reflective type

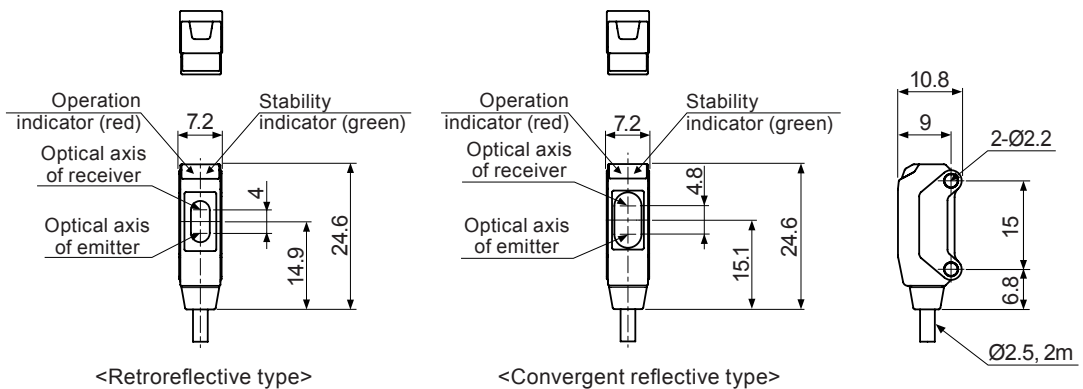

Ultra-compact Amplifier Built-in Type

• Bracket A

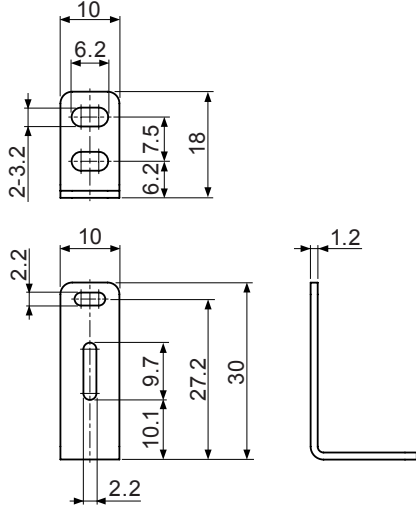

• Bracket B (sold separately)

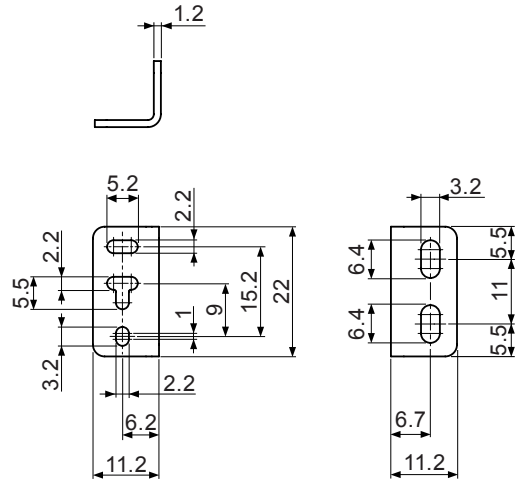

• Sub-bracket for through-beam type

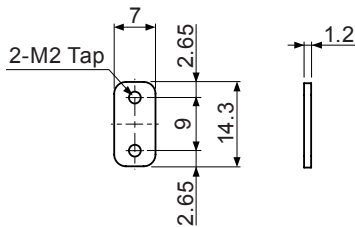

• Sub-bracket for reflective type

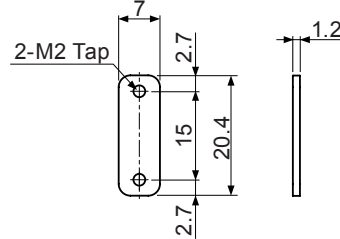

※The sub-bracket for each sensing type is included bracket A (B).

• Reflector (MS-6)

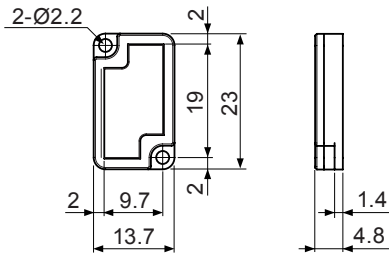

• Slit (BTS1M-ST, sold separately)

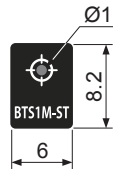

• Reflective tape (sold separately)

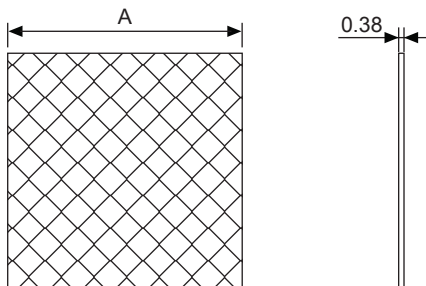

(unit: mm)

Model	A
MST-50-10	<input type="checkbox"/> 50
MST-100-5	<input type="checkbox"/> 100
MST-200-2	<input type="checkbox"/> 200

(A) Photoelectric Sensors

(B) Fiber Optic Sensors

(C) Door/Area Sensors

(D) Proximity Sensors

(E) Pressure Sensors

(F) Rotary Encoders

(G) Connectors/ Connector Cables/ Sensor Distribution Boxes/Sockets

(H) Temperature Controllers

(I) SSRs / Power Controllers

(J) Counters

(K) Timers

(L) Panel Meters

(M) Tacho / Speed / Pulse Meters

(N) Display Units

(O) Sensor Controllers

(P) Switching Mode Power Supplies

(Q) Stepper Motors & Drivers & Controllers

(R) Graphic/ Logic Panels

(S) Field Network Devices

(T) Software

■ Operating Timing Diagram

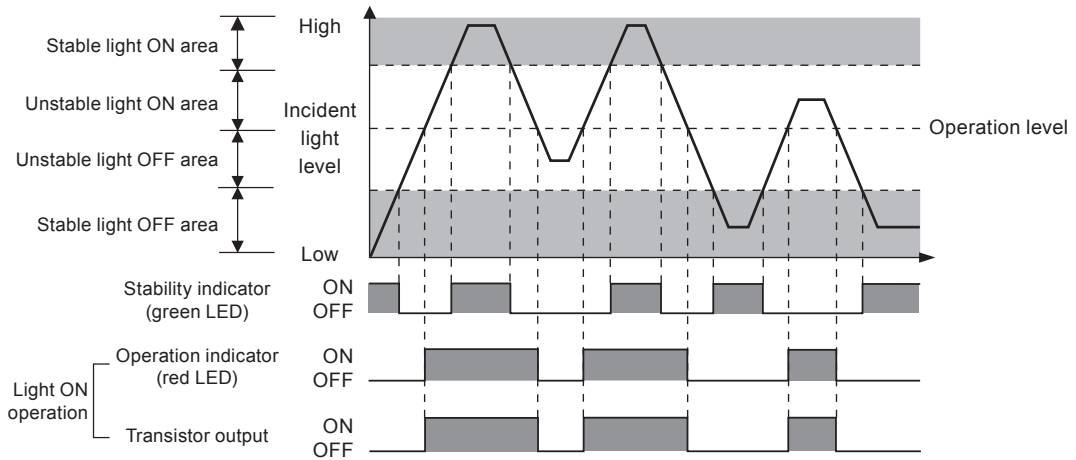

※The waveforms of “Operation indicator” and “Transistor output” are for Light ON operation. They are reversed for Dark ON operation.

■ Mounting and Sensitivity Adjustment

◎ Installation

Use M2 bolts to install this sensor, and keep the tightening torque under 0.3N·m.

※Exercise caution. Do not apply excessive impact to the unit or bend the cable section. The inside unit may be wet.

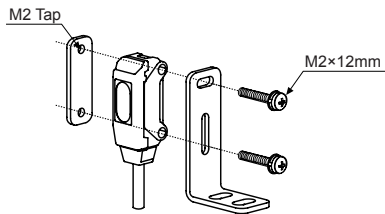

※Cautions during installation of convergent reflective type

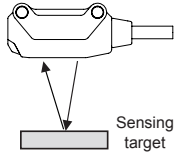
- 1) Make sure that the sensing side of this sensor is parallel to the surface of each object. 
- 2) Make sure to install the sensor after carefully considering the moving direction of the sensing objects. Refer to the illustration below.

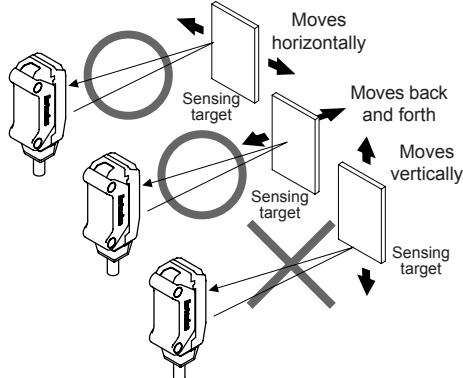

◎ Optical axis adjustment

● Through-beam type

Set the emitter and the receiver facing each other. Adjust the emitter or the receiver up, down, left, right and fix the unit at the center point of where the stability indicator is operating.

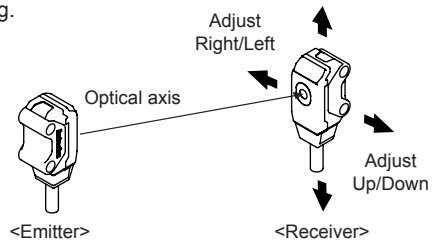

● Retroreflective type

Place the sensor and the reflector (MS-6) or reflective tape facing each other. Adjust the reflector up, down, left, right and fix the reflector at the center position where the stability indicator is operating. Make sure that the sensing side of the sensor is parallel to the surface of the reflector.

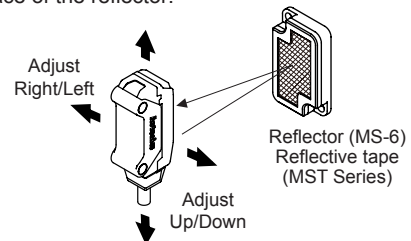

※Please use reflective tape (MST Series) for where a reflector is not installed.

Ultra-compact Amplifier Built-in Type

● Convergent reflective type

Place the sensing target, then adjust the sensor up, down, left, right and fix the sensor at the center position where the stability indicator is operating. Make sure that the sensing side of the sensor is parallel to the surface of each object.

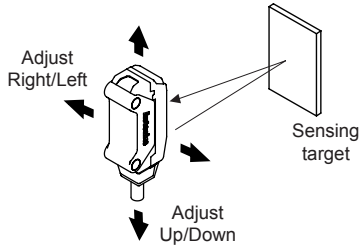

◎ Conditions of min. sensing target and installations (retroreflective type)

When installing the retroreflective photoelectric sensor, be sure to check the moving direction of sensing targets. Please refer to the [Figure 1, 2].

As the [Figure 3], please consist the center between the sensor and the reflector (MS-6) or reflective tape, and check the stable Light ON operations (operation (red) / stability (green) indicators turn ON). Min. sensing target is detected 100mm away from the sensor (example).

[Figure 1]

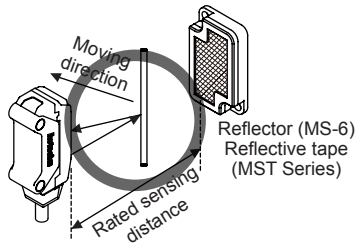

[Figure 2]

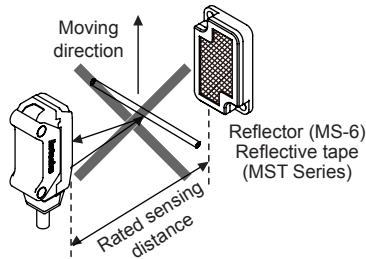

[Figure 3]

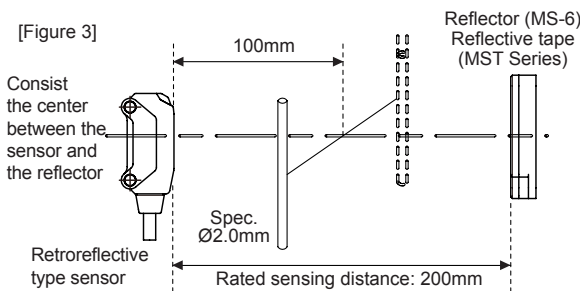

※The size of minimum sensing target will vary by the installation environment of the reflector (MS-6) and the sensing position and material of the sensing target.

■ Accessory (sold separately)

● Slit (model: BTS1M-ST)



● Min. sensing target and max. sensing distance by slit's Ø when attach the slit at an emitter.

Slit Ø	Min. sensing target	Max. sensing distance
Ø1	Opaque materials of Min. Ø1.6	500mm

※This slit is for BTS1M-TDT□□ only.

※4 pieces are packed and sold separately.

※This slit is sticker for attachment, please remove the dirt on lens of photoelectric sensor before using it.

After attach the slit, remove the front protection film.

■ Reflectivity by Reflective Tape Model

MST-50-10 (50×50mm)	95%
MST-100-5 (100×100mm)	100%
MST-200-2 (200×200mm)	100%

※This reflectivity is based on the reflector (MS-6).

※Reflectivity may vary depending on usage environment and installation conditions.

The sensing distance and minimum sensing target size increase as the size of the tape increases. Please check the reflectivity before using reflective tapes.

※For using reflective tape, installation distance should be min. 20mm.

(A)	Photoelectric Sensors
(B)	Fiber Optic Sensors
(C)	Door/Area Sensors
(D)	Proximity Sensors
(E)	Pressure Sensors
(F)	Rotary Encoders
(G)	Connectors/ Connector Cables/ Sensor Distribution Boxes/sockets
(H)	Temperature Controllers
(I)	SSRs / Power Controllers
(J)	Counters
(K)	Timers
(L)	Panel Meters
(M)	Tacho / Speed / Pulse Meters
(N)	Display Units
(O)	Sensor Controllers
(P)	Switching Mode Power Supplies
(Q)	Stepper Motors & Drivers & Controllers
(R)	Graphic/ Logic Panels
(S)	Field Network Devices
(T)	Software