

LCD Display, Digital Fiber Optic Amplifier

■ Features

- Dual-display for light incident level and setting value (BF5 -D)
- Enables to detect the minute object with 1/10,000 high resolution
- Enables to detect with high-speed moving object (response speed 50μs)
- 5 response speeds
 - : ultra fast mode (50μs), high speed mode (150μs), standard mode (500μs), long distance mode (4ms), ultra long distance mode (10ms)
- Anti-saturation setting function prevents malfunction by saturated light
- External input
 - : emitter OFF, remote sensitivity setting, peak reset, output ON/OFF/Keep, Energy saving OFF
- Multiple sensitivity setting modes available
 - : auto tuning (fine-adjusting sensitivity), teaching sensitivity setting (button or external input-auto-tuning, 1-point, 2-point, positioning)



⚠ Please read "Safety Considerations" in operation manual before using.



■ Specifications

Model	NPN open collector output BFX-D1-N	PNP open collector output BFX-D1-P
Light source	Red LED (660nm, modulated)	
Power supply	12-24VDC \pm 10%	
Current consumption	Max. 50mA	
Operation mode	Light ON/Dark ON Selectable	
Control output	NPN or PNP open collector output • Load voltage: max. 24VDC \pm • Load current: max. 100mA • Residual voltage - NPN: max. 1VDC \pm , PNP: max. 3VDC	
Protection circuit	Reverse power polarity protection, output short over current protection circuit, surge protection	
Response time	Ultra Fast: 50μs, fast: 150μs, standard: 500μs, long: 4ms, ultra Long: 10ms	
Display method	7 Segment (PV: red, SV: green) LCD Display, control output indicator (red) LED method	
Display function	Incident light level/SV display [4,000/10,000 resolution], standard / percentage display, high/low peak value display, normal/reversed display	
Sensitivity setting	• Manual sensitivity setting • Teaching sensitivity setting (sensitivity setting by button or external input) : auto-tuning, 1-point, 2-point, positioning	
Timer function	OFF, OFF Delay, ON Delay, One-shot (time setting: 1 to 5000ms)	
External input function	Remote sensitivity setting, peak value reset, emitter OFF, control output setting (Keep/ON/OFF), energy saving OFF (operates applying over 2ms of external input signal)	
Insulation resistance	Over 20MΩ (at 500VDC megger)	
Dielectric strength	1,000VAC 50/60Hz for 1min	
Vibration	1.5 mm amplitude at frequency of 10 to 55Hz (for 1 min) in each X, Y, Z direction for 2 hours	
Shock	500m/s ² (approx. 50G) in each X, Y, Z direction for 3 times	
Environment	Ambient illumination	Sunlight: max. 11,000lx, incandescent lamp: max. 3,000lx (received illumination)
	Ambient temperature	-10 to 50°C, storage: -20 to 70°C
	Ambient humidity	35 to 85%RH, storage: 35 to 85% RH
Protection	IP40 (IEC standard)	
Material	Case: polyketon, cover: polycarbonates	
Fiber optic cable tightening torque	Min. 2kgf	
Accessories	Connector type wire (Ø4mm, 4-wire, 2m / AWG22, core diameter: 0.08mm, number of cores: 60, insulator diameter: Ø1.25mm)	
Approval	CE	
Weight ^{※1}	Approx. 115g (approx. 16g)	

※1: The weight includes packaging. The weight in parenthesis is for unit only.

※The temperature or humidity mentioned in Environment indicates a non freezing or condensation environment.

(A)	Photoelectric Sensors
(B)	Fiber Optic Sensors
(C)	Door/Area Sensors
(D)	Proximity Sensors
(E)	Pressure Sensors
(F)	Rotary Encoders
(G)	Connectors/ Connector Cables/ Sensor Distribution Boxes/Sockets
(H)	Temperature Controllers
(I)	SSRs / Power Controllers
(J)	Counters
(K)	Timers
(L)	Panel Meters
(M)	Tacho / Speed / Pulse Meters
(N)	Display Units
(O)	Sensor Controllers
(P)	Switching Mode Power Supplies
(Q)	Stepper Motors & Drivers & Controllers
(R)	Graphic/ Logic Panels
(S)	Field Network Devices
(T)	Software

BFX Series

Control Output Circuit Diagram and Connections

• NPN open collector output

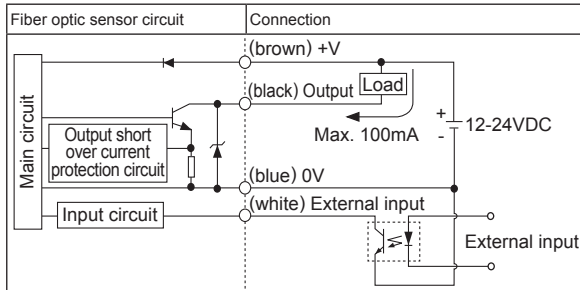

• PNP open collector output

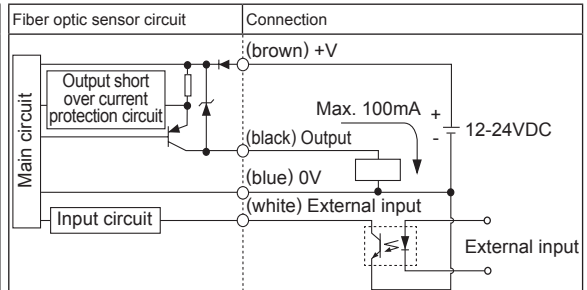

※When using external input function, use photocoupler, external controller, etc. Otherwise, it may result in product damage.

Dimensions

(unit: mm)

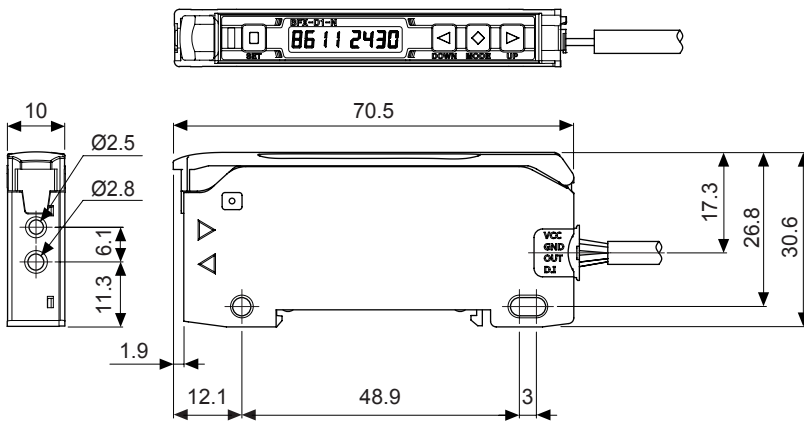

• Accessories

- Connector type wire (length: 2m)

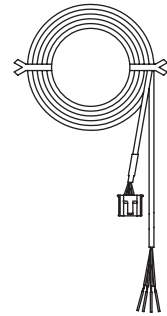

Installations

◎ Amplifier unit mounting

- Installation: Hang up the backside holder on the DIN rail and press the unit toward the DIN rail.
- Removal: Slide the back part of the unit as the ① figure and lift up the unit as the ② figure.

◎ Installing with several units

- After mounting the amplifier unit on DIN rail, attach additional amplifier units adjacently as shown in the arrow.
- This unit does not have mutual interference prevention function. Be sure not to have mutual interference.

※Do not supply the power while connecting / disconnecting amplifier units.

◎ Connector cable attachment and detachment

- Lift up the protective cover to the ① direction and completely lower the lock lever to the direction of to the ② direction to release the lock setting.
- Insert the cable to the ③ direction and adhere between the cable and the inside of the amplifier unit. (Insert depth: receiver part approx. 8mm / emitter part approx. 7mm)
- Place up the lock lever to lock the lock setting to the ④ direction and close the protective cover to the ⑤ direction.

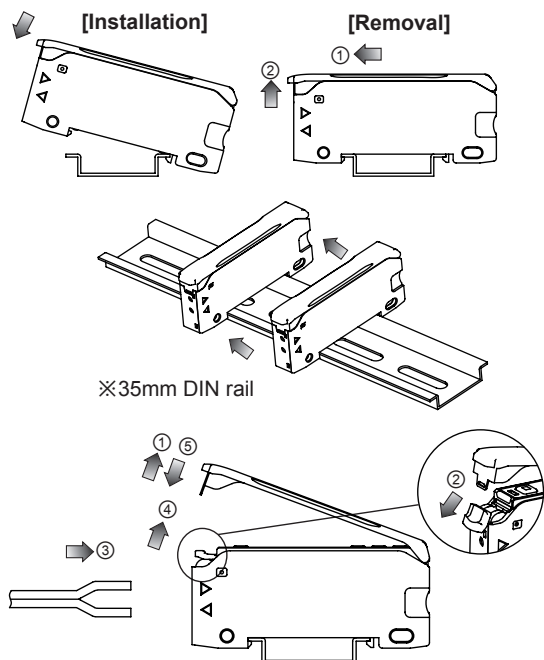

Fiber Optic Amplifier

◎ Insert/Remove connector

- Insert the connector into the amplifier unit until it clicks into the right position.
- Remove the connector by pressing the end part at ① direction and pull it to ② direction.

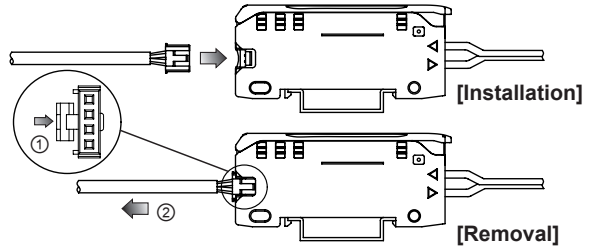

■ Unit Descriptions

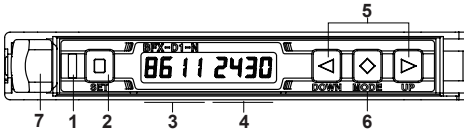

- 1. Control output indicator:** Used to indicate control output provided by comparing SV and actual incident light level.
- 2. (SET) key:** Used to execute each operation and to set sensing sensitivity.
- 3. Measured value (PV) display part**
 - RUN mode: It displays present value (PV) of input incident light.
 - Setting mode: It displays the parameter.
- 4. Set value (SV) display part**
 - RUN mode: It displays the setting value (SV).
 - Setting mode: It displays the setting value of the parameter.
- 5. (MODE) key:** Used to enter SV setting mode, move up/down digit, set sensitivity manually.
- 6. (MODE) key:** Used to enter program mode, RUN mode, move parameters, or save the setting value.
- 7. Lock lever:** Used to connect fiber optic cable.

■ Parameter Setting

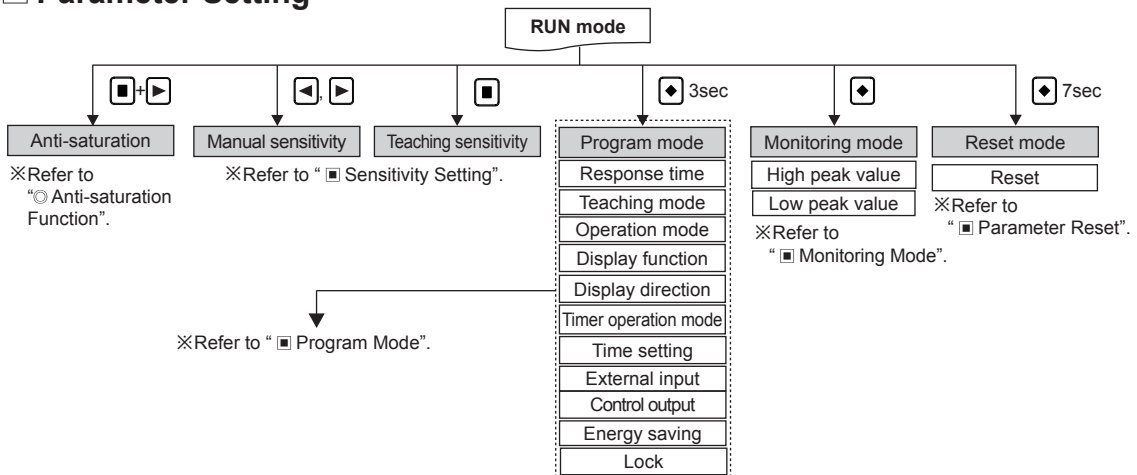

■ Sensitivity Setting

※ You can set sensitivity by manual or teaching (sensitivity setting by button or external input). Execute the proper sensitivity settings for your application.

◎ Manual sensitivity setting (fine-adjusting sensitivity)

- This setting is to set the sensitivity manually.
- Used to fine-adjust sensitivity after the teaching sensitivity setting.
- Incident light level is still displayed on the Measured value (PV) display part during setting.

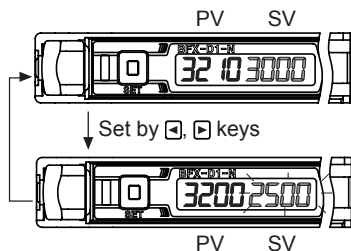

- ① Press the (MODE), (MODE) keys to set the value.
- ② Press the (MODE) key to complete the setting. If there is no key input for 3 sec after completing setting, last set value flashes twice (every 0.5 sec) and automatically saved it and returned to RUN mode.

Set value flashes twice (every 0.5 sec) and it returns to RUN mode.

(A)	Photoelectric Sensors
(B)	Fiber Optic Sensors
(C)	Door/Area Sensors
(D)	Proximity Sensors
(E)	Pressure Sensors
(F)	Rotary Encoders
(G)	Connectors/ Connector Cables/ Sensor Distribution Boxes/Sockets
(H)	Temperature Controllers
(I)	SSRs / Power Controllers
(J)	Counters
(K)	Timers
(L)	Panel Meters
(M)	Tacho / Speed / Pulse Meters
(N)	Display Units
(O)	Sensor Controllers
(P)	Switching Mode Power Supplies
(Q)	Stepper Motors & Drivers & Controllers
(R)	Graphic/ Logic Panels
(S)	Field Network Devices
(T)	Software

BFX Series

⊙ Teaching sensitivity setting (sensitivity setting by button or external input)

- Sensitivity setting by button (■) (SET) key) : Press the ■ (SET) key once in RUN mode and teaching automatically starts. When teaching completes, it returns to RUN mode automatically.
 - Sensitivity setting by external input: Set the sensitivity by external input signal wire not by using the ■ (SET). This is available only when external input [d.i.n] is set as [SEt]. (Refer to “■ Control output circuit diagram and Connections”.)
 - During teaching, the Measured value (PV) display part displays the set teaching mode parameter and the setting value (SV) display part displays progressing status.
 - Before sensitivity setting, set the proper teaching mode (auto-tuning, one-point, two-point, positioning teaching mode) .
- ※Refer to the below for the each teaching sensitivity setting.

1) Auto-tuning teach mode

- ※Suitable when incident level of sensing object is not stable or when sensing fast moving objects.
- ※Auto-tune automatically sets the sensitivity using the average value of the max./min. incident light level within a certain time period.

$$\text{Set value} = \frac{P(\text{Max}) + P(\text{Min})}{2}$$

- Set Teaching mode parameter [SEn5] to *Auto* .

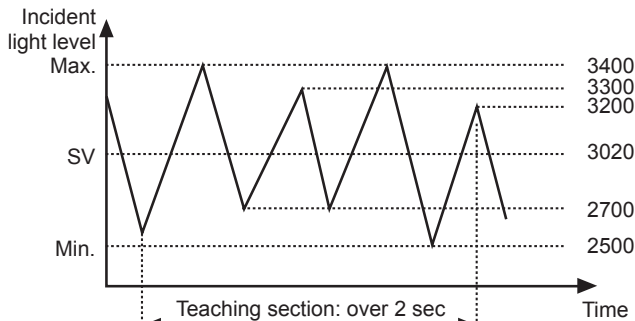

※Press the ■ (SET) key once, and teaching starts automatically.



Flashes twice (every 0.5 sec) and it returns to RUN mode

2) One-point teach mode

- ※One of teaching modes that sets the maximum sensitivity by teaching one sensitivity setting point when setting the SV with no sensing object (reflective) or when setting the SV with incident light level 0 (through-beam) / Suitable for the applications required little effect of dust or background.

- Set Teaching mode parameter [SEn5] to *IPnt* .

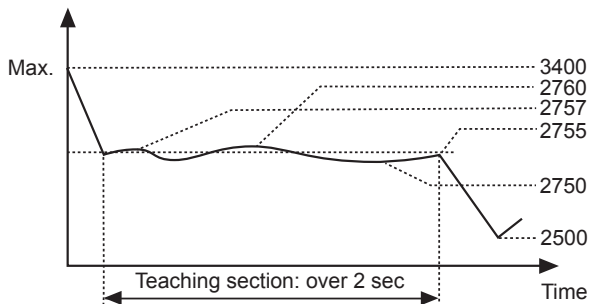

※Press the ■ (SET) key once, and teaching starts automatically.

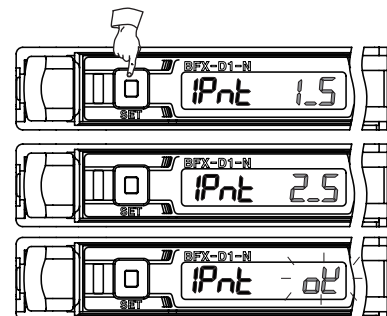

Flashes twice (every 0.5 sec) and it returns to RUN mode

3) Two-point teach mode

※Suitable when incident light level is stable or when sensing object is slow or at stopped position.

※One of teaching modes that sets the sensitivity using the average value of two incident light levels obtained from two point teaching - one point with a sensing object and the other point without a sensing object.

- Set Teaching mode parameter [5En5] to 2Pnt.

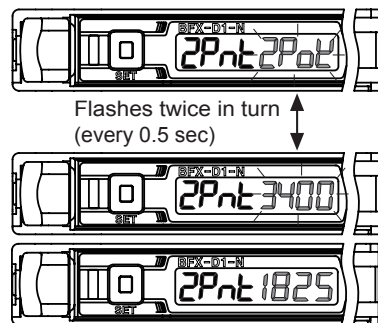
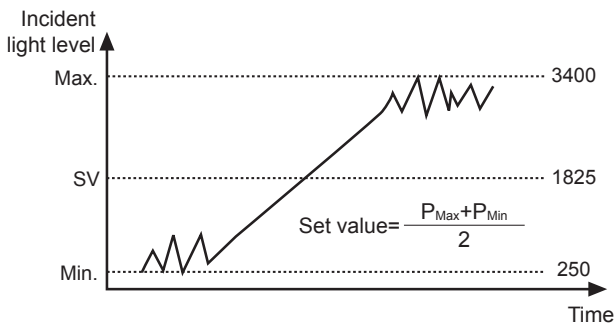
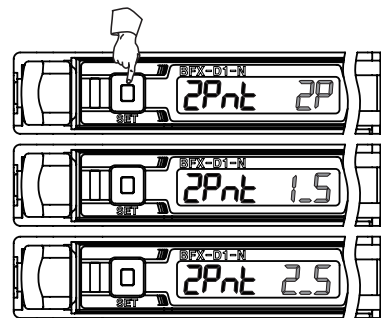
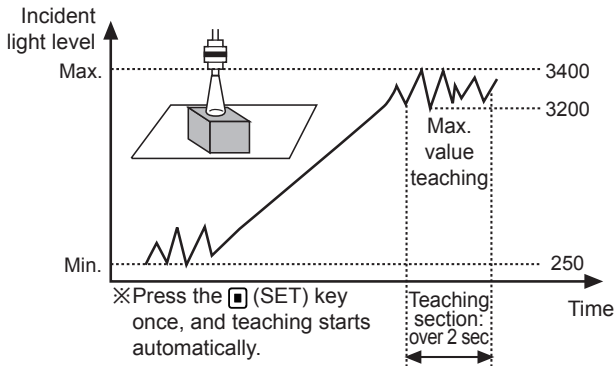
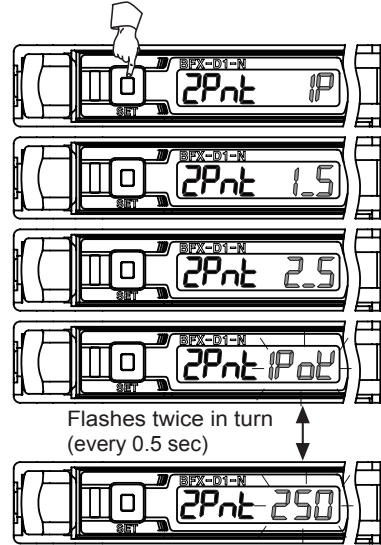
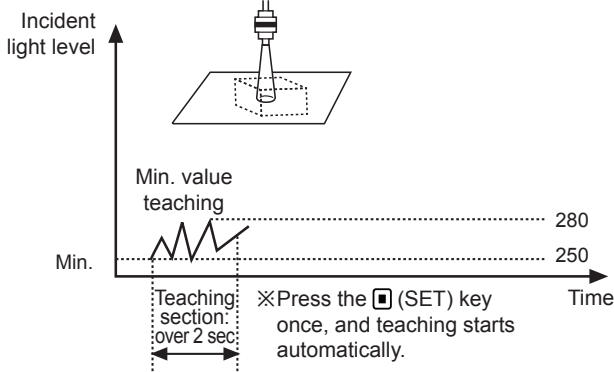

(A) Photoelectric Sensors

(B) Fiber Optic Sensors

(C) Door/Area Sensors

(D) Proximity Sensors

(E) Pressure Sensors

(F) Rotary Encoders

(G) Connectors/ Connector Cables/ Sensor Distribution Boxes/Sockets

(H) Temperature Controllers

(I) SSRs / Power Controllers

(J) Counters

(K) Timers

(L) Panel Meters

(M) Tacho / Speed / Pulse Meters

(N) Display Units

(O) Sensor Controllers

(P) Switching Mode Power Supplies

(Q) Stepper Motors & Drivers & Controllers

(R) Graphic/ Logic Panels

(S) Field Network Devices

(T) Software

BFX Series

4) Positioning teach mode

※One of teaching modes that sets the sensitivity to 90% of max. incident light level when sensing an object with a hole on the surface (Through-beam) or sensing a moving object having curve (Reflective).

- Set teaching mode parameter [SEn5] to P5tn.

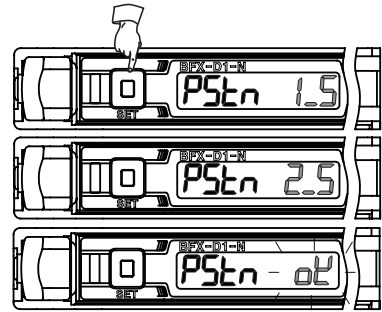
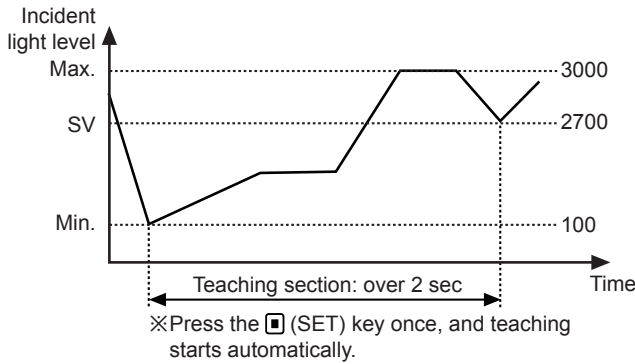

Flashes twice (every 0.5 sec) and it returns to RUN mode

※Set value (SV) range for sensing distance.

Response Time	Teaching when incident light level is 0	Teaching when incident light level is saturated
UF5t / F5t / 5td	Set to 10-digit.	Set to 3980-digit.
L0G / UL0G	Set to 5-digit.	Set to 9980-digit.

■ Error Display

Error code	Cause	Troubleshooting
Err	In case overcurrent inflow occurs into the output circuit.	Remove the overcurrent due to the overload.

■ Program Mode

- When entering into program mode, the parameter turns ON at the Measured value (PV) display part and the setting value flashes every 0.5 sec at the setting value (SV) display part. Use the [], [] keys to set each setting value.
- Press the [] (MODE) key one time after setting each parameter to save the setting and enter into next mode.
- If the lock is set, unlock the key before setting parameters.

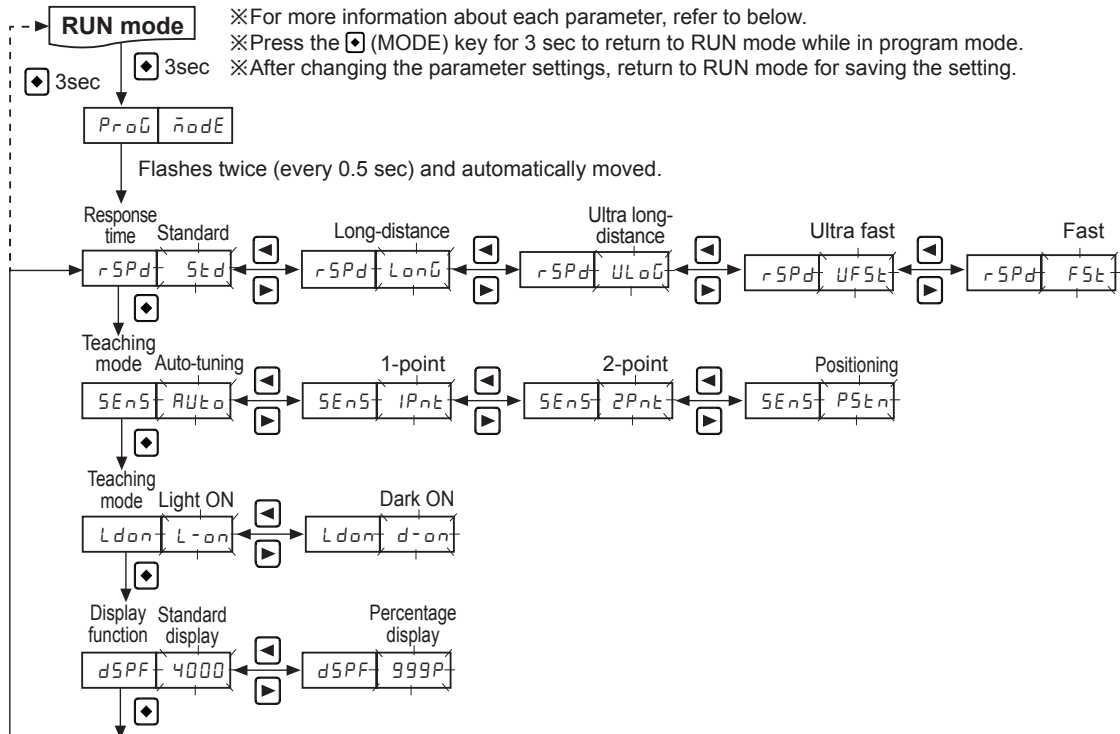

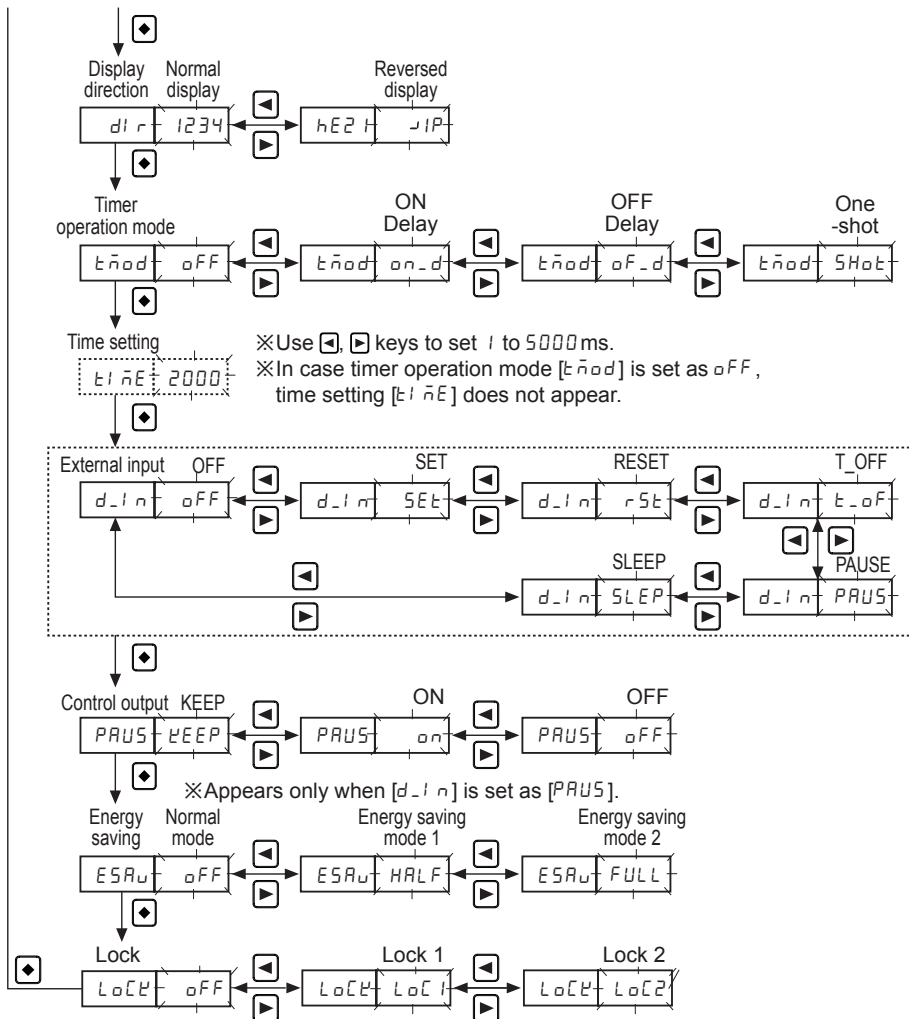

(A)	Photoelectric Sensors
(B)	Fiber Optic Sensors
(C)	Door/Area Sensors
(D)	Proximity Sensors
(E)	Pressure Sensors
(F)	Rotary Encoders
(G)	Connectors/ Connector Cables/ Sensor Distribution Boxes/Sockets
(H)	Temperature Controllers
(I)	SSRs / Power Controllers
(J)	Counters
(K)	Timers
(L)	Panel Meters
(M)	Tacho / Speed / Pulse Meters
(N)	Display Units
(O)	Sensor Controllers
(P)	Switching Mode Power Supplies
(Q)	Stepper Motors & Drivers & Controllers
(R)	Graphic/ Logic Panels
(S)	Field Network Devices
(T)	Software

■ Program Mode Function

◎ Response time [rSPd]

This function is to set the response time of control output.

- Ultra fast [UF5t]: 50μs
- Fast [F5t]: 150μs
- Standard [5td]: 500μs
- Long distance [LONt]: 4ms
- Ultra long distance [ULOG]: 10ms

◎ Operation mode [Ldon]

This function is to set Light ON - control output is ON when incident light level is higher than setting value and Dark ON - control output is ON when incident light level is lower than setting value.

◎ Display [dSPF]

This function is to select display mode for incident light level on the PV display part.

- : standard display (4000) / Percentage display (999P)
- Display range of standard display: 0 to 4000 (0 to 9999, in case of long distance mode)
- Display range of percentage display: 0P to 999P (decimal point is not displayed)

◎ Display direction [dir]

This function is to reverse the display direction to suit the unit installation location.

: Normal display / Reversed display selectable.

※ Reversed display is upside-down (180°) display of normal display.

BFX Series

⊙ Timer [Timer operation mode: $t_{\bar{n}od}$, Time setting: $t_{i\bar{n}E}$]

This function is for when the response speed of external device is too slow or control output time is short by small target sensing.

- Timer OFF [oFF]: Do not use timer function.
- ON Delay [o_n-d]: Control output time from OFF to ON is delayed during the setting time.
- OFF Delay [$oF-d$]: Control output time from ON to OFF is delayed during the setting time.
- One-shot [$SHot$]: Control output turns ON or OFF within the setting time.
- Time setting [$t_{i\bar{n}E}$]: 1 to 5000ms
- Timing chart

[T: setting time]

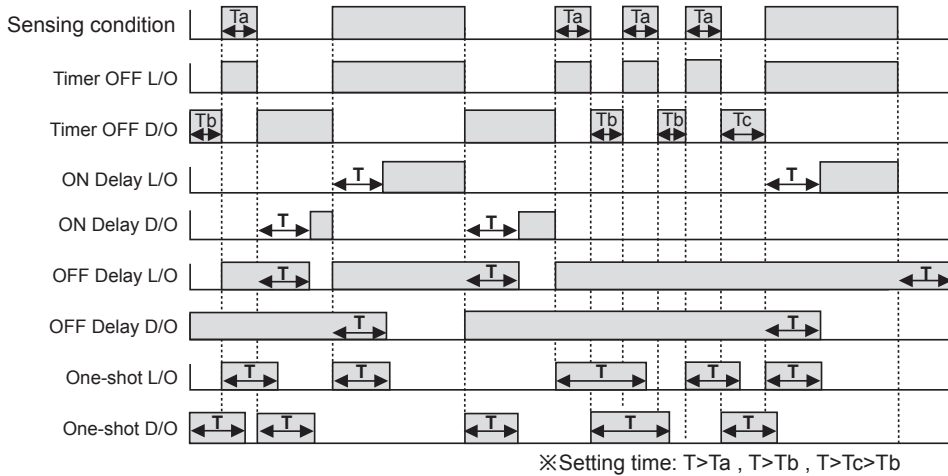

⊙ External input [$d_{-i\bar{n}}$]

If button operation is difficult, external input is available to execute the dedicated operation.

- OFF [oFF]: Do not use external input function.
- SET [SEt]: External input is used for sensitivity setting, depending on the teaching mode parameter [$SEn5$].
- RESET [$rSEt$]: External input is used for initializing high peak/low peak.
- T_OFF [t_{-oF}]: During external input, emitter turns OFF.
- PAUSE [$PAUS$]: External input is used for setting control output mode between Keep/ON/OFF.
- SLEEP [SLP]: External input is used for turning OFF the energy saving [ESR_u] mode.

⊙ Control output setting [$PAUS$]

External input is used for setting control output mode between Keep [$KEEP$]/ON [o_n]/OFF [oFF]. Only when inputting over the response time (2ms), it is regarded as external input and control output is changed as setting.

(This function is activated only when external input parameter [$d_{-i\bar{n}}$] is set to [$PAUS$].)

- Keep [$KEEP$]: Control output status at the inputting moment of external input (a) is maintained while external input is ON.

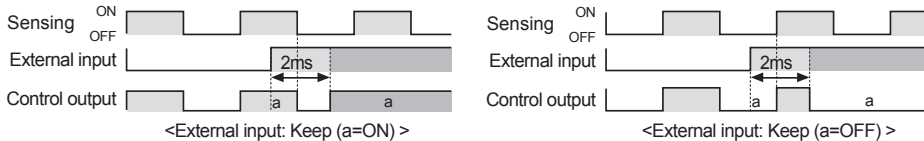

- ON [o_n]/OFF [oFF]: Control output is ON/OFF while external input is ON.

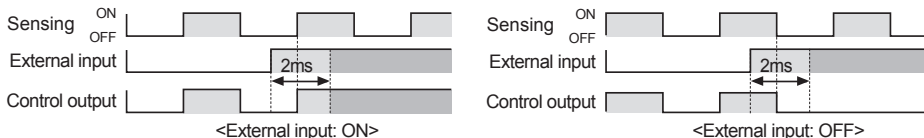

⊙ Energy saving [ESR_u]

This function is to save unit's power consumption by reducing power supplying to display parts in case of no setting input within 60 sec.

Type	Control output indicator	Measured value (PV) display part	Set value (SV) display part
Normal mode [oFF]	☀	☀	☀
Energy saving mode 1 [$HRLF$]	☀	☀	●
Energy saving mode 2 [$FULL$]	☀	●	●

☀: ON
●: OFF

Ⓞ Lock [L o C k]

Two types of key lock setting available in order to prevent SV changes due to careless.

Parameter	oFF	L o C 1	L o C 2
Sensitivity setting	●	◐	◑
Program mode	●	◐	○
Parameter reset	●	○	○
Anti-saturation	●	○	○
External input	●	○	○

●: available to check/set
 ◐: available to check/ unavailable to set
 ○: unavailable to check/set

● In case of L o C 2, it is required to set to lock first to enter into parameter mode.

Ⓞ Anti-saturation

- When the sensing target comes too close and it is saturation status, this function corrects the optimize status.
- Press the **[SET] + []** keys one time and anti-saturation function operates automatically. There are max. 10 levels.
- Press the **[SET] + []** keys one time again and anti-saturation function is cleared.
- During anti-saturation, the setting value (SV) display part displays current level.
- When response time mode is ultra fast[U F 5 t], fast[F 5 t], standard[S t d], and incident light is over than 2000, the setting is complete. When the mode is long distance[L o n g], ultra long distance[U L o g], and incident light is over than 5000, the setting is complete. After completing the setting, it returns to RUN mode automatically.

※ This function does not execute when present incident is lower than the determined value.

(U F 5 t, F 5 t, S t d: 2000, L o n g, U L o g: 5000)

※ When anti-saturation function is set, control output operation may be changed.

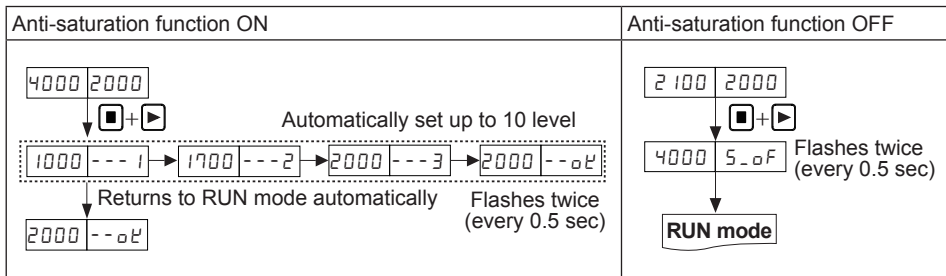

■ Monitoring Mode

This function is to monitor high/low peak value of incident light level. The monitored high/low peak value can be reset.

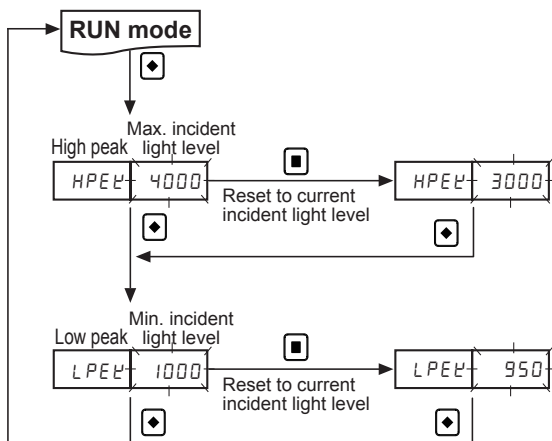

- ① Press the **[MODE]** key for a sec to monitor max/min incident light level.
- ② Press the **[SET]** key to initialize max/min value to current incident light level during monitoring.
- ③ Press the **[MODE]** key to return to RUN mode.

※ When lock is set as L o C 2 and max./min. value is checked, it is not reset.

(A)	Photoelectric Sensors
(B)	Fiber Optic Sensors
(C)	Door/Area Sensors
(D)	Proximity Sensors
(E)	Pressure Sensors
(F)	Rotary Encoders
(G)	Connectors/ Connector Cables/ Sensor Distribution Boxes/Sockets
(H)	Temperature Controllers
(I)	SSRs / Power Controllers
(J)	Counters
(K)	Timers
(L)	Panel Meters
(M)	Tacho / Speed / Pulse Meters
(N)	Display Units
(O)	Sensor Controllers
(P)	Switching Mode Power Supplies
(Q)	Stepper Motors & Drivers & Controllers
(R)	Graphic/ Logic Panels
(S)	Field Network Devices
(T)	Software

Parameter Reset

- This function is to initialize all parameters in memory to default value in case the possibility of mis-setting or mis-operation.
- Set lock function [L o C k] to o F F to execute parameter initialization.
- High peak value [H P E L] and low peak value [L P E L] is not initialized.

Parameter reset flow

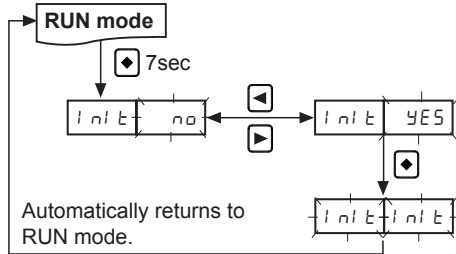

- ① Press the **MODE** key for 7 sec in RUN mode. [i n i t] parameter turns ON on the Measured value (PV) display part and n o flashes every 0.5 sec on the setting value (SV) display part.
- ② Press the **MODE** key once again to return to RUN mode not to execute the initialization.
- ③ Select y e s using **←**, **→** keys and press the **MODE** key. i n i t flashes twice on both the Measured value (PV) and Set value (SV) display parts.
- ④ When parameter initialization is completed, it is automatically returned to RUN mode.

Factory default

Parameter	Default	Parameter	Default	Parameter	Default	Parameter	Default	Parameter	Default
r S P d	S t d	S E n S	R U t o	L d o n	L - o n	d S P F	4 0 0 0	d i r	1 2 3 4
t n o d	o F F	d _ i n	o F F	E S R u	o F F	L o C k	o F F	—	—

SV: 2000