

Rating	20A 12V DC
Contact Resistance	50m ohm Max.
Insulation Resistance	DC 500V 100M ohm Min.
Dielectric Strength	AC 1500V 1 minute
Operation Temperature	-25°C~85°C
Switch Function	4P DPST ON-OFF(Led Dependent)

Mounting Hole

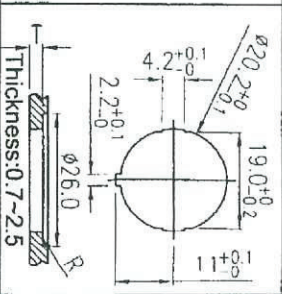

Material:
 Frame: Black, Nylon 66
 Actuator: Red, PC
 Printed: None

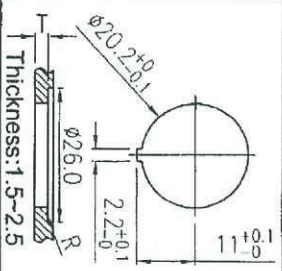
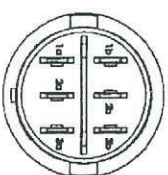
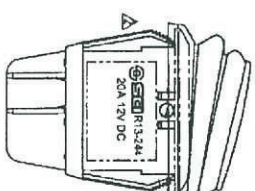
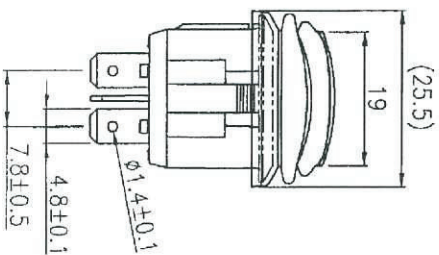
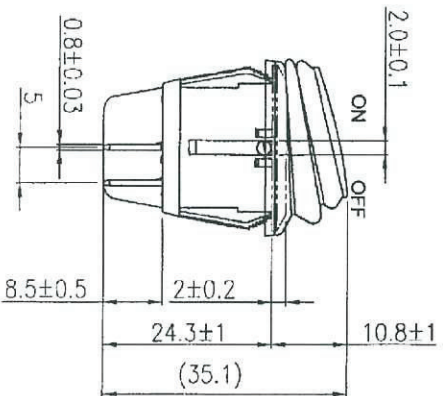
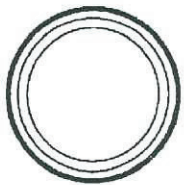
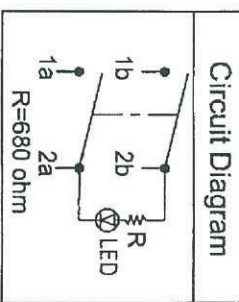

Tolerances ±0.3 Unless Otherwise Specified

9/20/12	張東	更新本體印刷，加SCI LOGO.						
6/27/07	曹焱芳	R13-244A8系列只通過UL，本體取消ENEC,增加T85，重新出圖.						
Date	Name	Description		No.				
Drawn	Checked	Approved	SCI BOM No.	1823924	Model Name	ROCKER SWITCH		
張東	曹焱芳	曹焱芳	Customer No.		Model No.	R13-244B8-02	Rev.	
9/20/12	9/28/12	9/28/12	Unit	mm	Shin Chin Industrial Co., Ltd.		2	