

Rating	20A 12V DC
Contact Resistance	50m ohm Max.
Insulation Resistance	DC 500V 100M ohm Min.
Dielectric Strength	AC 1500V 1 minute
Operation Temperature	-25°C-85°C
Switch Function	4P DPST ON-OFF(Illuminated)

Mounting Hole

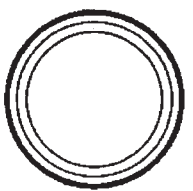

Material:
Frame: Black, Nylon 66
Actuator: Yellow, PC
Printed: None

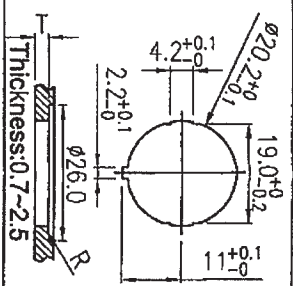
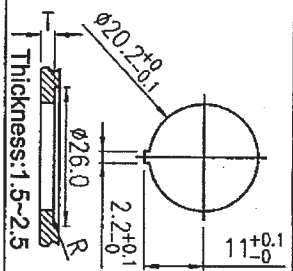
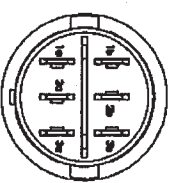
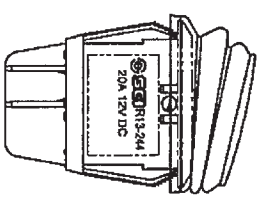
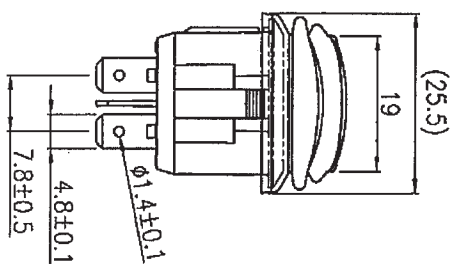
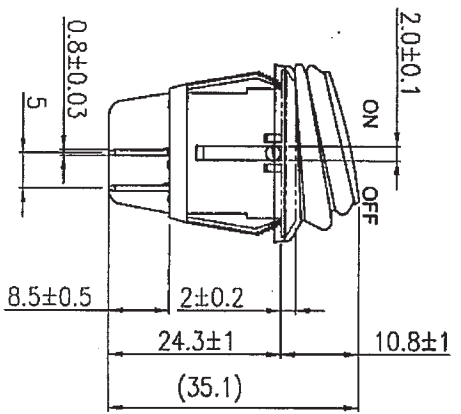
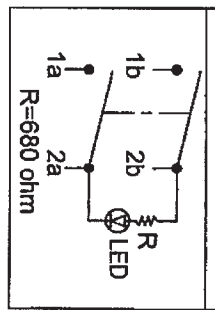

Tolerances ±0.3 Unless Otherwise Specified

Date	Name	Description		No.		
Drawn	Checked	Approved	SCI BOM No	1824172	Model Name	ROCKER SWITCH
張東	Boile	Simons	Customer No		Model No.	R13-244B8-02
9/8/12	9/8-12-1	9/10-12	Unit	mm	Shin Chin Industrial Co., Ltd.	
					Rev.	0