





Rating	16A 12VDC	  	Mounting Hole		Circuit Diagram	
Contact Resistance	50m ohm Max.					
Insulation Resistance	DC 500V 100M ohm Min.					
Dielectric Strength	AC 1000V 1 minute					
Operation Temperature	-25°C~85°C					
Switch Function	3P SPST ON-OFF(LED dependent)		Thickness	X	Y	
			0.75...1.5	19.4-0.1	13+0.1	
			1.5...2.5	19.8-0.1	13+0.1	



Material:  
 Frame: Nylon 66 (94-V2), Black  
 Actuator: PC clear (94-V2), Red  
 Waterproof Rubber: Silicone, Black  
 Terminals: Silver plated, Copper alloy  
 Hot stamping: None  
 Waterproof: IP65  
 LED: Red

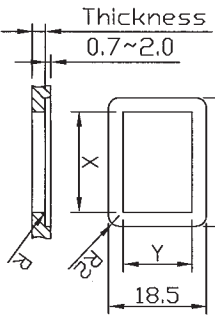
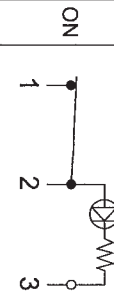
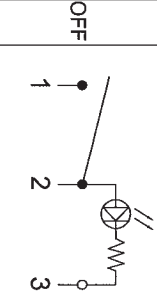
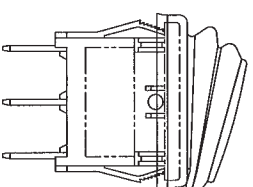
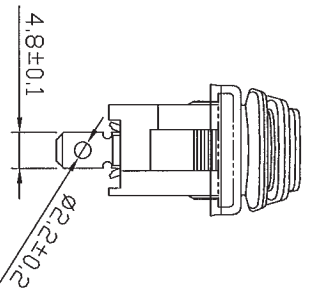
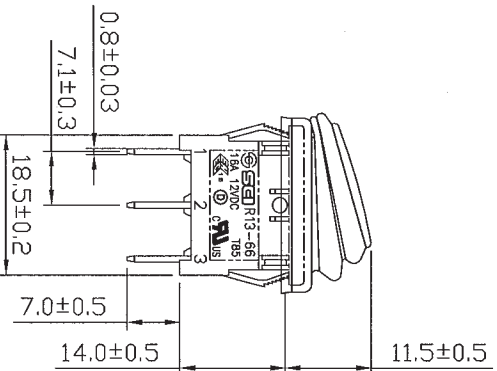
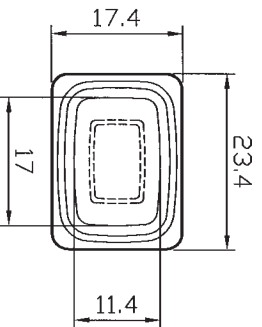
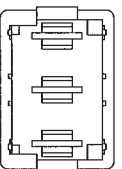

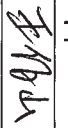
C61R131R13-66B8-02

Date	Name	Description			NO
Drawn	Checked	Approved	SCI BOM NO.	Model Name	ROCKER SWITCH
曹盈芳			1825617	Model No.	R13-66B8-02
04/02/13		4/2/13	Unit	mm	Rev. 0
					Shin Chin Industrial Co., Ltd.