

**3 Phase Control Relay / Relais de contrôle 3 phases / 3-Phasen-Steuerrelais / Relé de control trifásico**  
Relè di controllo a tre fasi / 3 相控制继电器

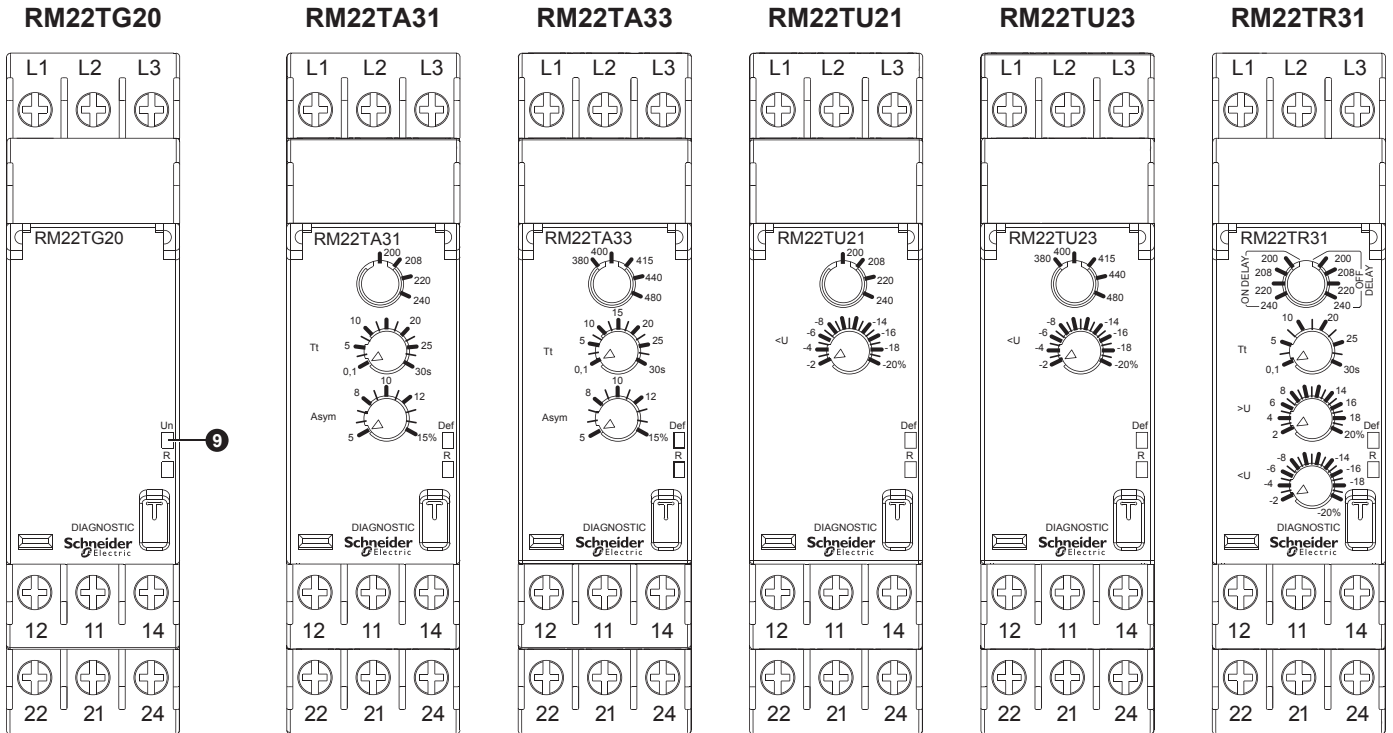

**RM22TR33**

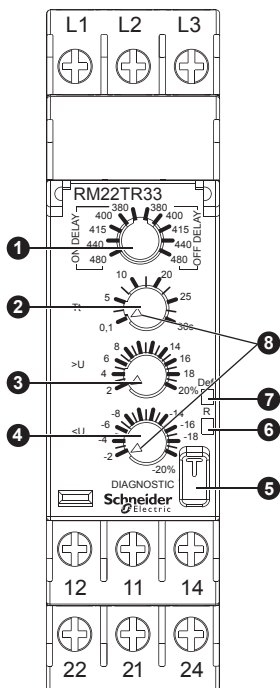

- en**
- 1 Voltage range / Of-Off delay selector switch
  - 2 Time delay adjustment potentiometer Tt
  - 3 Overvoltage setting potentiometer. >U
  - 4 Undervoltage setting potentiometer. <U
  - 5 Diagnostic button
  - 6 Relay output status. (yellow) LED. R
  - 7 Fault detection status. (yellow). Def
  - 8 Dial Pointer / Power Supply indication (green) LED
  - 9 Power status LED (green) Un

- fr**
- 1 Plage de tension / Sélecteur d'activation et de désactivation du délai
  - 2 Potentiomètre d'ajustement de la temporisation Tt
  - 3 Potentiomètre de réglage de la surtension. >U
  - 4 Potentiomètre de réglage de la sous-tension. <U
  - 5 Bouton de diagnostic
  - 6 Etat de sortie relais. Voyant (jaune). R
  - 7 Etat de détection de défaut. Voyant (jaune). Def
  - 8 Voyant d'indicateur Pointeur du cadran / Alimentation (vert)
  - 9 Voyant d'état de l'alimentation (vert). Un

- de**
- 1 Wahlschalter für Spannungsbereich und Ansprech-/Rückfallverzögerung (ON/OFF Delay)
  - 2 Potentiometer zur Einstellung der Verzögerungszeit (Tt)
  - 3 Potentiometer zur Überspannungseinstellung (>U)
  - 4 Potentiometer zur Unterspannungseinstellung (<U)
  - 5 Diagnosetaste
  - 6 Status-LED (gelb) für Relaisausgang (R)
  - 7 Status-LED (gelb) für Fehlererkennung (Def)
  - 8 Skalenzeiger / LED (grün) der Spannungsversorgung
  - 9 Betriebsstatus-LED (grün) (Un)

- es**
- 1 Rango de tensión/Selector de retardo al cierre y a la apertura
  - 2 Potenciómetro de ajuste de temporización Tt
  - 3 Potenciómetro de ajuste de sobretensión. >U
  - 4 Potenciómetro de ajuste de infratensión. <U
  - 5 Botón de diagnóstico
  - 6 LED (amarillo) de estado de salida de relé. R
  - 7 Estado de detección de fallos (amarillo). Def
  - 8 Puntero del marcador/Indicador LED (verde) de la fuente de alimentación
  - 9 LED de estado de alimentación (verde). Un

- it**
- 1 Range della tensione/selettore ritardo On-Off
  - 2 Potenziometro regolazione ritardo Tt
  - 3 Potenziometro impostazione sovratensione. >U
  - 4 Potenziometro impostazione tensione insufficiente. <U
  - 5 Pulsante diagnostica
  - 6 LED stato uscita relè (giallo). R
  - 7 Stato rilevamento guasti. (giallo) Def
  - 8 Indicatore/LED alimentazione (verde)
  - 9 LED stato potenza (verde) Un

- zh**
- 1 电压范围 / 启闭延迟选择开关
  - 2 时间延迟调整电位计 Tt
  - 3 过压设置电位计。>U
  - 4 欠压设置电位计。<U
  - 5 诊断按钮
  - 6 继电器输出状态。(黄色) LED. R
  - 7 故障检测状态。(黄色)。R
  - 8 表盘指针 / 电源指示 (绿色) LED
  - 9 电源状态 LED (绿色) Un

# Voltage Control Relay / Relais de contrôle de tension / Spannungssteuerrelais / Relé de control de tensión / Relè di controllo tensione / 电压控制继电器

RM22UA21MR

RM22UA22MR

RM22UA23MR

RM22UA31MR

RM22UA32MR

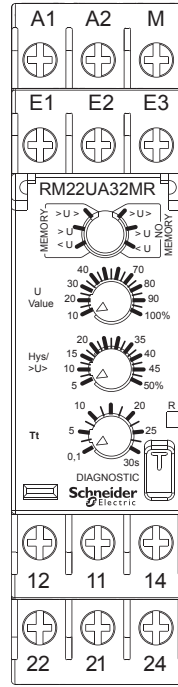
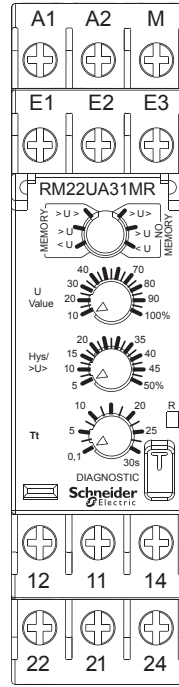
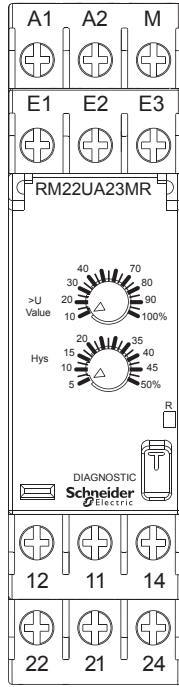
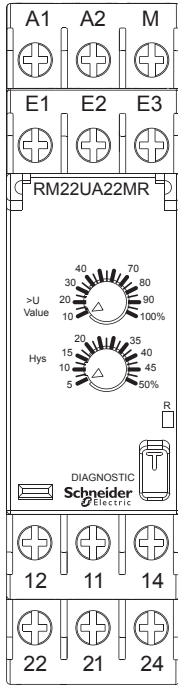
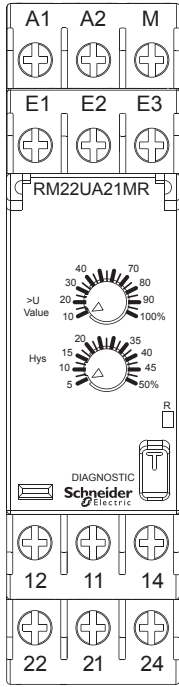

RM22UA33MR

RM22UA33MT

RM22UB34

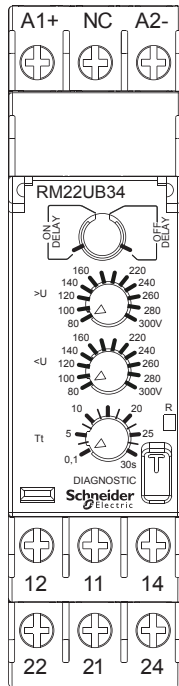
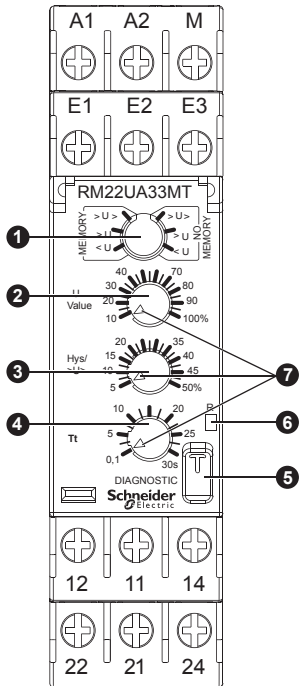
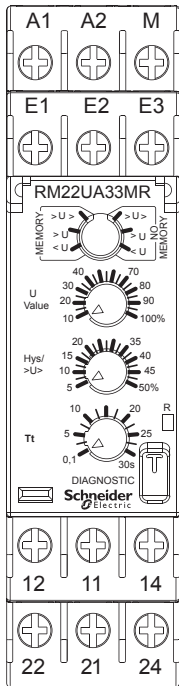

- en**
- 1 Configuration: selection of operating mode <U / >U / >U>, (with or without memory) Memory – No Memory
  - 2 Voltage threshold setting potentiometer. U Value
  - 3 Hysteresis / Window mode >U> adjustment potentiometer
  - 4 Time delay adjustment potentiometer Tt
  - 5 Diagnostic button
  - 6 Relay output status. (yellow) LED. R
  - 7 Dial Pointer / Power Supply indication (green) LED

- fr**
- 1 Configuration : sélection du mode de fonctionnement <U / >U / >U>, (avec ou sans mémoire) Memory – No Memory
  - 2 Potentiomètre de réglage du seuil de tension. Valeur U
  - 3 Potentiomètre de réglage du mode Hystérésis / Fenêtre >U>
  - 4 Potentiomètre de réglage de la temporisation Tt
  - 5 Bouton de diagnostic
  - 6 Etat de sortie relas. Voyant (jaune). R
  - 7 Voyant d'indicateur Pointeur du cadran / Alimentation (vert)

- de**
- 1 Konfiguration: Auswahl der Betriebsart <U / >U / >U>, Mit oder ohne Speicher (Memory – No Memory)
  - 2 Potentiometer zur Einstellung des Spannungsgrenzwerts (U Value)
  - 3 Potentiometer zur Einstellung des Hysterese-/Fenstermodus (Hys./>U>)
  - 4 Potentiometer zur Einstellung der Verzögerungszeit (Tt)
  - 5 Diagnosetaste
  - 6 Status-LED (gelb) für Relaisausgang (R)
  - 7 Skalenzeiger / LED (grün) der Spannungsversorgung

- es**
- 1 Configuración: selección de la modalidad de funcionamiento <U / >U / >U>, (con o sin memoria) MEMORY – NO MEMORY
  - 2 Potenciómetro de ajuste del umbral de tensión. U Value
  - 3 Potenciómetro de ajuste de histéresis/ modalidad de ventana >U>
  - 4 Potenciómetro de ajuste de temporización Tt
  - 5 Botón de diagnóstico
  - 6 LED (amarillo) de estado de salida de relé. R
  - 7 Puntero del marcador/Indicador LED (verde) de la fuente de alimentación

- it**
- 1 Configurazione: selezione modalità di funzionamento <U / >U / >U>, (con o senza memoria) Memoria - No memoria
  - 2 Potenziometeor impostazione soglia tensione. Valore U
  - 3 Isteresi / Modalità finestra >U> potenziometro regolazione
  - 4 Potenziometro regolazione ritardo Tt
  - 5 Pulsante diagnostica
  - 6 LED stato uscita relè (giallo). R
  - 7 Indicatore/LED alimentazione (verde)

- zh**
- 1 配置: 选择 <U / >U / >U> 工作模式, (有或无内存) 内存 - 无内存
  - 2 电压阈值设置电位计。U 值
  - 3 迟滞 / 窗口模式 >U> 调整电位计
  - 4 时间延迟调整电位计 Tt
  - 5 诊断按钮
  - 6 继电器输出状态。(黄色) LED。Tt
  - 7 表盘指针 / 电源指示 (绿色) LED

# Current Control Relay / Relais de contrôle d'intensité / Stromsteuerrelais / Relé de control de corriente Relè di controllo corrente / 电流控制继电器

**RM22JA21MR**

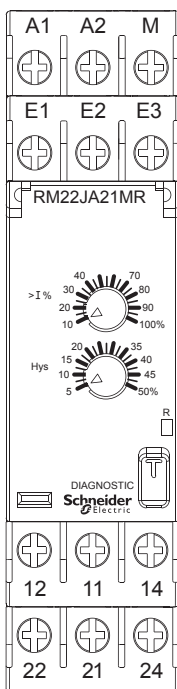

**RM22JA31MR**

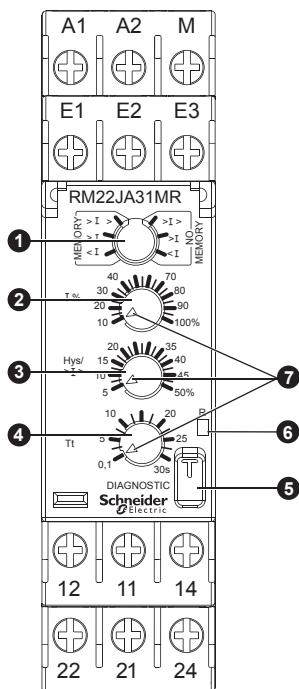

**RM35JA32MR**

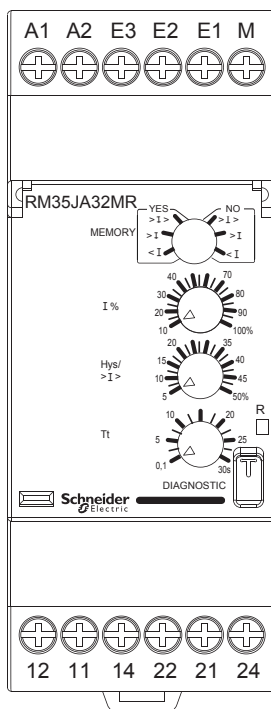

**RM35JA32MT**

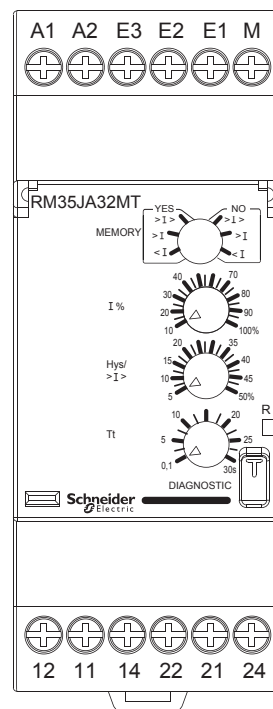

- en**
- 1 Configuration: selection of operating mode <I / >I / >I>, (with or without memory) Memory – No Memory
  - 2 Current threshold setting potentiometer. I %
  - 3 Hysteresis / Window mode >I> adjustment potentiometer
  - 4 Time delay adjustment potentiometer Tt
  - 5 Diagnostic button
  - 6 Relay output status. (yellow) LED. R
  - 7 Dial Pointer / Power Supply indication (green) LED

- fr**
- 1 Configuration : sélection du mode de fonctionnement <I / >I / >I>, (avec ou sans mémoire) Memory – No Memory
  - 2 Potentiomètre de réglage du seuil de l'intensité. I %
  - 3 Potentiomètre de réglage du mode Hystérésis / Fenêtre >I>
  - 4 Potentiomètre de réglage de la temporisation Tt
  - 5 Bouton de diagnostic
  - 6 Etat de sortie relais. Voyant (jaune). R
  - 7 Voyant d'indicateur Pointeur du cadran / Alimentation (vert)

- de**
- 1 Konfiguration: Auswahl der Betriebsart <I / >I / >I>, Mit oder ohne Speicher (Memory – No Memory)
  - 2 Potentiometer zur Einstellung des Stromgrenzwerts (I %)
  - 3 Potentiometer zur Einstellung des Hysterese-/Fenstermodus (Hys./>I>)
  - 4 Potentiometer zur Einstellung der Verzögerungszeit (Tt)
  - 5 Diagnosetaste
  - 6 Status-LED (gelb) für Relaisausgang (R)
  - 7 Skalenzeiger / LED (grün) der Spannungsversorgung

- es**
- 1 Configuración: selección de la modalidad de funcionamiento <I / >I / >I>, (con o sin memoria) MEMORY – NO MEMORY
  - 2 Potenciómetro de ajuste del umbral de corriente. I %
  - 3 Potenciómetro de ajuste de histeresis/ modalidad de ventana >I>
  - 4 Potenciómetro de ajuste de temporización Tt
  - 5 Botón de diagnóstico
  - 6 LED (amarillo) de estado de salida de relé. R
  - 7 Puntero del marcador/Indicador LED (verde) de la fuente de alimentación

- it**
- 1 Configurazione: selezione modalità di funzionamento <I / >I / >I>, (con o senza memoria) Memoria - Senza memoria
  - 2 Potenziometro impostazione soglia corrente. I %
  - 3 Isteresi / Modalità finestra >I> potenziometro regolazione
  - 4 Potenziometro regolazione ritardo Tt
  - 5 Pulsante diagnostica
  - 6 LED stato uscita relè (giallo). R
  - 7 Indicatore/LED alimentazione (verde)

- zh**
- 1 配置: 选择 <I / >I / >I> 工作模式, (有或无内存) 内存 - 无内存
  - 2 电流阈值设置电位计. I %
  - 3 迟滞 / 窗口模式 >I> 调整电位计
  - 4 时间延迟调整电位计 Tt
  - 5 诊断按钮
  - 6 继电器输出状态. (黄色) LED. R
  - 7 表盘指针 / 电源指示 (绿色) LED

# Liquid Control Relay / Relais de contrôle du liquide / Kontrollrelais für Flüssigkeiten Relé de control de líquido / Relè di controllo liquidi / 液体控制继电器

RM22LG11MR

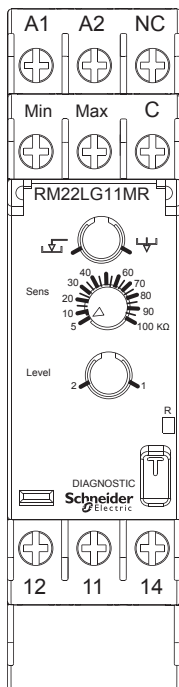

RM22LG11MT

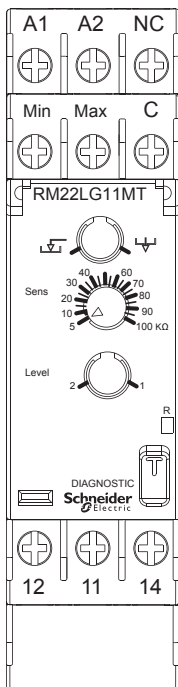

RM22LA32MR

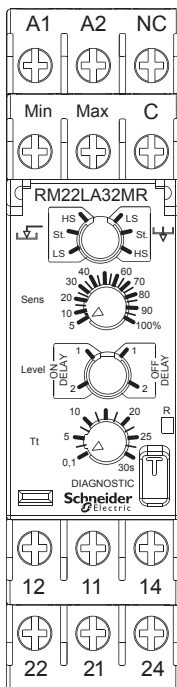

RM22LA32MT

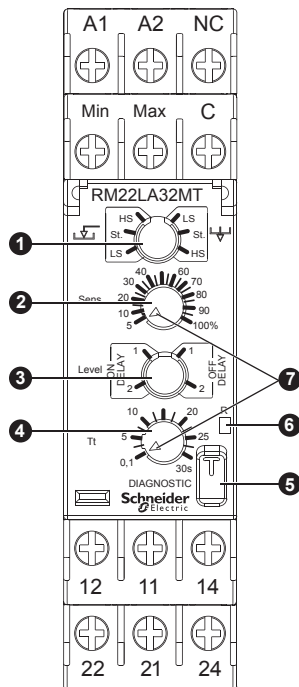

- en** **1** Configuration: selection of the operating mode and the sensitivity range. LS / St / HS  
**2** Sensitivity control potentiometer (%)  
**3** 'Number of levels' selector.  
**4** Time delay control potentiometer. Tt  
**5** Diagnostic Button  
**6** Relay output status (yellow) LED. R  
**7** Dial Pointer / Power Supply indication (green) LED

- fr** **1** Configuration : sélection du mode de fonctionnement et plage de sensibilité. LS / St / HS  
**2** Potentiomètre de contrôle de la sensibilité (%)  
**3** Sélecteur du nombre de niveaux  
**4** Potentiomètre de contrôle de la temporisation. Tt  
**5** Bouton de diagnostic  
**6** Voyant de l'état de sortie relais (jaune). R  
**7** Voyant d'indicateur Pointeur du cadran / Alimentation (vert)

- de** **1** Konfiguration: Auswahl der Betriebsart und des Empfindlichkeitsbereichs (LS / St / HS)  
**2** Potentiometer für die Empfindlichkeitseinstellung  
**3** Wahlschalter für die Pegelanzahl (Level)  
**4** Potentiometer zur Einstellung der Verzögerungszeit (Tt)  
**5** Diagnosetaste  
**6** Status-LED (gelb) für Relaisausgang (R)  
**7** Skalenzeiger / LED der Spannungsversorgung (grün)

- es** **1** Configuración: selección de la modalidad de funcionamiento y del rango de sensibilidad. LS / St. / HS  
**2** Potenciómetro de control de sensibilidad (%)  
**3** Selector de 'Número de niveles'.  
**4** Potenciómetro de control de temporización. Tt  
**5** Botón de diagnóstico  
**6** LED (amarillo) de estado de salida de relé. R  
**7** Puntero del marcador/Indicador LED (verde) de la fuente de alimentación

- it** **1** Configurazione: selezione della modalità di funzionamento e del range di sensibilità. LS / St / HS  
**2** Potenziometro controllo sensibilità (%)  
**3** Selettore 'numero di livelli'.  
**4** Potenziometro controllo ritardo tempo. Tt  
**5** Pulsante diagnostica  
**6** LED stato uscita relè (giallo). R  
**7** Indicatore/LED alimentazione (verde)

- zh** **1** "配置：选择工作模式和灵敏度范围。LS / St / HS"  
**2** 灵敏度控制电位计 (%)  
**3** "等级数"选择器。  
**4** 时间延迟控制电位计。  
**5** 诊断按钮  
**6** 继电器输出状态 (黄色) LED. R  
**7** 表盘指针 / 电源指示 (绿色) LED

**LED Indication / Fonctionnement des voyants / LED-Anzeige / Indicación mediante LED / Indicazione a LED / LED 指示**

**3 Phase Control / Contrôle 3 phases / 3-Phasen-Steuerung / Control trifásico / Controllo a tre fasi / 3 相控制**

		RM22TR33 RM22TR31 RM22TA33 RM22TA31 RM22TU23 RM22TU21	RM22TG20
Dial Pointer / Power Supply indication (Green) LED (Except Un for RM22TG20) Voyant d'indicateur Pointeur du cadran/Alimentation (vert) (sauf Un pour M22TG20) Skalenzeiger / LED (grün) der Spannungsversorgung (außer Un für RM22TG20) Puntero del marcador/Indicador LED (verde) de la fuente de alimentación (excepto Un para RM22TG20) Indicatore / LED alimentazione (verde) (ad eccezione di Un per RM22TG20) 表盘指针 / 电源指示 (绿色) LED (对于 RM22TG20, 则不包括 Un)	Power supply L1 and L3 are present Alimentations L1 et L3 présentes Spannungsversorgung L1 und L3 vorhanden Fuentes de alimentación L1 y L3 presentes Alimentazione L1 e L3 presente 电源 L1 和 L3 存在	Permanent ON Toujours ON Permanent EIN Encendido permanente Acceso fissa 常亮	
	Power supply L1 and L3 are not present Alimentations L1 et L3 non présentes Spannungsversorgung L1 und L3 nicht vorhanden Fuentes de alimentación L1 y L3 no presentes Alimentazione L1 e L3 non presente 电源 L1 和 L3 不存在	Permanent OFF Toujours OFF Permanent AUS Apagado permanente Spento fissa 常灭	
Relay output status (yellow) LED R Voyant R de l'état de sortie relais (jaune). Status-LED (gelb) für Relaisausgang (R) LED (amarillo) de estado de salida de relé. R LED stato uscita relè (giallo) LED R 继电器输出状态 (黄色) LED R	Output are energized / Sorties sous tension Ausgang unter Spannung / Salidas energizadas Uscite alimentate / 输出端已通电	Permanent ON / Toujours ON / Permanent EIN Encendido permanente / Acceso fissa / 常亮	
	Output are de-energized / Sorties hors tension Ausgang spannungslos / Salidas desenergizadas Uscite non alimentate / 输出端已断电	Permanent OFF / Toujours OFF / Permanent AUS Apagado permanente / Spento fissa / 常灭	
	Timing are in-progress / Temporisation en cours Verzögerung aktiv / Temporización en curso Temporizzazione in corso / 计时正在进行中	Slow Blink Clignotement lent Langsames Blinken Parpadeo lento Lampeggia lentamente 缓慢闪烁	-
Fault detection indication(yellow) LED DEF (wherever the function is available on the product) Voyant DEF de détection de défaut (jaune) (lorsque la fonction est disponible sur le produit) LED (gelb) für Fehlererkennung (DEF) (sofern Funktion mit dem Produkt verfügbar) LED (amarillo) de indicación de detección de fallos DEF (siempre que la función esté disponible en el producto) LED di segnalazione guasti (giallo) DEF (se la funzione è disponibile sul prodotto) 故障检测指示 (黄色) LED DEF (凡是该功能在产品上可用时)	Phase Lost / Perte de phase / Phasenverlust / Pérdida de fase / Perdita fase / 相位丢失	Permanent OFF / Toujours OFF / Permanent AUS / Apagado permanente / Spento fissa / 常灭	-
	Phase Sequence Swap / Echange de séquences de phases Änderung der Phasenfolge / Inversión de secuencia de fases Scambio sequenza fase / 相位序列交换	Permanent ON / Toujours ON / Permanent EIN / Encendido permanente / Acceso fissa / 常亮	-
	<U	Slow Blink / Clignotement lent / Langsames Blinken / Parpadeo lento / Lampeggia lentamente / 缓慢闪烁	-
	>U	Fast Blink Clignotement rapide Schnelles Blinken Parpadeo rápido Lampeggia rapidamente 快速闪烁	-
Phase asymmetry / Asymétrie de phases / Phasenasymmetrie / Asimetría de fase / Asimmetria fase / 相位不对称	Slow Blink Clignotement lent Langsames Blinken Parpadeo lento Lampeggia lentamente 缓慢闪烁	-	

**Current Control Relay / Relais de contrôle d'intensité / Stromsteuerrelais / Relé de control de corriente / Relè di controllo corrente / 电流控制继电器**

		RM22JA31MR RM35JA32MR RM35JA32MT	RM22JA21MR
Dial Pointer / Power Supply indication (Green) LED / Voyant d'indicateur Pointeur du cadran/Alimentation (vert) / Skalenzeiger / LED (grün) der Spannungsversorgung / Puntero del marcador/Indicador LED (verde) de la fuente de alimentación / Indicatore / LED alimentazione (verde) / 表盘指针 / 电源指示 (绿色) LED	Power supply availability / Disponibilité de l'alimentation Spannungsversorgung verfügbar Disponibilidad de la fuente de alimentación Alimentazione presente / 电源可用性	Permanent ON / Toujours ON / Permanent EIN Encendido permanente / Acceso fissa / 常亮	
	Power supply not availability Indisponibilité de l'alimentation Spannungsversorgung nicht verfügbar No disponibilidad de la fuente de alimentación Alimentazione assente / 电源不可用性	Permanent OFF / Toujours OFF / Permanent AUS Apagado permanente / Spento fissa / 常灭	
Relay output status (yellow) LED R Voyant R de l'état de sortie relais (jaune). Status-LED (gelb) für Relaisausgang (R) LED (amarillo) de estado de salida de relé. R LED stato uscita relè (giallo) LED R 继电器输出状态 (黄色) LED R	Output are energized / Sorties sous tension Ausgang unter Spannung / Salidas energizadas Uscite alimentate / 输出端已通电	Permanent ON / Toujours ON / Permanent EIN Encendido permanente / Acceso fissa / 常亮	
	Output are de-energized / Sorties hors tension Ausgang spannungslos / Salidas desenergizadas Uscite non alimentate / 输出端已断电	Permanent OFF / Toujours OFF / Permanent AUS Apagado permanente / Spento fissa / 常灭	
	Timing are in-progress / Temporisation en cours Verzögerung aktiv / Temporización en curso Temporizzazione in corso / 计时正在进行中	Slow Blink / Clignotement lent Langsames Blinken Parpadeo lento Lampeggia lentamente 缓慢闪烁	-





**Voltage Control Relay / Relais de contrôle de tension / Spannungssteuerrelais / Relé de control de tensión / Relè di controllo tensione / 电压控制继电器**

		RM22UA31MR RM22UA32MR RM22UA33MR RM22UA33MT RM22UB34	RM22UA21MR RM22UA22MR RM22UA23MR
Dial Pointer / Power Supply indication (Green) LED Voyant d'indicateur Pointeur du cadran/Alimentation (vert) Skalenzeiger / LED (grün) der Spannungsversorgung Puntero del marcador/Indicador LED (verde) de la fuente de alimentación Indicatore / LED alimentazione (verde) 表盘指针 / 电源指示 (绿色) LED	Power supply availability / Disponibilité de l'alimentation / Spannungsversorgung verfügbar / Disponibilidad de la fuente de alimentación / Alimentazione presente / 电源可用性	Permanent ON / Toujours ON / Permanent EIN Encendido permanente / Acceso fiso / 常亮	
	Power supply not availability Indisponibilité de l'alimentation Spannungsversorgung nicht verfügbar No disponibilidad de la fuente de alimentación Alimentazione assente / 电源不可用性	Permanent OFF / Toujours OFF / Permanent AUS Apagado permanente / Spento fiso / 常灭	
Relay output status (yellow) LED R Voyant R de l'état de sortie relais (jaune). Status-LED (gelb) für Relaisausgang (R) LED (amarillo) de estado de salida de relé. R LED stato uscita relè (giallo) LED R 继电器输出状态 (黄色) LED R	Output are energized / Sorties sous tension Ausgang unter Spannung / Salidas energizadas Uscite alimentate / 输出端已通电	Permanent ON / Toujours ON / Permanent EIN Encendido permanente / Acceso fiso / 常亮	
	Output are de-energized / Sorties hors tension Ausgang spannungslos / Salidas desenergizadas Uscite non alimentate / 输出端已断电	Permanent OFF / Toujours OFF / Permanent AUS Apagado permanente / Spento fiso / 常灭	
	Timing are in-progress / Temporisation en cours Verzögerung aktiv / Temporización en curso Temporizzazione in corso / 计时正在进行中	Slow Blink / Clignotement lent Langsames Blinken Parpadeo lento Lampeggia lentamente / 缓慢闪烁	-

**Liquid Control Relay / Relais de contrôle du liquide / Kontrollrelais für Flüssigkeiten / Relé de control de liquido / Relè di controllo liquidi / 液体控制继电器**

		RM22LA32MR RM22LA32MT	RM22LG11MR RM22LG11MT
Dial Pointer / Power Supply indication (Green) LED Voyant d'indicateur Pointeur du cadran/Alimentation (vert) Skalenzeiger / LED (grün) der Spannungsversorgung Puntero del marcador/Indicador LED (verde) de la fuente de alimentación Indicatore / LED alimentazione (verde) 表盘指针 / 电源指示 (绿色) LED	Power supply availability / Disponibilité de l'alimentation / Spannungsversorgung verfügbar / Disponibilidad de la fuente de alimentación / Alimentazione presente / 电源可用性	Permanent ON / Toujours ON / Permanent EIN Encendido permanente / Acceso fiso / 常亮	
	Power supply not availability Indisponibilité de l'alimentation Spannungsversorgung nicht verfügbar No disponibilidad de la fuente de alimentación Alimentazione assente 电源不可用性	Permanent OFF / Toujours OFF / Permanent AUS Apagado permanente / Spento fiso / 常灭	
Relay output status (yellow) LED R Voyant R de l'état de sortie relais (jaune). Status-LED (gelb) für Relaisausgang (R) LED (amarillo) de estado de salida de relé. R LED stato uscita relè (giallo) LED R 继电器输出状态 (黄色) LED R	Output are energized / Sorties sous tension Ausgang unter Spannung / Salidas energizadas Uscite alimentate / 输出端已通电	Permanent ON / Toujours ON / Permanent EIN Encendido permanente / Acceso fiso / 常亮	
	Output are de-energized / Sorties hors tension Ausgang spannungslos / Salidas desenergizadas Uscite non alimentate / 输出端已断电	Permanent OFF / Toujours OFF / Permanent AUS Apagado permanente / Spento fiso / 常灭	
	Timing are in-progress / Temporisation en cours Verzögerung aktiv / Temporización en curso Temporizzazione in corso / 计时正在进行中	Slow Blink / Clignotement lent Langsames Blinken Parpadeo lento Lampeggia lentamente / 缓慢闪烁	-

- If the switch position is changed while the device is operating, all the LEDs flash, but the product continues to operate normally with the voltage selected at the time of energisation preceding the change of position. The LED's return to their normal state if the switch is returned to the original position selected prior to the last energisation.
- En cas de changement de position du commutateur pendant le fonctionnement du dispositif, tous les voyants clignotent, mais le produit continue de fonctionner normalement avec la tension sélectionnée lors de la mise sous tension avant le changement de position. Si le commutateur est remis sur la position sélectionnée avant la dernière mise sous tension, l'état normal des voyants est rétabli.
- Bei einer Änderung der Schalterposition während des Gerätebetriebs blinken alle LED-Anzeigen, der Produktbetrieb wird jedoch mit der bei der Ansteuerung vor der Positionsänderung ausgewählten Spannung normal fortgesetzt. Die LEDs kehren in ihren Normalzustand zurück, wenn der Schalter vor der letzten Ansteuerung in seine Ursprungsposition zurückgesetzt wird.
- Si se cambia la posición del selector mientras el dispositivo está en funcionamiento, todos los LED parpadean, pero el producto continúa funcionando con normalidad según la tensión seleccionada en el momento de la energización que precede al cambio de posición. Los LED vuelven a su estado normal si el conmutador recupera su posición original seleccionada antes de la última energización.
- Se la posizione dell'interruttore viene modificata durante il funzionamento del dispositivo, tutti i LED lampeggiano ma il prodotto continua a funzionare normalmente con la tensione selezionata al momento della messa in tensione precedente al cambio di posizione. I LED tornano allo stato normale se l'interruttore viene riportato alla posizione originale precedente all'ultima messa in tensione.
- 如果在设备工作时改变了开关的档位, 则所有 LED 都将闪烁, 但该产品会以在档位变化之前通电时所选择的电压继续正常工作。如果开关返回其在上一次通电之前所选择的原始位置, 则所有 LED 会恢复各自的正常状态。

























 Constantly "OFF" Toujours OFF Permanent „AUS“ Apagado permanente Spento fiso 常“灭”	 Constantly "ON" Toujours ON Permanent „EIN“ Encendido permanente Acceso fiso 常“亮”	 Slow Blinking Clignotement lent Langsames Blinken Parpadeo lento Lampeggio lento 缓慢闪烁
---	--	--

Note: Relay de-energized: 11-14, 21-24 opened  
Relay energized: 11-14, 21-24 closed  
Nota: Relé desenergizado: 11-14, 21-24 abiertos  
Relé energizado: 11-14, 21-24 cerrados

Remarque : Relais hors tension : 11-14, 21-24 ouvert  
Relais sous tension : 11-14, 21-24 fermé  
Nota: Relè non alimentato: 11-14, 21-24 aperte  
Relè alimentato: 11-14, 21-24 chiuse

Hinweis: Relais entregt: 11-14, 21-24 geöffnet  
Relais erregt: 11-14, 21-24 geschlossen  
注意: 继电器断电时: 11-14, 21-24 打开  
继电器通电时: 11-14, 21-24 关闭

Functions / Fonctions / Funktionen / Funciones / Funzione / 功能

<p><b>en</b> Power Supply R: Relay output Tt: Time delay</p>	<p><b>Function diagram:</b>   Power supply Off   Power supply On   Output open   Output closed</p>	<p><b>fr</b> Alimentation R: Sortie relais Tt: Temporisation</p>	<p><b>Diagramme:</b>   Hors tension   Sous tension   Sortie ouverte   Sortie fermée</p>	<p><b>es</b> Suministro de energía R: Relais de salida Tt: Retraso de tiempo</p>	<p><b>Diagrama de la función:</b>   Suministro de energía AUS   Suministro de energía EIN   Salida abierta   Salida cerrada</p>
<p><b>de</b> Stromversorgung R: Relaisausgang Tt: Verzögerungszeit</p>	<p><b>Funktionsdiagramm:</b>   Stromversorgung AUS   Stromversorgung EIN   Ausgang geöffnet   Ausgang geschlossen</p>	<p><b>it</b> Alimentazione R: Uscita relé Tt: Ritardo</p>	<p><b>Diagramma funzionale:</b>   Alimentazione assente   Alimentazione presente   Uscita aperta   Uscita chiusa</p>	<p><b>zh</b> 电源 R: 继电器输出 Tt: 时间延迟</p>	<p><b>功能图:</b>   电源关闭   电源开启   输出端打开   输出端关闭</p>

Current / Intensité / Strom / Corriente / Corrente / 电流

RM22JA21MR RM22JA31MR RM35JA32MR RM35JA32MT

- en** Undercurrent detection. < I
- fr** Détection de sous-intensité. < I
- de** Unterstromerkennung < I
- es** Detección de infracorriente. < I
- it** Rilevamento corrente insufficiente. < I
- zh** 欠流检测。< I

- en** Overcurrent detection. > I
- fr** Détection de surintensité. > I
- de** Überstromerkennung > I
- es** Detección de sobrecorriente. > I
- it** Rilevamento sovracorrente. > I
- zh** 过流检测。> I

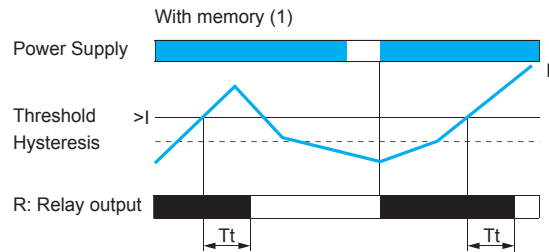
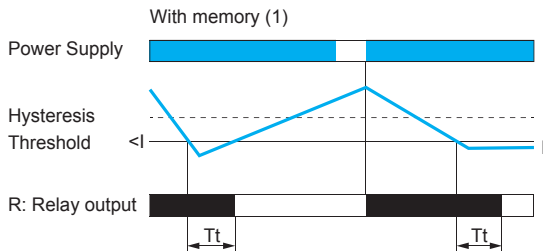
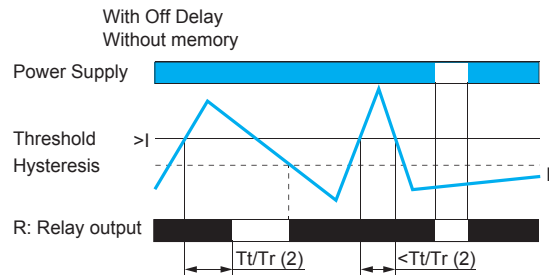
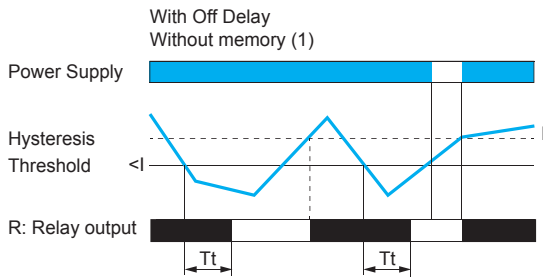

(1) Except RM22JA21MR  
(2) Tt: time delay after crossing of threshold (adjustable on front panel)  
for RM22JA21MR model, Tr: response time after cross the threshold

RM22JA31MR RM35JA32MR RM35JA32MT

- en** Overcurrent and Undercurrent >>
- fr** Surintensité et sous-intensité >>
- de** Über- und Unterstrom >>
- es** Sobrecorriente e infracorriente >>
- it** Sovracorrente e corrente insufficiente >>
- zh** 过流和欠流 >>

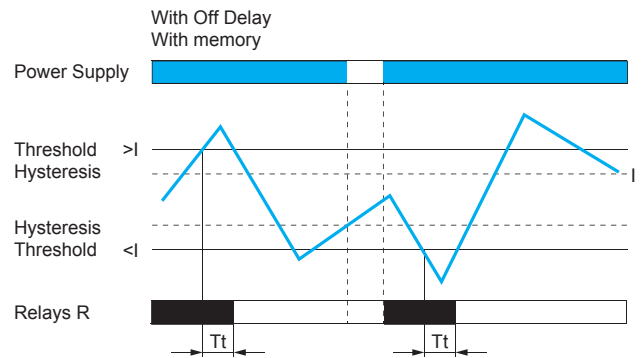
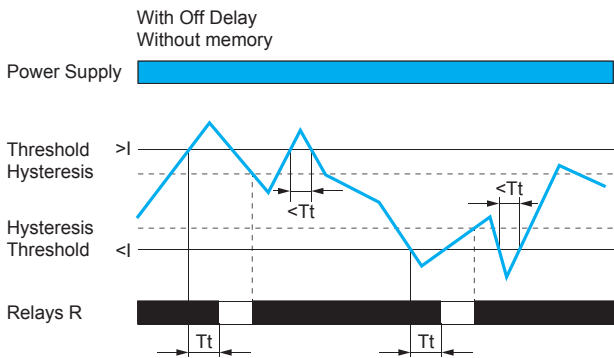

Tt: time delay after crossing of threshold (adjustable on front panel)

Voltage / Tension / Spannung / Tensión / Tensione / 电压

RM22UA21MR RM22UA22MR RM22UA23MR RM22UA31MR RM22UA32MR RM22UA33MR RM22UA33MT

- en Undervoltage Control. < U
- fr Contrôle de sous tension. < U
- de Unterspannungserkennung < U
- es Control de infratensión. < U
- it Controllo tensione insufficiente. < U
- zh 欠压控制. <U

- en Overvoltage Control. > U
- fr Contrôle de surtension. > U
- de Überspannungserkennung > U
- es Control de sobretensión. > U
- it Controllo sovratensione. > U
- zh 过压控制. >U

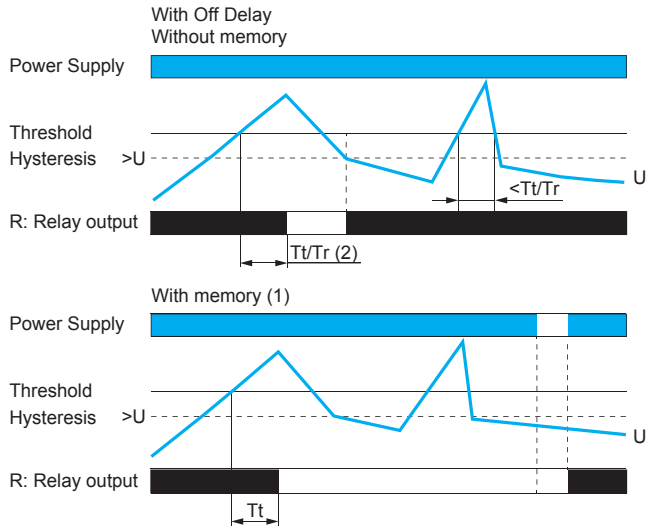
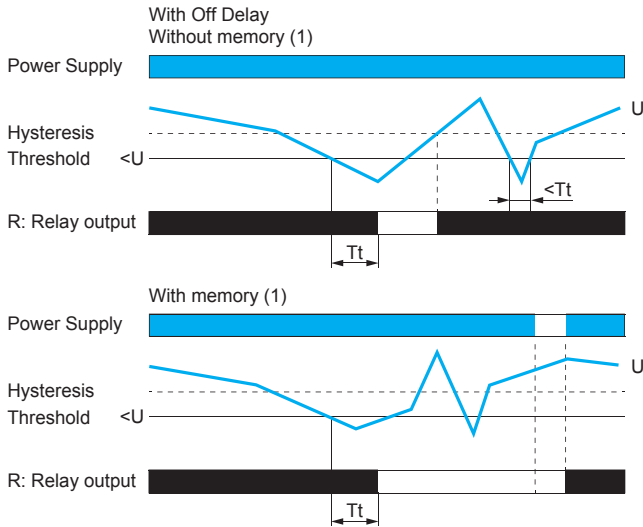

(1) Except RM22UA2\*  
(2) Tt: time delay after crossing of threshold (adjustable on front panel)  
for RM22UA2\* model, Tr: response time after cross the threshold

RM22UA31MR RM22UA32MR RM22UA33MR RM22UA33MT

- en Overvoltage and Undervoltage >U>
- de Über- und Unterspannung >U>
- it Sovratensione e tensione insufficiente >U>

- fr Surtension et sous-tension >U>
- es Sobretensión e infratensión >U>
- zh 过压和欠压 >U>

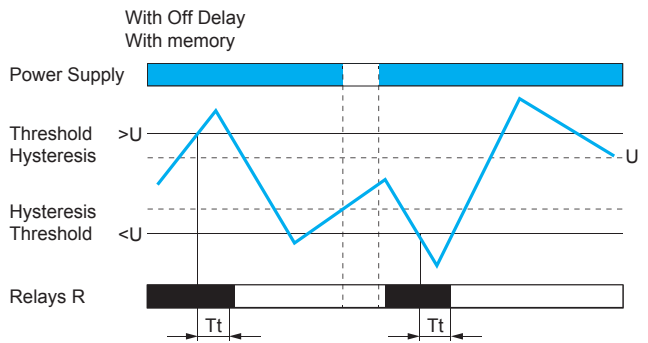
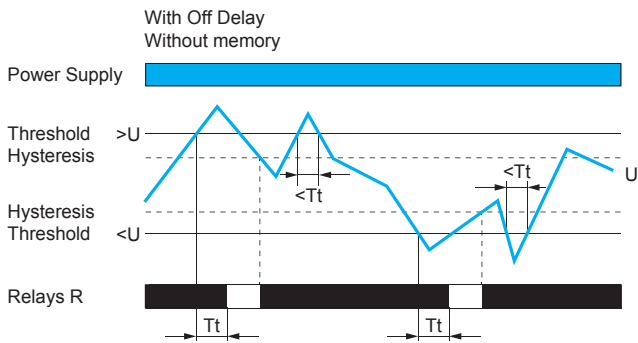

Tt: time delay after crossing of threshold (adjustable on front panel)

RM22UB34

- en Undervoltage Control. < U
- fr Contrôle de sous tension. < U
- de Unterspannungserkennung < U
- es Control de infratensión. < U
- it Controllo tensione insufficiente. < U
- zh 欠压控制 <U

- en Overvoltage Control. > U
- fr Contrôle de surtension. > U
- de Überspannungserkennung > U
- es Control de sobretensión. > U
- it Controllo sovratensione. > U
- zh 过压控制 >U

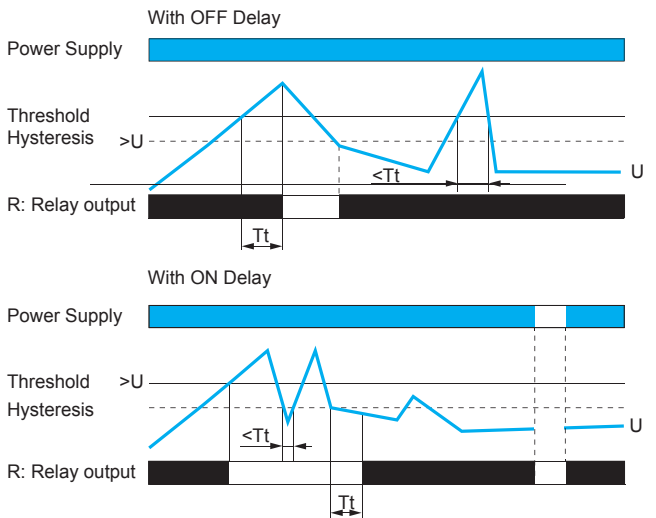
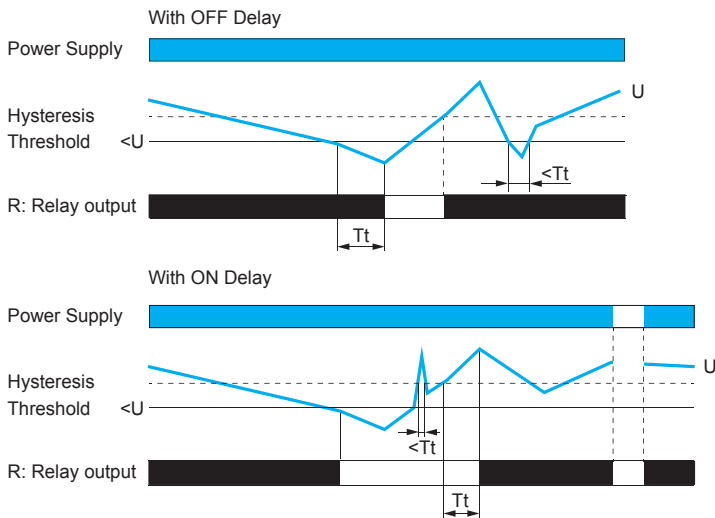

Tt: Time delay after crossing of threshold (adjustable on front panel)



3 Phase / 3 phases / 3 Phasen / Trifásico / Trifase / 3 相

RM22TG20

- en Sequence of phase L1, L2, L3.
- fr Séquence de phase L1, L2, L3.
- de Phasenfolge L1, L2, L3
- es Secuencia de fase L1, L2, L3.
- it Sequenza delle fasi L1, L2, L3.
- zh 相位 L1、L2 和 L3 的顺序

- en Phase Failure
- fr Défaillance de phase
- de Phasenfehler
- es Fallo de fase
- it Guasto fase
- zh 相位故障

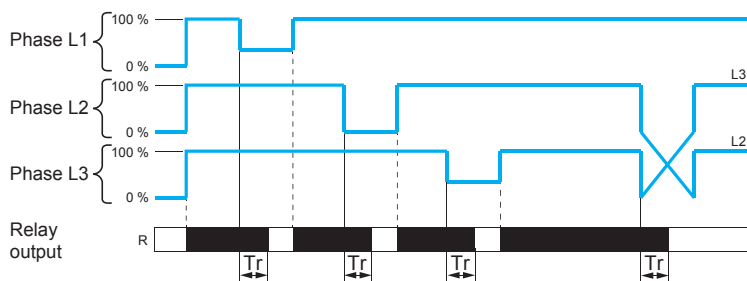

Note: Tr: response time after crossing the threshold

RM22TA31 RM22TA33

- en Sequence of phase L1, L2, L3.
- fr Séquence de phase L1, L2, L3.
- de Phasenfolge L1, L2, L3
- es Secuencia de fase L1, L2, L3.
- it Sequenza delle fasi L1, L2, L3.
- zh 相位 L1、L2 和 L3 的顺序

- en Phase Failure
- fr Défaillance de phase
- de Phasenfehler
- es Fallo de fase
- it Guasto fase
- zh 相位故障

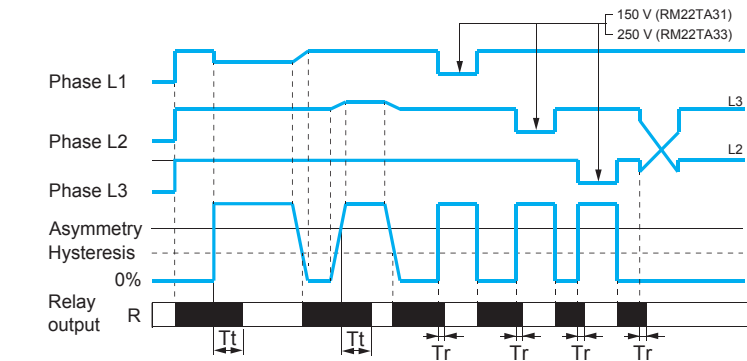

Note: Tt: time delay after crossing of threshold (adjustable on front panel)  
Tr: response time after crossing the threshold

- en Asymmetry. Asy.
- fr Asymétrie. Asy.
- de Asymmetrie (Asy.)
- es Asimetría. Asym.
- it Asimmetria. Asy.
- zh 不对称. Asy.

- en Phase Failure
- fr Défaillance de phase
- de Phasenfehler
- es Fallo de fase
- it Guasto fase
- zh 相位故障

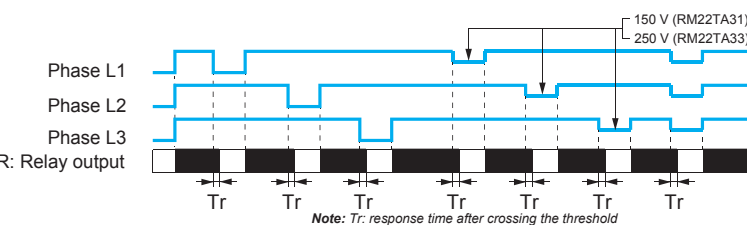

Note: Tr: response time after crossing the threshold

RM22TR31 RM22TR33

- en Sequence of phase L1, L2, L3.
- fr Séquence de phase L1, L2, L3.
- de Phasenfolge L1, L2, L3
- es Secuencia de fase L1, L2, L3.
- it Sequenza delle fasi L1, L2, L3.
- zh 相位 L1、L2 和 L3 的顺序

- en Phase Failure
- fr Défaillance de phase
- de Phasenfehler
- es Fallo de fase
- it Guasto fase
- zh 相位故障

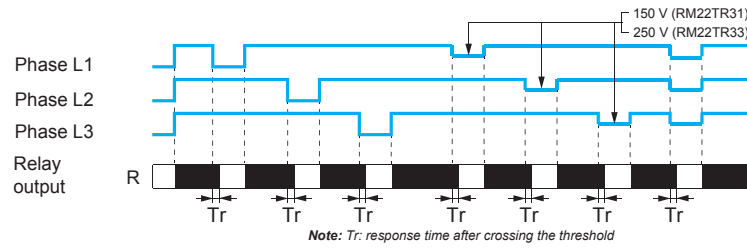

Note: Tr: response time after crossing the threshold

- en Overvoltage and Undervoltage
- fr Surtension et sous-tension
- de Über- und Unterspannung
- es Sobretensión e infratensión
- it Sovratensione e tensione insufficiente
- zh 过压和欠压

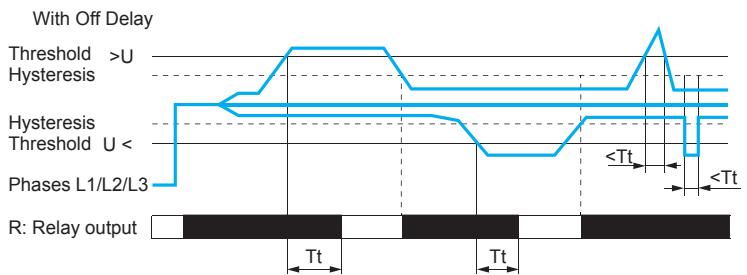

- en Overvoltage and Undervoltage
- fr Surtension et sous-tension
- de Über- und Unterspannung
- es Sobretensión e infratensión
- it Sovratensione e tensione insufficiente
- zh 过压和欠压

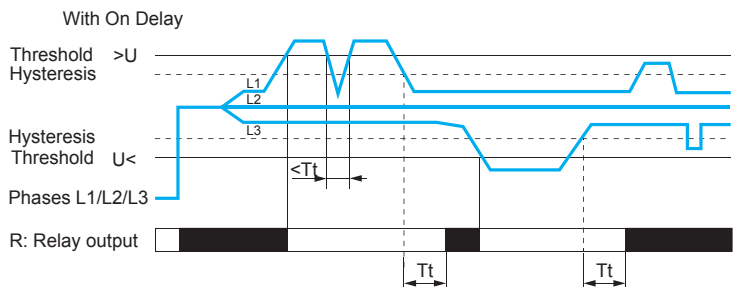

RM22TU21 RM22TU23

- en Sequence of phase L1, L2, L3.
- fr Séquence de phase L1, L2, L3.
- de Phasenfolge L1, L2, L3
- es Secuencia de fase L1, L2, L3.
- it Sequenza delle fasi L1, L2, L3.
- zh 相位 L1、L2 和 L3 的顺序

- en Phase Failure
- fr Défaillance de phase
- de Phasenfehler
- es Fallo de fase
- it Guasto fase
- zh 相位故障

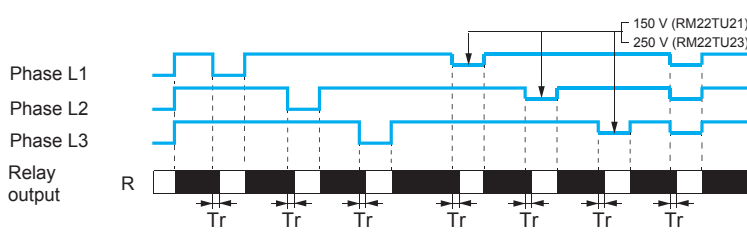

- en Undervoltage Control. < U
- fr Contrôle de sous tension. < U
- de Unterspannungserkennung < U
- es Control de infratensión. < U
- it Controllo tensione insufficiente. < U
- zh 欠压控制<U

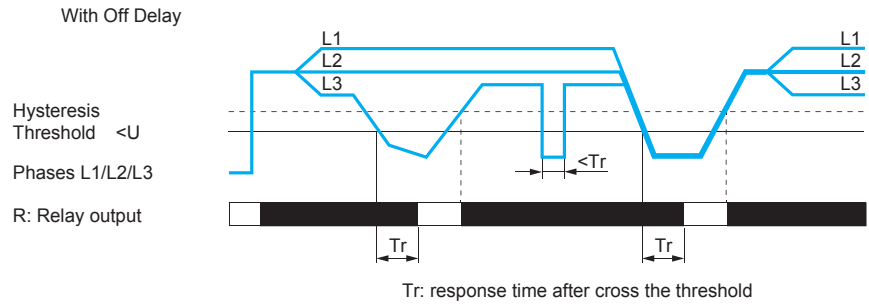

Level / Niveau / Füllstand / Nivel / Livello / 级别

RM22LA32MR RM22LA32MT

- en Fill/Empty function
  - fr Fonction Remplir/Vider
  - de Funktion Füllen/Leer
  - es Función de llenado/vaciado
  - it Funzione pieno/vuoto
  - zh 填充/清空功能
- 2 Level

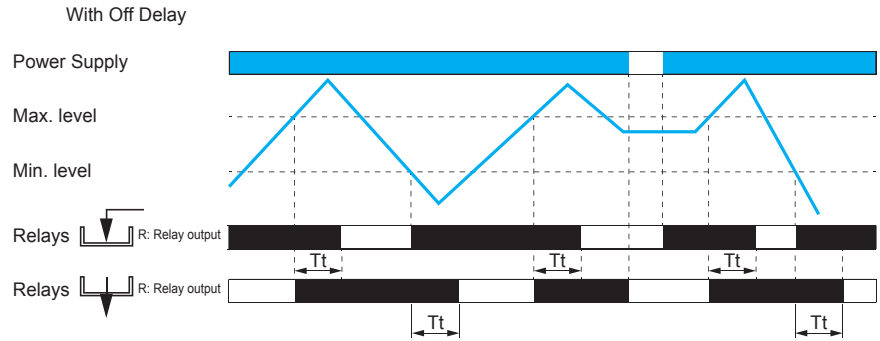

- en Fill/Empty function
  - fr Fonction Remplir/Vider
  - de Funktion Füllen/Leer
  - es Función de llenado/vaciado
  - it Funzione pieno/vuoto
  - zh 填充/清空功能
- 2 Level

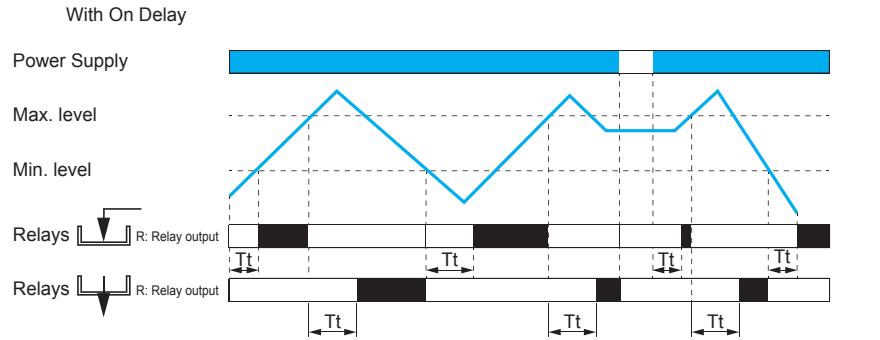

- en Empty function
  - fr Fonction Vider
  - de Funktion Leer
  - es Función de vaciado
  - it Funzione vuoto
  - zh 清空功能
- 1 Level

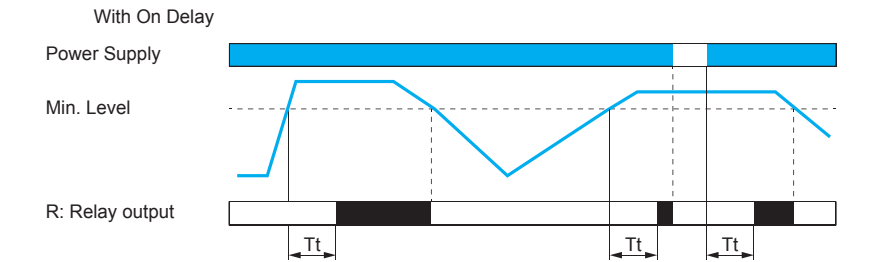

- en Empty function
  - fr Fonction Vider
  - de Funktion Leer
  - es Función de vaciado
  - it Funzione vuoto
  - zh 清空功能
- 1 Level

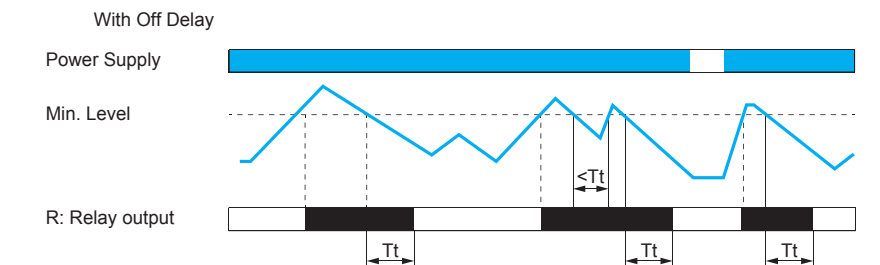

- en Fill function
  - fr Fonction Remplir
  - de Funktion Füllen
  - es Función de llenado
  - it Funzione pieno
  - zh 填充功能
- 1 Level

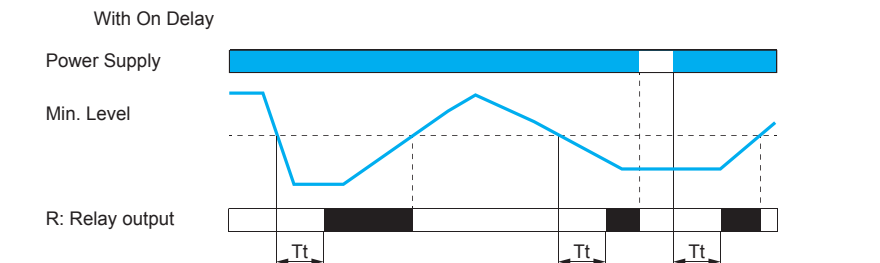

- en Fill function
- fr Fonction Remplir
- de Funktion Füllen
- es Función de llenado
- it Funzione pieno
- zh 填充功能

1 Level

With Off Delay

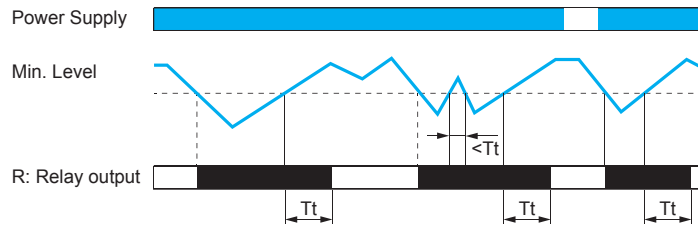

$T_t$ : time delay after crossing of threshold (adjustable on front panel)

RM22LG11MR RM22LG11MT

- en Fill/Empty function
- fr Fonction Remplir/Vider
- de Funktion Füllen/Leer
- es Función de llenado/vaciado
- it Funzione pieno/vuoto
- zh 填充/清空功能

2 Level

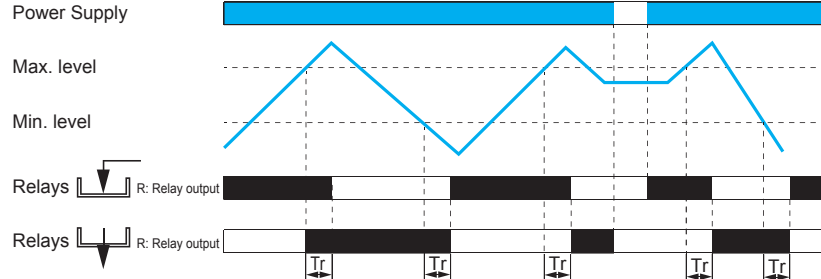

Note:  $T_r$ : response time after cross the threshold

- en Empty function
- fr Fonction Vider
- de Funktion Leer
- es Función de vaciado
- it Funzione vuoto
- zh 清空功能

1 Level

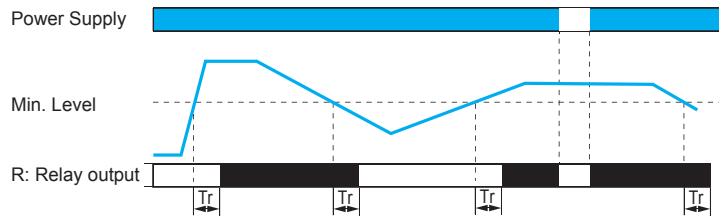

Note:  $T_r$ : response time after cross the threshold

- en Fill function
- fr Fonction Remplir
- de Funktion Füllen
- es Función de llenado
- it Funzione pieno
- zh 填充功能

1 Level

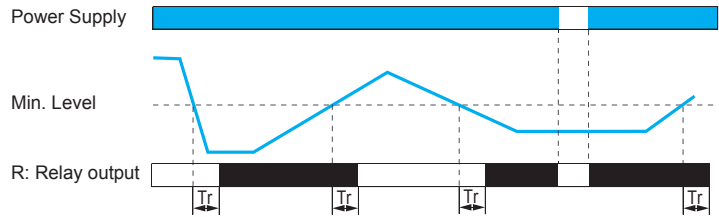

Note:  $T_r$ : response time after cross the threshold

Supply UN / Alimentation UN / Spannungsversorgung (Un) / UN alimentación / Alimentazione UN / 电源 UN

Hysteresis / Hystérésis / Hysterese- / Histéresis / Isteresi / 延时

Threshold / Seuil / grenzwert / Umbral / Soglia / 阈值

Relays / Relais / Relais / Relés / Relè / 继电器

Level / Niveau / Füllstand / Nivel / Livello / 级别

With On Delay / Délai activé / Mit Ansprechverzögerung / Con retardo al cierre / Con ritardo attivato / 开启延迟时

With Off Delay / Délai désactivé / Mit Rückfallverzögerung / Con retardo a la apertura / Con ritardo disattivato / 关闭延迟时

Phase L1,L2,L3 / Phase L1,L2,L3 / Phase L1,L2,L3 / Fase L1, L2, L3 / Fase L1,L2,L3 / 相位 L1、L2 和 L3

Max. level / Niveau max./ Höchstpegel / Nivel máx. / Livello max / 最高级别

Min. level / Niveau min. / Mindestpegel / Nivel mín. / Livello min / 最低级别

Without memory / Sans mémoire / Ohne Speicher / Sin memoria / Senza memoria / 无内存

With memory / Avec mémoire / Mit Speicher / Con memoria / Con memoria / 有内存

$T_t$ : Time delay after crossing of threshold (adjustable on front panel) / Temporisation après dépassement du seuil (réglage sur le panneau avant)

Verzögerungszeit nach Überschreitung des Grenzwerts (an Frontseite einstellbar) / Temporización después de cruzado del umbral (ajustable en el panel frontal)

ritardo temporale dopo il superamento della soglia (regolabile sul pannello frontale) / 超过阈值之后的时间延迟 (可在前面板上进行调整)

$T_r$ : Response time after cross the threshold / Temps de réponse après dépassement du seuil / Reaktionszeit nach Überschreitung des Schwellenwerts /

Tiempo de respuesta tras superar el umbral / Tempo di risposta dopo il superamento della soglia / 超越阈值后的响应时间

## 2 Cable / Câblez / Verdrahtung / Realice las conexiones / Realizzate il cablaggio / 电缆

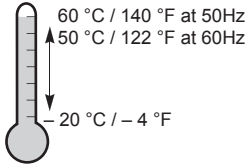

RM22TG20

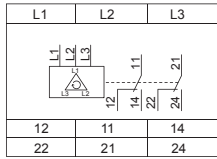

L1/L2/L3	3 AC~ 208-480 V 50-60 Hz 15 VA
	8 A / 250 V~

RM22TA31

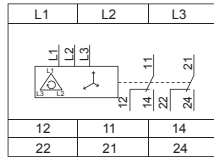

L1/L2/L3	3 AC~ 200-240 V 50-60 Hz 10 VA
	8 A / 250 V~

RM22TA33

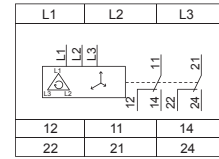

L1/L2/L3	3 AC~ 380-480 V 50-60 Hz 15 VA
	8 A / 250 V~

RM22TU21

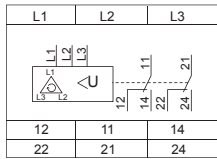

L1/L2/L3	3 AC~ 200-240 V 50-60 Hz 10 VA
	8 A / 250 V~

RM22TU23

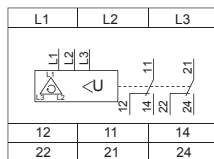

L1/L2/L3	3 AC~ 380-480 V 50-60 Hz 15 VA
	8 A / 250 V~

RM22TR31

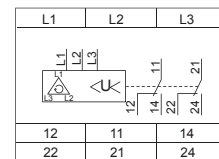

L1/L2/L3	3 AC~ 200-240 V 50-60 Hz 10 VA
	8 A / 250 V~

RM22TR33

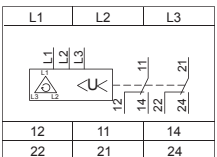

L1/L2/L3	3AC~ 380-480 V 50-60 Hz 15 VA
	8 A / 250 V~

RM22UA21MR

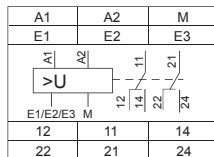

A1/A2	24-240 VAC 50-60 Hz 3.5 VA
	24-240 VDC 1.5 W
	8 A / 250 V~
E1/M	0.05-0.5 V AC/DC ~
E2/M	0.3-3 V AC/DC ~
E3/M	0.5-5 V AC/DC ~

RM22UA22MR

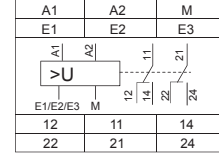

A1/A2	24-240 VAC 50-60 Hz 3.5 VA
	24-240 VDC 1.5 W
	8 A / 250 V~
E1/M	1-10V AC/DC ~
E2/M	5-50V AC/DC ~
E3/M	10-100V AC/DC ~

RM22UA23MR

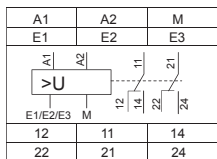

A1/A2	24-240 VAC 50-60 Hz 3.5 VA
	24-240 VDC 1.5 W
	8 A / 250 V~

E1/M	15-150 V AC/DC ~
E2/M	30-300 V AC/DC ~
E3/M	50-500 V AC/DC ~

RM22UA31MR

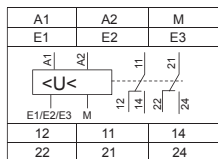

A1/A2	24-240 VAC 50-60 Hz 3.5 VA
	24-240 VDC 1.5 W
	8 A / 250 V~

E1/M	0.05-0.5 V AC/DC ~
E2/M	0.3-3 V AC/DC ~
E3/M	0.5-5 V AC/DC ~

RM22UA32MR

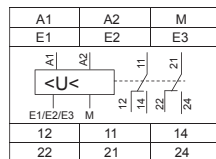

A1/A2	24-240 VAC 50-60 Hz 3.5 VA
	24-240 VDC 1.5 W
	8 A / 250 V~

E1/M	1-10 V AC/DC ~
E2/M	5-50 V AC/DC ~
E3/M	10-100 V AC/DC ~

RM22UA33MR

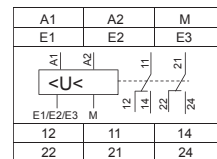

A1/A2	24-240 VAC 50-60 Hz 3.5 VA
	24-240VDC 1.5W
	8 A / 250 V~

E1/M	15-150 V AC/DC ~
E2/M	30-300 V AC/DC ~
E3/M	50-500 V AC/DC ~

RM22UA33MT

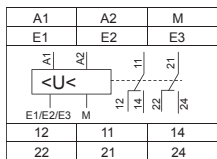

A1/A2	380-415 VAC 50-60 Hz 8 VA
	8 A / 250 V~

E1/M	15-150 V AC/DC ~
E2/M	30-300 V AC/DC ~
E3/M	50-500 V AC/DC ~

RM22UB34

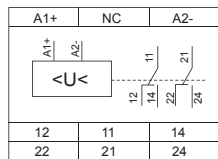

A1/A2	110-240 VAC 50-60 Hz 5 VA
	110-240 VDC 2W
	8 A / 250 V~

RM22JA21MR

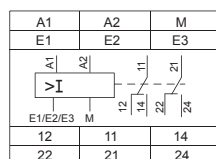

A1/A2	24-240 VAC 50-60 Hz 3.5 VA
	24-240 VDC 1.5 W
	8 A / 250 V~

E1/M	4-40 mA AC/DC ~
E2/M	20-200 mA AC/DC ~
E3/M	100-1000 mA AC/DC ~

RM22JA31MR

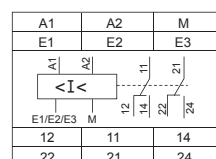

A1/A2	24-240 VAC 50-60 Hz 3.5 VA
	24-240 VDC 1.5 W
	8 A / 250 V~

E1/M	4-40 mA AC/DC ~
E2/M	20-200 mA AC/DC ~
E3/M	100-1000 mA AC/DC ~

RM35JA32MR

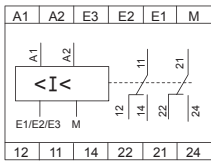

A1/A2	24-240 VAC 50-60 Hz 3.5 VA 24-240 VDC 1.5 W
	8 A / 250 V~

E1/M	0.15-1.5 A AC/DC ~
E2/M	0.5-5 A AC/DC ~
E3/M	1.5-15 A AC/DC ~

RM35JA32MT

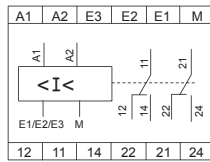

A1/A2	380-415 VAC 50-60 Hz 8 VA 8 A / 250 V~
-------	---

E1/M	0.15-1.5 A AC/DC ~
E2/M	0.5-5 A AC/DC ~
E3/M	1.5-15 A AC/DC ~

RM22LG11MR

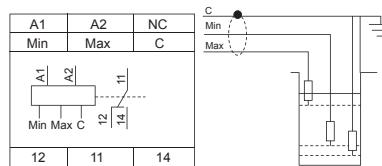

A1/A2	24-240 VAC 50-60 Hz 5 VA 24-240 VDC 1.5 W
	8 A / 250 V~

RM22LG11MT

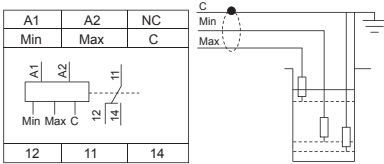

A1/A2	380-415 VAC 50-60 Hz 8 VA 8 A / 250 V~
-------	---

RM22LA32MR

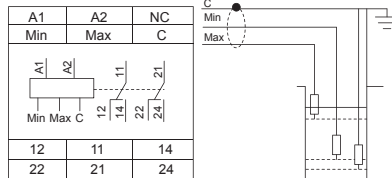

A1/A2	24-240 VAC 50-60 Hz 5 VA 24-240 VDC 1.5W
	8 A / 250 V~

HS	50 KΩ...1 MΩ
St	5 KΩ...100 KΩ
LS	250 Ω...5 KΩ

RM22LA32MT

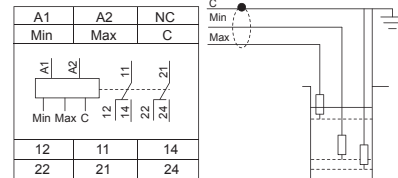

A1/A2	380-415 VAC 50-60 Hz 8 VA 8 A / 250 V~
-------	---

HS	50 KΩ...1 MΩ
St	5 KΩ...100 KΩ
LS	250 Ω...5 KΩ

### Wire sizes and torque / Calibre de fils et couple / Drahtstärken und Anzugsmoment / Tamaños de cable y par de apriete / Sezioni filo e coppia / 电线尺寸和扭矩

mm	0.24				
mm <sup>2</sup>		0.5...3.33	0.5...2.5	0.2...2.5	0.2...1.5
AWG		20...12	20...14	24...14	24...16

		N•m	0.6...1
		lb-in	5.3...8.8

### 3 Description / Description / Beschreibung / Descripción / Descizione / 产品功能

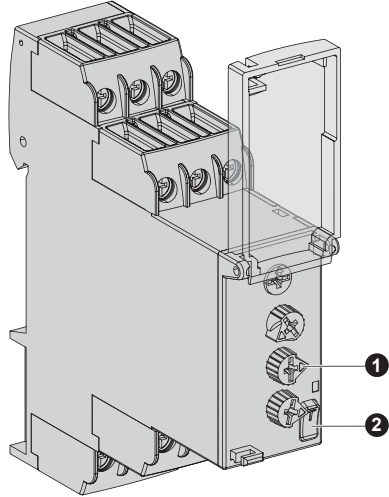

#### 1 Dial Pointer Indication / Indicateur du pointeur du cadran / Skalenzeiger

Indicación del puntero del marcador / Indicatore / 表盘指针指示

To ease reading on product setting in dark zone / Pour faciliter la lecture du cadran du produit dans l'obscurité  
Für eine bessere Erkennung der Produkteinstellung in dunklen Bereichen.

Facilita la lectura de la configuración del producto en zonas oscuras

Per facilitare la lettura in presenza di poca luce / 便于在昏暗地带读取产品设置

#### 2 Diagnostic Button / Bouton de diagnostic / Diagnosetaste / Botón de diagnóstico / Pulsante diagnostica

诊断按钮

To simulate relay energize, to check if the product working correctly in the machine

Pour simuler la mise sous tension du relais, pour vérifier si le produit fonctionne correctement dans la machine

Zur Simulation der Relaisansteuerung, um den ordnungsgemäßen Betrieb des Produkts in der Maschine zu prüfen.

Simula el arranque del relé y comprueba si el producto funciona correctamente en la máquina

Per simulare l'attivazione del relé e controllare se il prodotto funziona correttamente nella macchina

可模拟继电器通电以检查产品是否在机器中正常工作

### Diagnostic Button Working Logic / Logique de fonctionnement du bouton de diagnostic / Funktionsprinzip der Diagnosetaste Lógica de funcionamiento del botón de diagnóstico / Logica di funzionamento pulsante diagnostica / 诊断按钮工作逻辑

Power Supply Alimentation Spannungsversorgung Fuente de alimentación Alimentazione 电源	Input monitoring condition / Condition de contrôle de l'entrée / Überwachung des Eingangsstatus / Condición de monitorización de entrada / Condizione monitoraggio ingresso / 输入监控状况	Diagnostic Button Bouton de diagnostic Diagnosetaste Botón de diagnóstico Pulsante diagnostica 诊断按钮	Output Relays Status / Etat des relais de sortie Status der Ausgangsrelais / Estado de los relés de salida Stato relè uscita / 输出继电器状态
ON	Normal / Normal / Normal Normal / Normale / 正常	OFF	Relay Output closed / Sortie relais fermée / Relaisausgang geschlossen / Salida de relé cerrada / Uscita relè chiusa 继电器输出端关闭
		ON	Relay Output open / Sortie relais ouverte Relaisausgang geöffnet / Salida de relé abierta Uscita relè aperta / 继电器输出端开启
OFF	Not Normal / Non normal Nicht normal / No normal Non normale / 异常	OFF	No Action / Aucune action / Keine Aktion / Ninguna acción Nessuna azione / 无动作
		ON or OFF / ON ou OFF / EIN oder AUS Encendido o apagado Accesso o spento / 亮起或熄灭	



## 4 Set / Réglez / Einstellung / Regule / Regolate / 设定

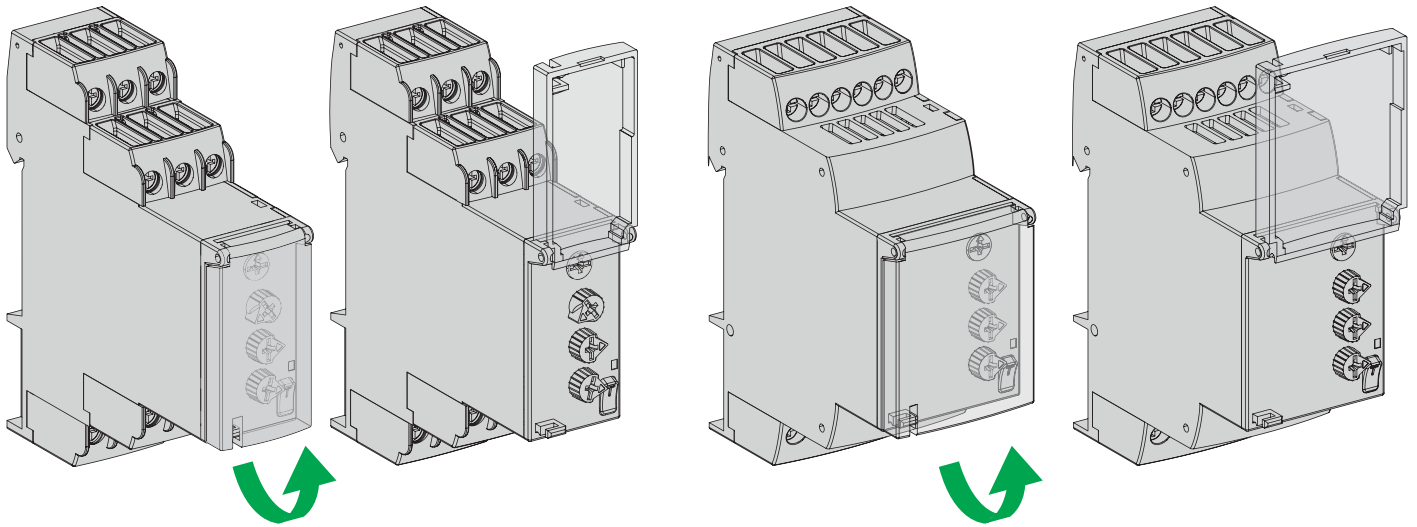

### Voltage setting example / Exemple de réglage de la tension / Beispiel für eine Spannungseinstellung / Ejemplo de ajuste de tensión / Esempio di impostazione tensione / 电压设置示例

To set voltage monitoring : 240V +/- 20% , No Memory function, Tt = 0.1s using RM22UA32MR

Calculation:

$$\text{To set U value (\%)} = \frac{\text{Nominal Voltage}}{\text{Full range Voltage}} \times 100\%$$

$$= \frac{240 \text{ V}}{300 \text{ V}} \times 100\%$$

$$= 80\%$$

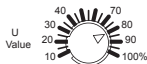

Step	1	2	3	4	5						
	E2/M: 30-300 V AV/DC										
V = 240 V +/- 20%	<table border="1"> <tr> <td>E1/M</td> <td>15-150 V AC/DC ~</td> </tr> <tr> <td>E2/M</td> <td>30-300 V AC/DC ~</td> </tr> <tr> <td>E3/M</td> <td>50-500 V AC/DC ~</td> </tr> </table>	E1/M	15-150 V AC/DC ~	E2/M	30-300 V AC/DC ~	E3/M	50-500 V AC/DC ~				
E1/M	15-150 V AC/DC ~										
E2/M	30-300 V AC/DC ~										
E3/M	50-500 V AC/DC ~										

Overvoltage and Undervoltage / Surtension et sous-tension / Über- und Unterspannung / Sobretensión e infratensión / Sovratensione e tensione insufficiente / 过压和欠压

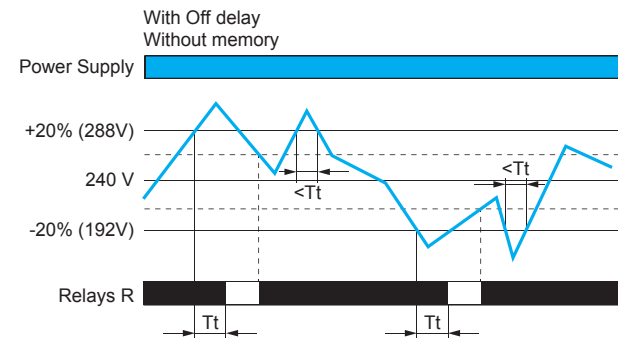

Product connection / Connexion du produit / Produktanschluss / Conexión del producto / Collegamento prodotto / 产品连接

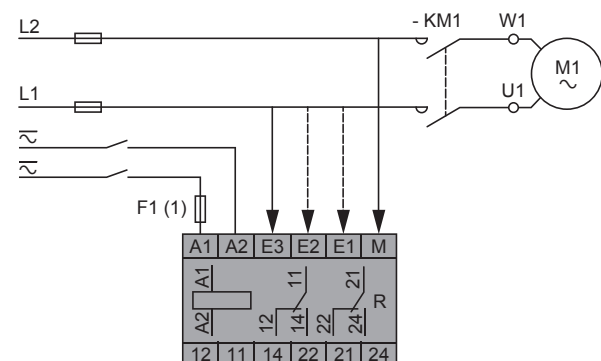

- 1) 1 A fuse. UL...Class CC ; IEC...gG
- Fusible 1 A. YK...Class CC ; IEC...gG
- Sicherung 1 A. UL...Klasse CC ; IEC...gG
- Fusible 1 A. UL...Classe CC ; IEC...gG
- Fusibile 1 A. Omologato UL...Classe CC ; IEC...gG
- 1 A 保险丝。UL...CC 级； IEC...gG

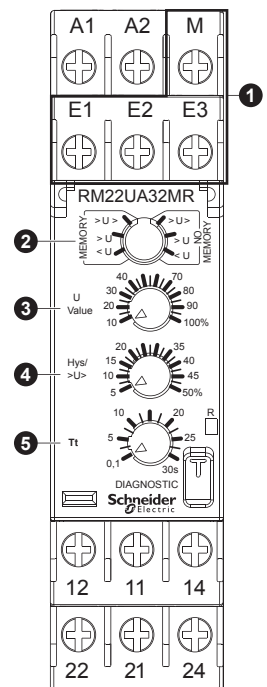



⊗ Off / Eteinte / Erloschen / Apagado / Spenta / 关闭

☀ On / Allumée / Brennt / Encendido / Accesa / 开启

⚡ Blinking / Clignotante / Blinkt / Intermitente / Lampeggiante / 闪烁

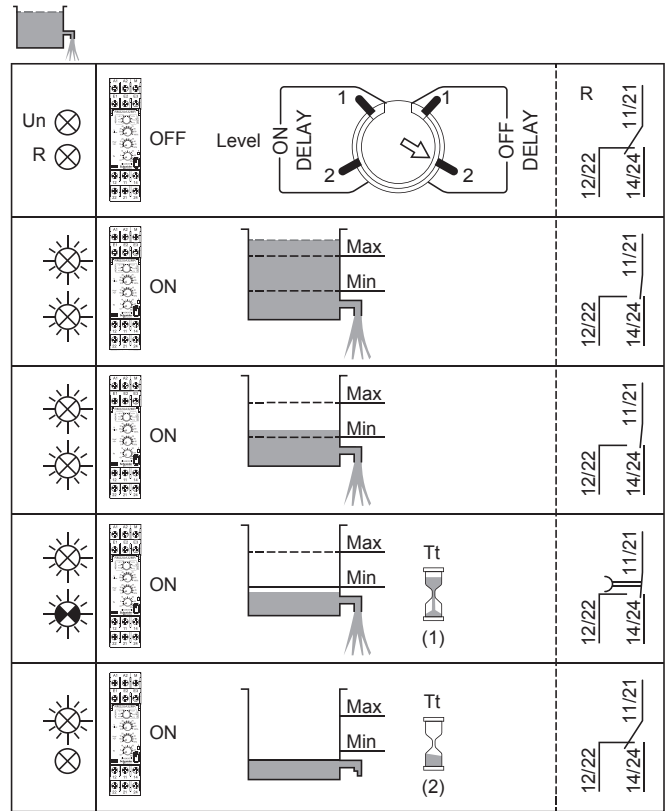
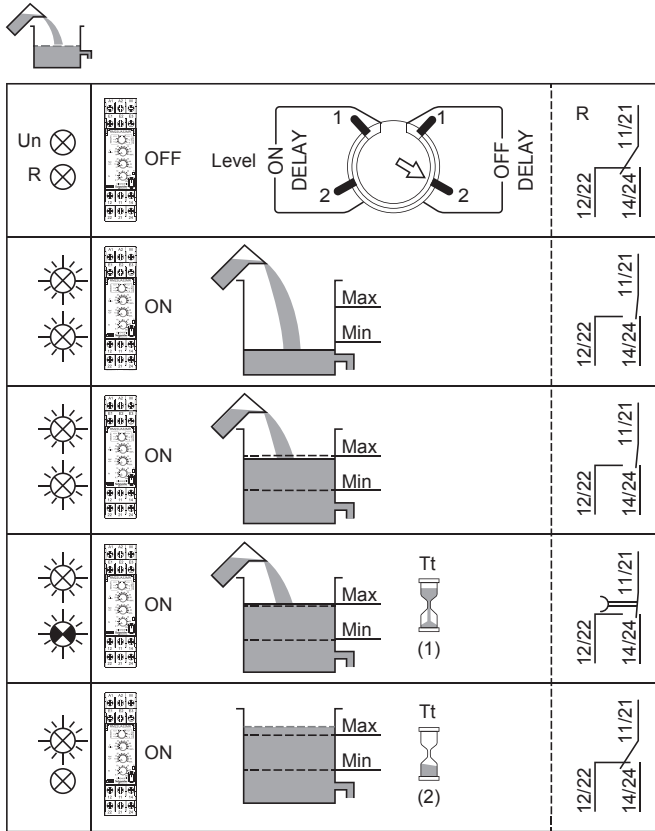

1) Time delay in progress / Temporisation en cours / Zeit läuft / Temporización en curso / Temporizzazione in corso / 时间延迟正在进行中  
 2) End for the preset time delay (adjustable on front panel) / Fin de la consigne de temporisation (réglable en façade) / Ende des Sollwerts der Verzögerung (an Frontseite einstellbar) / Fin de la consigna de temporización (adjustable en fachada) / Fine dell'istruzione di temporizzazione (regolabile sul pannello anteriore) / 结束预设的时间延迟 (可在前面板上进行调整)

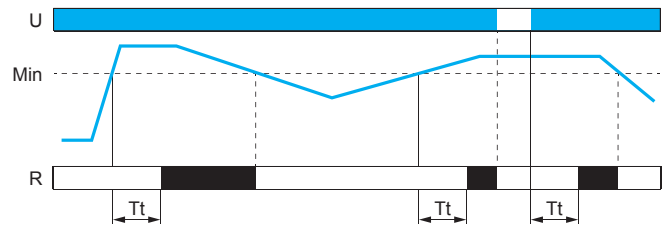
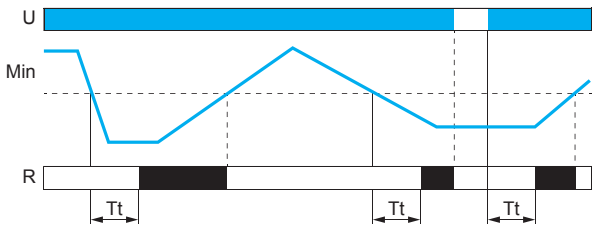
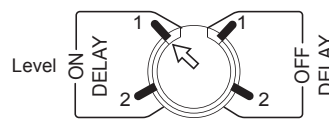
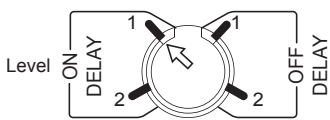
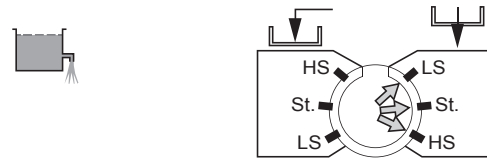
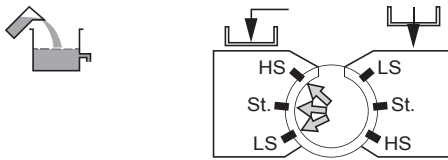

⊗ Off / Eteinte / Erloschen / Apagado / Spenta / 关闭

☀ On / Allumée / Brennt / Encendido / Accesa / 开启

☀ Blinking / Clignotante / Blink / Intermitente / Lampeggiante / 闪烁

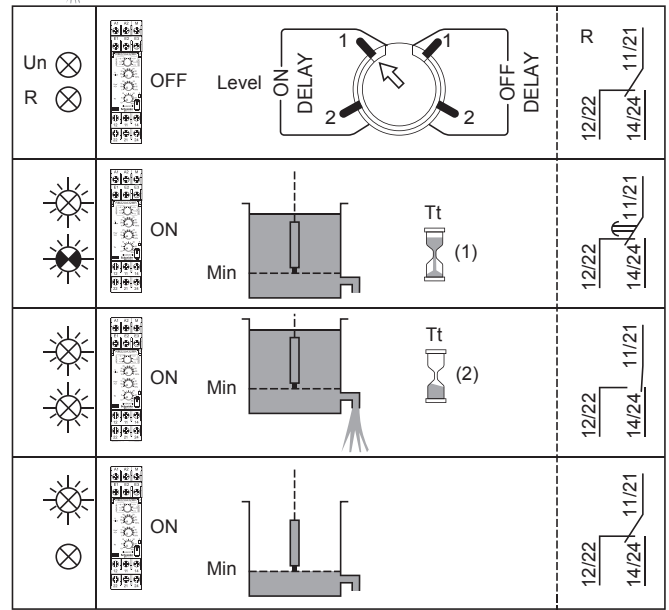
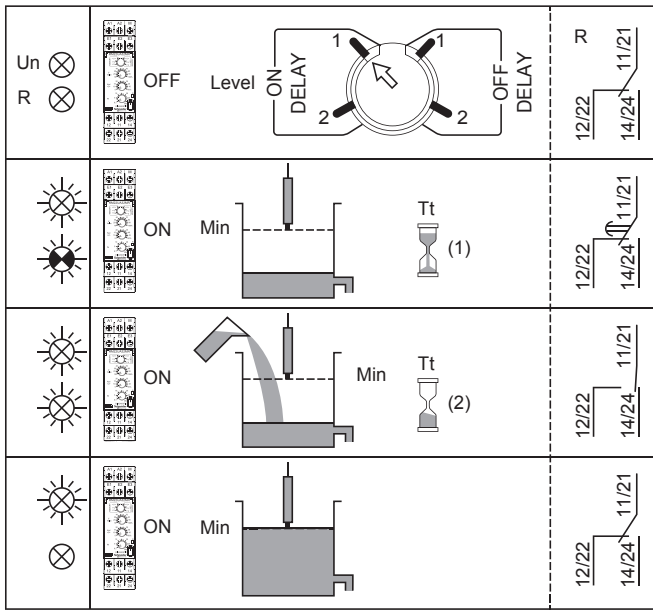

1) Time delay in progress / Temporisation en cours / Zeit läuft / Temporización en curso / Temporizzazione in corso / 时间延迟正在进行中

2) End for the preset time delay (adjustable on front panel) / Fin de la consigne de temporisation (réglable en façade) / Ende des Sollwerts der Verzögerung (an Frontseite einstellbar) / Fin de la consigna de temporización (adjustable en fachada) / Fine dell'istruzione di temporizzazione (regolabile sul pannello anteriore) / 结束预设的时间延迟 (可在前面板上进行调整)

**5 Delivery Safety Warning and Disclaimer / Avertissement de sécurité et limitation de responsabilité / Anwendungssicherheit und Haftungsausschluss / Advertencia de seguridad en la entrega y exención de responsabilidad / Avvertenze sulla Sicurezza e Responsabilità / 交付安全警告和免责声明**

**⚠ ⚠ DANGER / DANGER / GEFAHR / PERICOLO / PELIGRO / 危險**

<p><b>HAZARD OF ELECTRIC SHOCK, EXPLOSION OR ARC FLASH</b></p> <ul style="list-style-type: none"> <li>Disconnect all power before servicing equipment.</li> <li>Confirm that the product power supply voltage and its tolerances are compatible with those of the network.</li> </ul> <p><b>Failure to follow these instructions will result in death or serious injury.</b></p>	<p><b>RISQUE D'ELECTROCUTION, D'EXPLOSION OU D'ARC ELECTRIQUE</b></p> <ul style="list-style-type: none"> <li>Couper toutes les alimentations avant d'intervenir sur cet appareil.</li> <li>Assurez-vous que la tension d'alimentation du produit, avec ses tolérances, est compatible avec celle du réseau.</li> </ul> <p><b>Le non-respect de ces instructions entraînera le mort ou des blessures graves.</b></p>	<p><b>STROMSCHLAG-, EXPLOSIONS- ODER LICHTBOGENGEFAHR</b></p> <ul style="list-style-type: none"> <li>Vor dem Arbeiten an dem Gerät dessen Stromversorgung abschalten.</li> <li>Stellen Sie sicher, dass die Versorgungsspannung des Produkts einschließlich Toleranzen mit den Netzbedingungen vereinbar ist.</li> </ul> <p><b>Die Nichtbeachtung dieser Anweisungen wird den Tod oder schwere Körperverletzung zur Folge haben.</b></p>
<p><b>RIESGO DE ELECTROCUCIÓN, EXPLOSIÓN O ARCO ELÉCTRICO</b></p> <ul style="list-style-type: none"> <li>Desconecte toda alimentación antes de realizar el servicio.</li> <li>Asegúrese de que la tensión de alimentación del producto y sus tolerancias son compatibles con las de la red eléctrica.</li> </ul> <p><b>Si no se siguen estas instrucciones provocará lesiones graves o incluso la muerte.</b></p>	<p><b>RISCHIO DI SCOSSA ELETTRICA, DI ESPLOSIONE O DI OFTALMIA DA FLASH</b></p> <ul style="list-style-type: none"> <li>Scollegare l'apparecchio dalla presa di corrente prima di qualsiasi intervento.</li> <li>Assicurarsi che la tensione di alimentazione del prodotto e le relative tolleranze sia compatibile con quelle della rete.</li> </ul> <p><b>Il mancato rispetto di queste istruzioni provocherà morte o gravi infortuni.</b></p>	<p>存在电击、爆炸或电弧危险</p> <ul style="list-style-type: none"> <li>维修设备前，请断开所有电源连接。</li> <li>确认产品电源电压及其公差兼容于网络的这些参数。</li> </ul> <p>不按照上述规定操作会导致严重的人员伤亡。</p>

**⚠ WARNING / AVERTISSEMENT / WARNUNG / ADVERTENCIA / AVVERTENZA / 警告**

<p><b>UNINTENDED EQUIPMENT OPERATION OR INADEQUATE OVERCURRENT PROTECTION</b></p> <ul style="list-style-type: none"> <li>● Do not use in safety critical system.</li> <li>● Do not disassemble, repair or modify the product.</li> <li>● Install the product in the operating environment conditions described in this document.</li> <li>● Install properly rated fuses as recommended in this document.</li> </ul> <p><b>Failure to follow these instructions can result in death, serious injury, or equipment damage.</b></p>	<p><b>FONCTIONNEMENT INATTENDU DE L'EQUIPEMENT OU PROTECTION CONTRE LA SURINTENSITE INCORRECTE</b></p> <ul style="list-style-type: none"> <li>● Ne pas utiliser dans un système où la sécurité est critique.</li> <li>● Ce produit ne doit être ni démonté, ni réparé, ni modifié.</li> <li>● Installez le produit dans les conditions d'environnement d'exploitation, comme indiqué dans le présent document.</li> <li>● Installez des fusibles appropriés conformément aux recommandations du présent document.</li> </ul> <p><b>Le non-respect de ces directive peut entraîner la mort, des lésions corporelles graves ou des dommages matériels.</b></p>	<p><b>UNBEABSICHTIGTER GERÄTEBETRIEB ODER UNANGEMESSENER ÜBERSPANNUNGSSCHUTZ</b></p> <ul style="list-style-type: none"> <li>● Verwenden Sie das Produkt nicht in sicherheitskritischen Systemen.</li> <li>● Das Produkt darf weder zerlegt noch repariert oder verändert werden.</li> <li>● Installieren Sie das Produkt in einer Betriebsumgebung, die den in diesem Dokument beschriebenen Betriebsumgebungsbedingungen entspricht.</li> <li>● Installieren Sie Sicherungen mit geeigneten Nennwerten gemäß den Empfehlungen in diesem Dokument.</li> </ul> <p><b>Die Nichtbeachtung dieser Anweisung kann den Tod, Körperverletzung oder Materialschäden zur Folge haben.</b></p>
<p><b>FUNCIONAMIENTO IMPREVISTO DEL EQUIPO O PROTECCIÓN INADECUADA CONTRA SOBRECORRIENTE</b></p> <ul style="list-style-type: none"> <li>● No utilizar en sistemas críticos para la seguridad.</li> <li>● No desmonte, repare ni modifique este producto.</li> <li>● Instale el producto en las condiciones de entorno de funcionamiento descritas en este documento.</li> <li>● Instale fusibles con los valores nominales adecuados que se recomiendan en este documento.</li> </ul> <p><b>Si no se respetan estas precauciones pueden producirse graves lesiones, daños materiales o incluso la muerte.</b></p>	<p><b>FUNZIONAMENTO IMPREVISTO DELL'APPARECCHIATURA O PROTEZIONE INADEGUATA DALLA SOVRACORRENTE</b></p> <ul style="list-style-type: none"> <li>● Non utilizzare in un sistema critico per la sicurezza.</li> <li>● Non smontare, riparare o modificare il prodotto.</li> <li>● Installare il prodotto nelle condizioni ambientali di funzionamento descritte nel presente documento.</li> <li>● Installare fusibili con valore nominale adeguato, come indicato nel presente documento.</li> </ul> <p><b>La mancata osservanza di questa precauzione può causare gravi rischi per l'incolumità personale o danni alle apparecchiature.</b></p>	<p>意外的设备操作或不当的过压保护</p> <ul style="list-style-type: none"> <li>● 请勿在安全攸关系统中使用。</li> <li>● 切勿拆卸、修理或修改本产品。</li> <li>● 请在本文件所述的工作环境条件下安装本产品。</li> <li>● 请按本文件的建议正确地安装额定保险丝。</li> </ul> <p>不遵循上述说明可能导致人员伤亡或设备损坏。</p>

- en** Electrical equipment should be installed, operated, serviced, and maintained only by qualified personnel. No responsibility is assumed by Schneider Electric for any consequences arising out of the use of this material.
- fr** Les équipements électriques doivent être installés, exploités et entretenus par un personnel qualifié. Schneider Electric décline toute responsabilité quant aux conséquences de l'utilisation de ce matériel.
- de** Elektrische Geräte dürfen nur von Fachpersonal installiert, betrieben, gewartet und instand gesetzt werden. Schneider Electric haftet nicht für Schäden, die aufgrund der Verwendung dieses Materials entstehen.
- es** Sólo el personal de servicio cualificado podrá instalar, utilizar, reparar y mantener el equipo eléctrico. Schneider Electric no asume las responsabilidades que pudieran surgir como consecuencia de la utilización de este material.
- it** Le apparecchiature elettriche devono essere installate, usate e riparate solo da personale qualificato. Schneider Electric non assume nessuna responsabilità per qualunque conseguenza derivante dall'uso di questo materiale.
- zh** 电器设备的安装、操作、维修和维护工作仅限于合格人员执行。对于超出本资料所引发的任何后果，Schneider Electric 概不负责。

**Schneider Electric Industries SAS**  
 35, rue Joseph Monier  
 CS 30323  
 F - 92506 Rueil-Malmaison Cedex

施耐德电气生产工厂  
 无锡普洛菲斯电子有限公司  
 江苏省无锡国家高新技术产业开发区发  
 汉江路20号中国地区客服电话：  
 +86 400 810 1315

**This product must be installed, connected and used in compliance with prevailing standards and/or installation regulations.**  
 As standards, specifications and designs develop from time to time, always ask for confirmation of the information given in this publication.