

Monitoring Relays

3UG Monitoring Relays for Electrical and Additional Measurements

Line monitoring

Overview



Solid-state line monitoring relays provide maximum protection for mobile machines and plants or for unstable networks. Network and voltage faults can be detected early and rectified before far greater damage ensues.

Depending on the version, the relays monitor phase sequence, phase failure with and without N conductor monitoring, phase unbalance, undervoltage or overvoltage.

Phase unbalance is evaluated as the difference between the greatest and the smallest phase voltage relative to the greatest phase voltage. Undervoltage or overvoltage exists when at least one phase voltage deviates by 20 % from the set rated system voltage or the directly set limit values are overshoot or undershot. The rms value of the voltage is measured.

With the 3UG46 17 or 3UG46 18 relay, a wrong direction of rotation can also be corrected automatically.

Function

3UG45 11 monitoring relays

The 3UG45 11 phase sequenced relay monitors the phase sequence in a three-phase network. No adjustments are required for operation. The device has an internal power supply and works using the closed-circuit principle. If the phase sequence at the terminals L1-L2-L3 is correct, the output relay picks up after the delay time has elapsed and the LED is lit. If the phase sequence is wrong, the output relay remains in its rest position.

Note: When one phase fails, connected loads (motor windings, lamps, transformers, coils, etc.) create a feedback voltage at the terminal of the failed phase due to the network coupling. Because the 3UG45 11 relays are not resistant to voltage feedback, such a phase failure is not detected. Should this be required, then the 3UG45 12 monitoring relay must be used.

Correct phase sequence

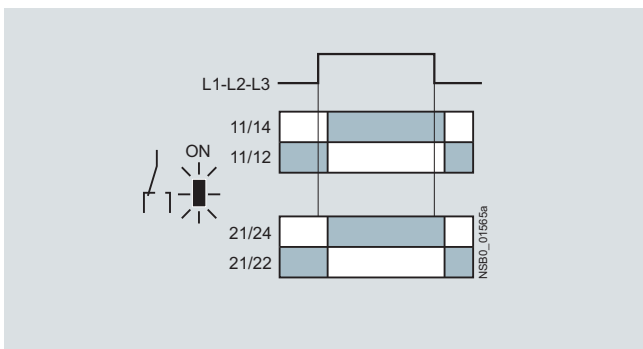

Wrong phase sequence

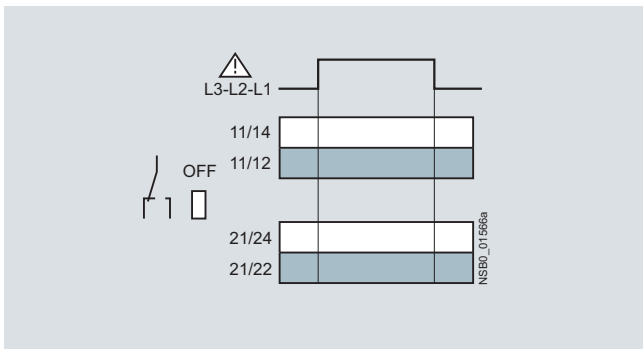

3UG45 12 monitoring relays

The 3UG45 12 line monitoring relay monitors three-phase networks with regard to phase sequence, phase failure and phase unbalance of 10 %. Thanks to a special measuring method, a phase failure is reliably detected in spite of the wide voltage range from 160 ... 690 V AC and feedback through the load of up to 90 %. The device has an internal power supply and works using the closed-circuit principle. No adjustments are required.

When the mains voltage is switched on, the green LED is lit. If the phase sequence at the terminals L1-L2-L3 is correct, the output relay picks up. If the phase sequence is wrong, the red LED flashes and the output relay remains in its rest position. If a phase fails, the red LED is permanently lit and the output relay drops.

Note: The red LED is a fault diagnostic indicator and does not show the current relay status. The 3UG45 12 monitoring relay is suitable for line frequencies of 50/60 Hz.

Phase failure

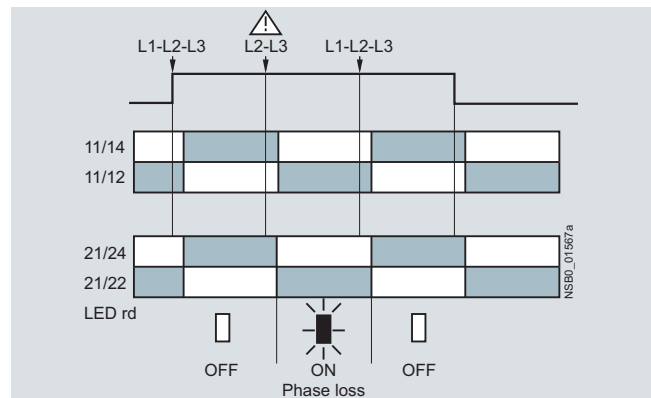

Wrong phase sequence

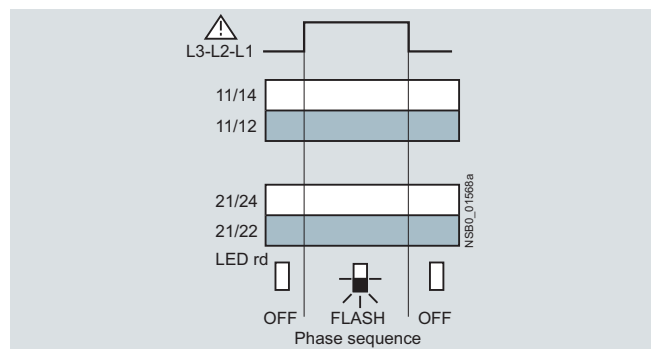

Monitoring Relays

3UG Monitoring Relays for Electrical and Additional Measurements

Line monitoring

3UG45 13 monitoring relays

The 3UG45 13 line monitoring relay monitors three-phase networks with regard to phase sequence, phase failure, phase unbalance and undervoltage of 20 %. The device has an internal power supply and works using the closed-circuit principle. The hysteresis is 5 %. The integrated response delay time is adjustable from 0 ... 20 s and responds to undervoltage. If the direction is incorrect, the device switches off immediately. Thanks to a special measuring method, a phase failure is reliably detected in spite of the wide voltage range from 160 ... 690 V AC and feedback up to 80 % through the load. When the mains voltage is switched on, the green LED is lit. If the phase sequence at the terminals L1-L2-L3 is correct, the output relay picks up. If the phase sequence is wrong, the red LED flashes and the output relay remains in its rest position. If a phase fails, the red LED is permanently lit and the output relay drops.

Note:

The red LED is a fault diagnostic indicator and does not show the current relay status. The 3UG45 13 monitoring relay is suitable for line frequencies of 50/60 Hz.

Phase failure and undervoltage

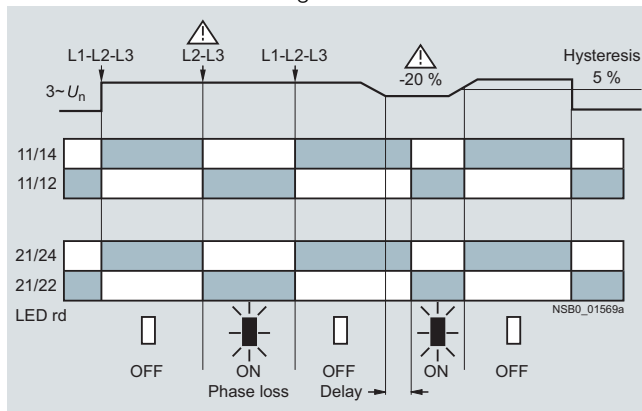

Wrong phase sequence

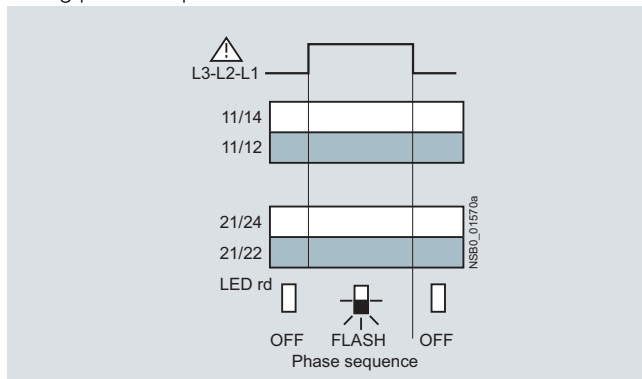

3UG46 14 monitoring relays

The 3UG46 14 line monitoring relay has a wide voltage range and an internal power supply. The device is equipped with a display and is parameterized using three buttons. It monitors three-phase networks with regard to phase unbalance from 5 ... 20 %, phase failure, undervoltage and phase sequence. The hysteresis is adjustable from 1 ... 20 V. In addition the device has a response delay and ON-delay from 0 ... 20 s in each case. The integrated response delay time responds to phase unbalance and undervoltage. If the direction is incorrect, the device switches off immediately. Thanks to a special measuring method, a phase failure is reliably detected in spite of the wide voltage range from 160 ... 690 V AC and feedback up to 80 % through the load.

The 3UG46 14 monitoring relay can be operated on the basis of either the open-circuit or closed-circuit principle and with manual or auto RESET.

With the closed-circuit principle selected

Wrong phase sequence

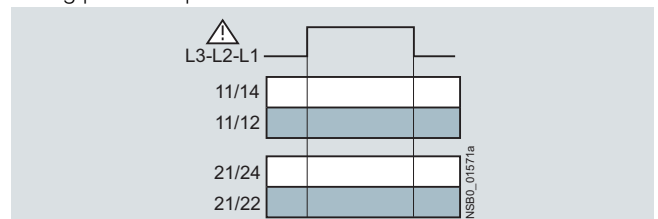

Phase failure

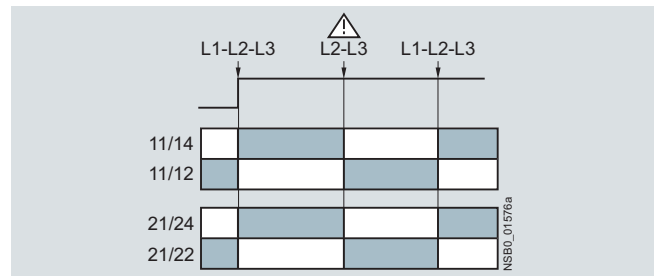

Undervoltage

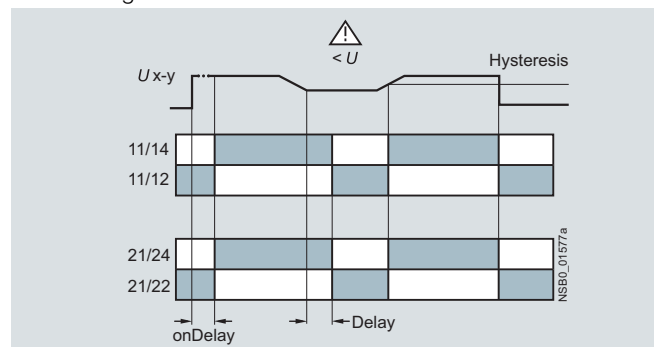

Unbalance

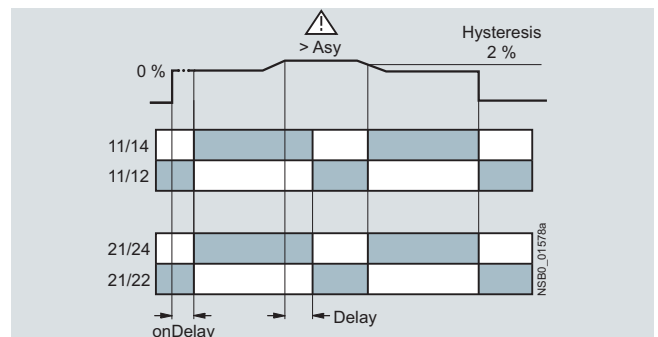

Monitoring Relays

3UG Monitoring Relays for Electrical and Additional Measurements

Line monitoring

3UG46 15/3UG46 16 monitoring relays

The 3UG46 15/3UG46 16 line monitoring relay has a wide voltage range and an internal power supply. The device is equipped with a display and is parameterized using three buttons. The 3UG46 15 device monitors three-phase networks with regard to phase failure, undervoltage, overvoltage and phase sequence. The 3UG46 16 monitoring relay monitors the neutral conductor as well. The hysteresis is adjustable from 1 ... 20 V. In addition the device has two separately adjustable delay times for overvoltage and undervoltage from 0 ... 20 s in each case. If the direction is incorrect, the device switches off immediately. Thanks to a special measuring method, a phase failure is reliably detected in spite of the wide voltage range from 160 ... 690 V AC and feedback through the load of up to 80 %.

The 3UG46 15/ 3UG46 16 monitoring relay can be operated on the basis of either the open-circuit or closed-circuit principle and with manual or auto RESET.

With the closed-circuit principle selected

Wrong phase sequence

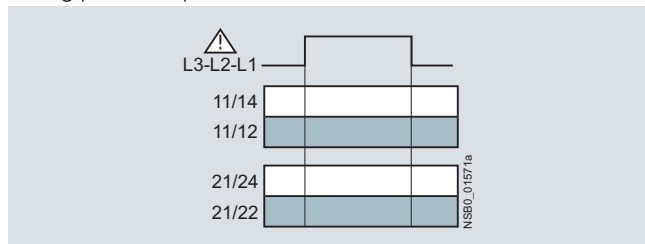

Phase failure

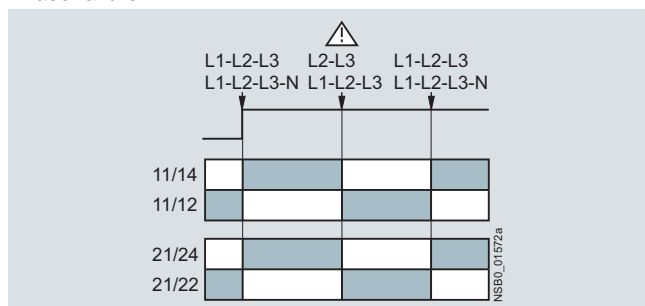

Undervoltage

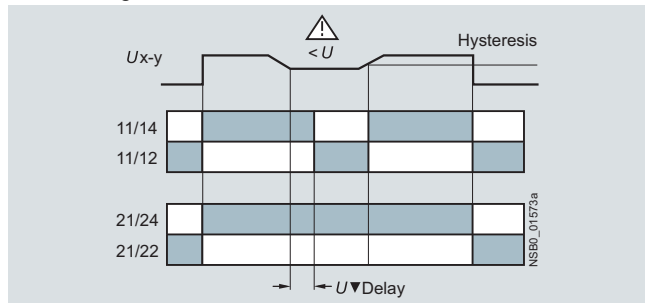

Overvoltage

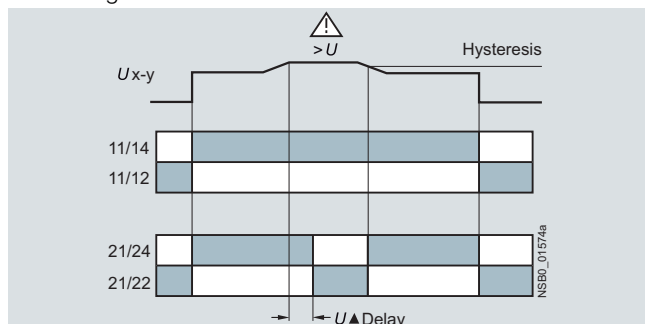

3UG46 17/3UG46 18 monitoring relays

The 3UG46 17/ 3UG46 18 line monitoring relay has an internal power supply and can automatically correct a wrong direction of rotation. Thanks to a special measuring method, a phase failure is reliably detected in spite of the wide voltage range from 160 ... 690 V AC and feedback through the load of up to 80 %. The device is equipped with a display and is parameterized using three buttons. The 3UG46 17 line monitoring relay monitors three-phase networks with regard to phase sequence, phase failure, phase unbalance, undervoltage and overvoltage. The 3UG46 18 monitoring relay monitors the neutral conductor as well. The hysteresis is adjustable from 1 ... 20 V. In addition the device has delay times from 0 ... 20 s in each case for overvoltage, undervoltage, phase failure and phase unbalance. The 3UG46 17/ 3UG46 18 monitoring relay can be operated on the basis of either the open-circuit or closed-circuit principle and with manual or auto RESET. The one changeover contact is used for warning or disconnection in the event of power system faults (voltage, unbalance), the other responds only to a wrong phase sequence. In conjunction with a contactor reversing assembly it is thus possible to change the direction automatically.

With the closed-circuit principle selected

Phase failure

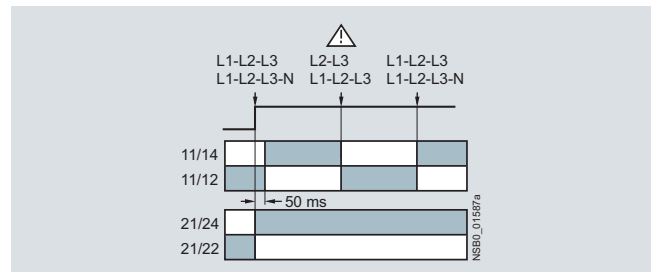

Undervoltage

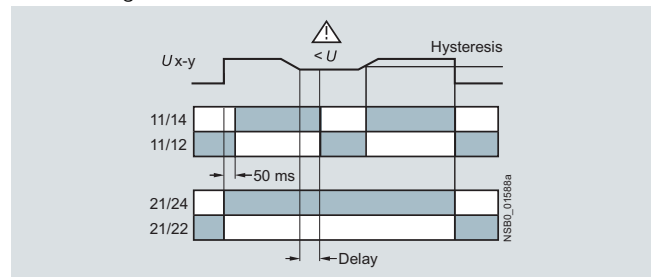

Overvoltage

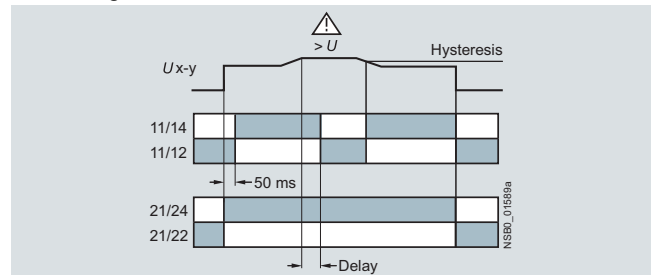

Unbalance

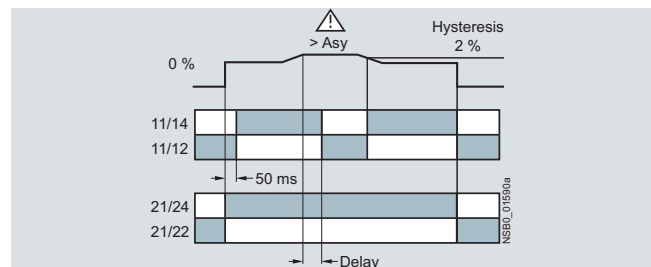



Monitoring Relays

3UG Monitoring Relays for Electrical and Additional Measurements

Line monitoring

Technical specifications

Type		3UG45 11- ..N20	3UG45 11- ..P20	3UG45 11- ..Q20	3UG45 12	3UG45 13	3UG46 14	3UG46 15 3UG46 17	3UG46 16 3UG46 18	
General data										
Rated control supply voltage U_s	V	160 ... 260	320 ... 500	420 ... 690	160 ... 690				90 ... 400	
Absolute limit values										
Rated frequency	Hz	50/60								
Rated power , typical										
• At AC 230 V	W/VA	2/4	--	--	2/2.5					
• At AC 400 V	W/VA	--	2/8	--	2/3.5					
• At AC 460 V	W/VA	--	--	2/8	2/4					
Width	mm	22.5								
RESET		Auto-RESET					Automatic/manual			
Principle of operation		Closed-circuit					Closed-circuit, open-circuit (3UG46 17/3UG46 18: closed-circuit)			
Availability time after application of U_s	ms	200			1.000					
Response time once a switching threshold is reached	ms	Max. 450								
Unbalance	%	--			10	20	0; 5 ... 20	3UG46 15/3UG46 16: Through threshold values 3UG46 17/3UG46 18: 0; 5 ... 20		
Adjustable tripping delay time	s	--				0.1 ... 20				
Adjustable ON-delay time	s	--					0.1 ... 20	--		
Mains buffering time , minimum	ms	10			30					
Rated insulation voltage U_i Degree of pollution 3 Overvoltage category III acc. to IEC 60664	V	690								
Rated impulse withstand voltage	kV	6								
Permissible ambient temperature										
• During operation	°C	-25 ... +60								
• During storage	°C	-40 ... +85								
EMC tests¹⁾		IEC 60947-5-1/IEC 61000-6-2/IEC 61000-6-4								
Degree of protection acc. to IEC 60529		IP40 Enclosure IP20 Terminals								
Mounting position		Any								
Vibration resistance acc. to IEC 60068-2-6		1 ... 6 Hz: 15 mm; 6 ... 500 Hz: 2 g								
Shock resistance acc. to IEC 60068-2-27	g/ms	15/11								
Connection type		 Screw terminals								
• Terminal screw		M 3 (standard screwdriver, size 2 and Pozidriv 2)								
• Solid	mm ²	1 x (0.5 ... 4)/2 x (0.5 ... 2.5)								
• Finely stranded with end sleeve	mm ²	1 x (0.5 ... 2.5)/2 x (0.5 ... 1.5)								
• AWG cables, solid or stranded	AWG	2 x (20 ... 14)								
• Tightening torque	Nm	0.8 ... 1.2								
Connection type		 Spring-type terminals								
• Solid	mm ²	2 x (0.25 ... 1.5)								
• Finely stranded, with end sleeves	mm ²	2 x (0.25 ... 1.5)								
• Finely stranded	mm ²	2 x (0.25 ... 1.5)								
• AWG cables, solid or stranded	AWG	2 x (24 ... 16)								
Measuring circuit										
Measuring range AC 50/60 Hz rms value	V	160 ... 260	320 ... 500	420 ... 690	160 ... 690					
Setting range	V					200...690	160...690		90...400	
Measuring accuracy	%	--			±5					
Repeat accuracy At constant parameters	%	--			±1					
Setting accuracy		--			±10 % referred to setting		±1 V			
Accuracy of digital display		--					±1 digit			
Deviations for temperature fluctuations	%/°C	--			±0.1					
Hysteresis for voltage	V	--			5 % from setting		1 ... 20 V			
Hysteresis for unbalance	%	--					(setting - 2) 3UG46 17/3UG46 18: (setting - 2)			
Deviation for frequency fluctuation	%	--			±1					

1) Important: This is a Class A product. In the household environment this device may cause radio interference. In this case the user must introduce suitable measures.

Monitoring Relays

3UG Monitoring Relays for Electrical and Additional Measurements

Line monitoring

	3UG45 11- ..N20	3UG45 11- ..P20	3UG45 11- ..Q20	3UG45 12	3UG45 13	3UG46 14	3UG46 15 3UG46 17	3UG46 16 3UG46 18
Control circuit								
Load capacity of the output relay								
• Conventional thermal current I_{th}	A	5						
Rated operational current I_g at								
• AC-15 at 24 ... 400 V	A	3						
• DC-13 at 24 V	A	1						
• DC-13 at 125 V	A	0.2						
• DC-13 at 250 V	A	0.1						
Minimum contact load at 17 V DC	mA	5						
Output relay with DIAZED fuse	A	4						
gL/gG operational class								
Electrical endurance AC-15, 3 A, Million operating cycles	0.1							
Mechanical endurance Million operating cycles	10							

Dimensional drawings

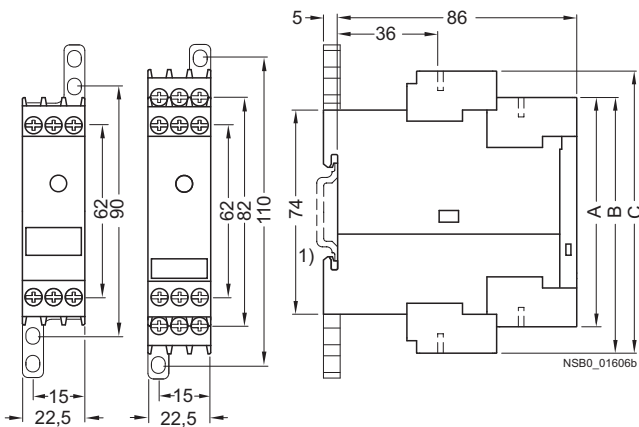

Type	3UG45 11-.A 3UG45 12-.A	3UG45 11-.B 3UG45 12-.B 3UG45 13 3UG46 14 3UG46 15 3UG46 17	3UG46 16 3UG46 18
	A	B	C

Removable terminal

Screw-type terminal	83	92	102
Spring-loaded terminal	84	94	103

1) For standard mounting rail according to EN 60715.

Monitoring Relays

3UG Monitoring Relays for Electrical and Additional Measurements

Line monitoring

Schematics

3UG45 11-A
3UG45 12-A

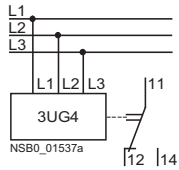

3UG45 11-B
3UG45 12-B
3UG45 13
3UG46 14
3UG46 15
3UG46 17

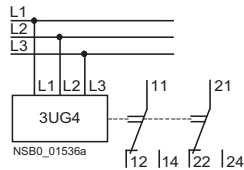

3UG46 16
3UG46 18

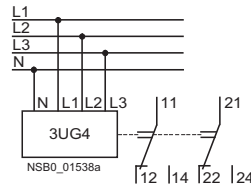

Note: It is not necessary to protect the measuring circuit for device protection. The protective device for line protection depends on the cross-section used.

Position of the terminals

3UG45 11-A
3UG45 12-A

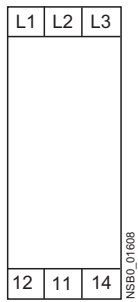

3UG45 11-B
3UG45 12-B
3UG45 13
3UG46 14
3UG46 15
3UG46 17

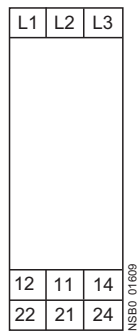

3UG46 16
3UG46 18

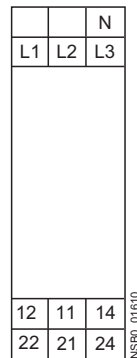

Monitoring Relays for Electrical and Additional Measurements

Voltage monitoring

Overview



The relays monitor single-phase AC voltages (rms value) and DC voltages against the set threshold value for overshoot and undershoot. The devices differ with regard to their power supply (internal or external).

Function

3UG46 33 monitoring relays

The 3UG46 33 voltage monitoring relay has an internal power supply and performs overshoot, undershoot or window monitoring of the voltage depending on how it is parameterized. The device is equipped with a display and is parameterized using three buttons.

The operating and measuring range extends from 17 ... 275 V AC/DC. The threshold values for overshoot or undershoot can be freely configured within this range. If one of these threshold values is reached, the output relay responds according to the set principle of operation as soon as the tripping delay time has elapsed. This delay time U_{Del} can be set from 0.1 ... 20 s like the ON-delay time $onDelay$.

The hysteresis is adjustable from 0.1 ... 150 V. The device can be operated on the basis of either the open-circuit or closed-circuit principle and with manual or auto RESET. One output change-over contact is available as signaling contact.

With the closed-circuit principle selected

Overvoltage

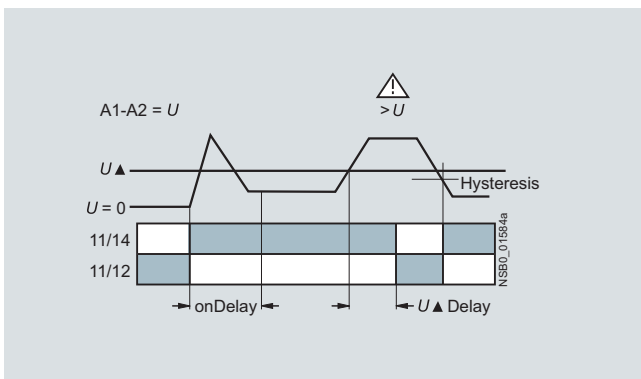

Undervoltage

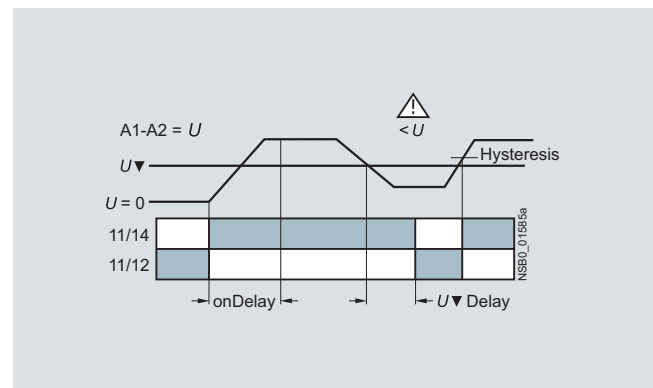

Window monitoring

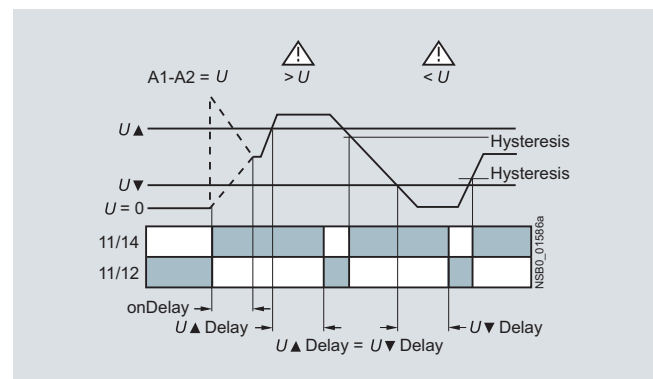

Monitoring Relays

3UG Monitoring Relays for Electrical and Additional Measurements

Voltage monitoring

3UG46 31/3UG46 32 monitoring relays

The 3UG46 31/3UG46 32 voltage monitoring relay is supplied with an auxiliary voltage of 24 V AC/DC or 24 ... 240 V AC/DC and performs overshoot, undershoot or window monitoring of the voltage depending on how it is parameterized. The device is equipped with a display and is parameterized using three buttons.

The measuring range extends from 0.1 V ... 60 V or 10 ... 600 V AC/DC. The threshold values for overshoot or undershoot can be freely configured within this range. If one of these threshold values is reached, the output relay responds according to the set principle of operation as soon as the delay time has elapsed. This delay time U_{Del} can be set from 0.1 ... 20 s.

The hysteresis can be set from 0.1 ... 30 V or 0.1 ... 300 V. The device can be operated on the basis of either the open-circuit or closed-circuit principle and with manual or auto RESET. One output changeover contact is available as signaling contact.

With the closed-circuit principle selected

Overvoltage

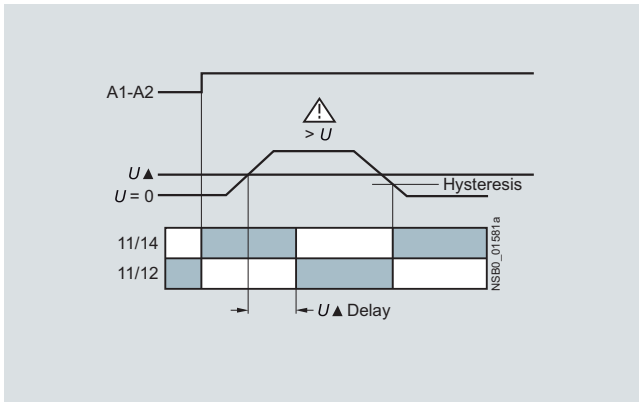

Undervoltage

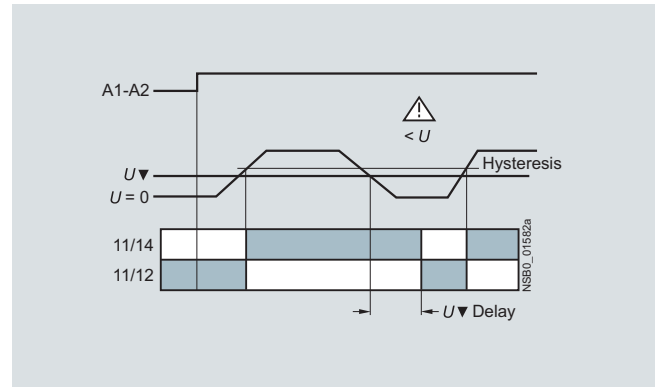

Window monitoring

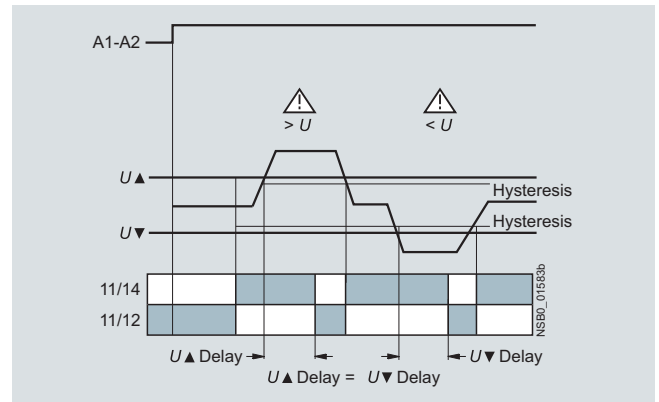



Monitoring Relays

3UG Monitoring Relays for Electrical and Additional Measurements

Voltage monitoring

Technical specifications

		3UG46 31- .AA	3UG46 31- .AW	3UG46 32- .AA	3UG46 32- .AW	3UG46 33
General data						
Rated control supply voltage U_s	V	24 AC/DC	24...240 AC/DC	24 AC/DC	24...240 AC/DC	17 ... 275 ¹⁾ AC/DC
Rated frequency for AC	Hz	50/60				40 ... 500
Operating range	V	20.4 ... 27.6	20.4 ... 264	20.4 ... 27.6	20.4 ... 264	17...275
Rated power in W/VA	VA	2/4				
Width	mm	22.5				
RESET		Automatic/manual				
Availability time after application of U_s	ms	1000				
Response time once a switching threshold is reached	ms	Max. 450				
Adjustable tripping delay time	s	0.1 ... 20				
Adjustable ON-delay time	s	--				0.1 ... 20
Mains buffering time , minimum	ms	10				
Rated insulation voltage U_i Degree of pollution 3 Overvoltage category III acc. to IEC 60664	V	690				
Rated impulse withstand voltage U_{imp}	kV	6				
Protective separation acc. to IEC 60947-1, Annex N	V	300				
Permissible ambient temperature • During operation • During storage	°C	-25 ... +60 -40 ... +85				
EMC tests²⁾		IEC 60947-5-1/IEC 61000-6-2/IEC 61000-6-4				
Degree of protection acc. to IEC 60529		IP40 Enclosure IP20 Terminals				
Mounting position		Any				
Vibration resistance acc. to IEC 60068-2-6		1 ... 6 Hz: 15 mm; 6 ... 500 Hz: 2 g				
Shock resistance acc. to IEC 60068-2-27	g/ms	15/11				
Connection type		 Screw terminals				
• Terminal screw • Solid • Finely stranded with end sleeve • AWG cables, solid or stranded • Tightening torque	mm ² mm ² AWG Nm	M 3 (standard screwdriver, size 2 and Pozidriv 2) 1 x (0.5 ... 4)/2 x (0.5 ... 2.5) 1 x (0.5 ... 2.5)/2 x (0.5 ... 1.5) 2 x (20 ... 14) 0.8 ... 1.2				
Connection type		 Spring-type terminals				
• Solid • Finely stranded, with end sleeves • Finely stranded • AWG cables, solid or stranded	mm ² mm ² mm ² AWG	2 x (0.25 ... 1.5) 2 x (0.25 ... 1.5) 2 x (0.25 ... 1.5) 2 x (24 ... 16)				
Measuring circuit						
Permissible measuring range single-phase AC/DC voltage	V	0.1 ... 68		10 ... 650		17 ... 275
Setting range single-phase voltage	V	0.1 ... 60		10 ... 600		17 ... 275
Measuring frequency AC/DC	Hz	40 ... 500				40 ... 500
Measuring accuracy	%	5				
Repeat accuracy at constant parameters	%	1				
Accuracy of digital display		±1 digit				
Deviations for temperature fluctuations	%/°C	±0.1				
Hysteresis for single-phase voltage	V	0.1 ... 30		0.1 ... 300		0.1 ... 150
Control circuit						
Load capacity of the output relay • Conventional thermal current I_{th}	A	5				
Rated operational current I_e • AC-15 at 24 ... 400 V • DC-13 at 24 V • DC-13 at 125 V • DC-13 at 250 V	A	3 1 0.2 0.1				
Minimum contact load at 17 V DC	mA	5				
Output relay with DIAZED fuse gL/gG operational class	A	4				
Electrical endurance AC-15, 3 A, million operating cycles		0.1				
Mechanical endurance million operating cycles		10				

¹⁾ Absolute limit values.

²⁾ Important: This is a Class A product. In the household environment this device may cause radio interference. In this case the user must introduce suitable measures.

Monitoring Relays

3UG Monitoring Relays for Electrical and Additional Measurements

Voltage monitoring

Dimensional drawings

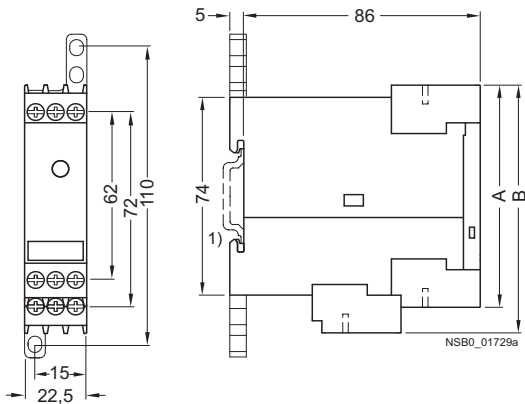

Type	3UG46 31 3UG46 32 3UG46 33
	A B

Removable terminal

Screw-type terminal	83	92
Spring-loaded terminal	84	94

1) For standard mounting rail according to EN 60715.

Schematics

3UG46 31-AA30
3UG46 32-AA30

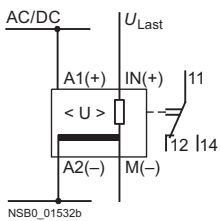

3UG46 31-AW30
3UG46 32-AW30

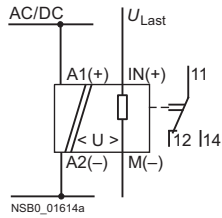

3UG46 33

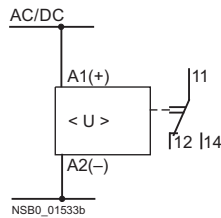

Note: It is not necessary to protect the measuring circuit for device protection. The protective device for line protection depends on the cross-section used.

Position of the terminals

3UG46 31
3UG46 32

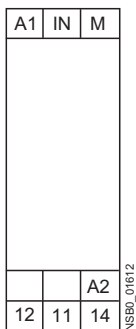

3UG46 33

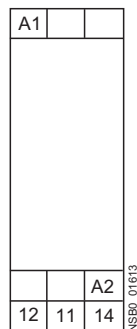

Monitoring Relays

3UG Monitoring Relays for Electrical and Additional Measurements

Current monitoring

Overview



The relays monitor single-phase AC currents (rms value) and DC currents against the set threshold value for overshoot and undershoot. They differ with regard to their measuring ranges and supply voltage types.

Function

3UG46 21/3UG46 22 monitoring relays

The 3UG46 21/3UG46 22 current monitoring relay is supplied with an auxiliary voltage of 24 V AC/DC or 24 ... 240 V AC/DC and performs overshoot, undershoot or window monitoring of the current depending on how it is parameterized. The device is equipped with a display and is parameterized using three buttons.

The measuring range extends from 3 ... 500 mA or 0.05 ... 10 A. The rms value of the current is measured. The threshold values for overshoot or undershoot can be freely configured within this range. If one of these threshold values is reached, the output relay responds according to the set principle of operation as soon as the tripping delay time I_{Del} has elapsed. This time and the ON-delay time on_{Del} are adjustable from 0.1 ... 20 s.

The hysteresis is adjustable from 0.1 ... 250 mA or 0.01 ... 5 A. The device can be operated with manual or auto RESET and on the basis of either the open-circuit or closed-circuit principle. Following options are available: Response of the output relay when the supply voltage $U_s = ON$ is applied or not until the lower measurement range limit of the measuring current ($I > 3 \text{ mA} / 50 \text{ mA}$) is reached. One output changeover contact is available as signaling contact.

With the closed-circuit principle selected upon application of the supply voltage

Current overshoot

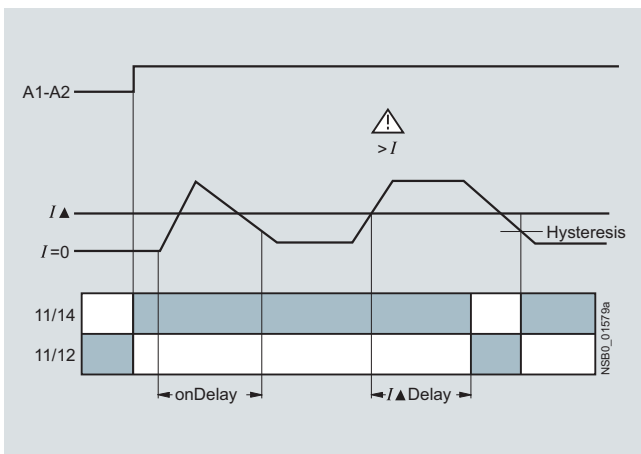

Current undershoot

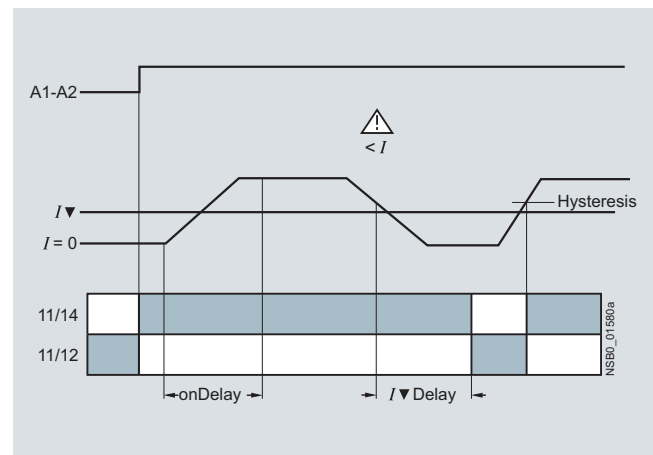

Window monitoring

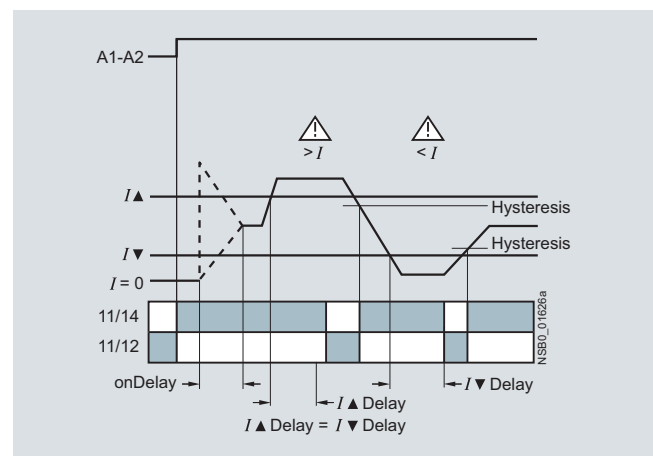



Monitoring Relays

3UG Monitoring Relays for Electrical and Additional Measurements

Current monitoring

Technical specifications

		3UG46 21-AA	3UG46 21-AW	3UG46 22-AA	3UG46 22-AW
General data					
Rated control supply voltage U_s	V	24	24 ... 240	24	24 ... 240
Rated frequency	Hz	50/60			
Operating range	V	20.4 ... 26.4	20.4 ... 264	20.4 ... 26.4	20.4 ... 264
Rated power	W/VA	2/4			
Width	mm	22.5			
RESET		Automatic/manual			
Availability time after application of U_s	ms	1000			
Response time once a switching threshold is reached	ms	Max. 450			
Adjustable tripping delay time/ON-delay time	s	0.1 ... 20			
Mains buffering time, minimum	ms	10			
Rated insulation voltage U_i Degree of pollution 3; overvoltage category III acc. to IEC 60664	V	690			
Rated impulse withstand voltage U_{imp}	kV	6			
Protective separation acc. to IEC 60947-1, Annex N	V	300			
Permissible ambient temperature					
• During operation	°C	-25 ... +60			
• During storage	°C	-40 ... +85			
EMC tests¹⁾		IEC 60947-5-1/IEC 61000-6-2/IEC 61000-6-4			
Degree of protection acc. to IEC 60529		IP40 Enclosure IP20 Terminals			
Mounting position		Any			
Vibration resistance acc. to IEC 60068-2-6		1 ... 6 Hz: 15 mm; 6 ... 500 Hz: 2 g			
Shock resistance acc. to IEC 60068-2-27 for half-sine shock type	g/ms	15/11			
Connection type		 Screw terminals			
• Terminal screw		M 3 (standard screwdriver, size 2 and Pozidriv 2)			
• Solid	mm ²	1 x (0.5 ... 4)/2 x (0.5 ... 2.5)			
• Finely stranded with end sleeve	mm ²	1 x (0.5 ... 2.5)/2 x (0.5 ... 1.5)			
• AWG cables, solid or stranded	AWG	2 x (20 ... 14)			
• Tightening torque	Nm	0.8 ... 1.2			
Connection type		 Spring-type terminals			
• Solid	mm ²	2 x (0.25 ... 1.5)			
• Finely stranded, with end sleeves	mm ²	2 x (0.25 ... 1.5)			
• Finely stranded	mm ²	2 x (0.25 ... 1.5)			
• AWG cables, solid or stranded	AWG	2 x (24 ... 16)			
Measuring circuit					
Measuring range for single-phase AC/DC current	A	0.003 ... 0.6		0.05 ... 15	
Setting range for single-phase current	A	0.003 ... 0.5		0.05 ... 10	
Load supply voltage	V	24	Max. 300 ²⁾ Max. 500 ³⁾	24	Max. 300 ²⁾ Max. 500 ³⁾
Measuring accuracy	%	5			
Repeat accuracy at constant parameters	%	1			
Accuracy of digital display		±1 digit			
Deviations for temperature fluctuations	%/°C	±0.1			
Hysteresis for single-phase current		0.1 ... 250 mA		0.01 ... 5 A	
Permissible overcurrent, continuous	A	0.6		15	
Permissible overcurrent, < 1 s	A	5		50	
Protection against destruction, DIAZED gL/gG	A	2		16	
Measuring circuit internal resistance, shunt	mΩ	500		5	
Control circuit					
Load capacity of the output relay					
• Conventional thermal current I_{th}	A	5			
Rated operational current I_e					
• AC-15 at 24 ... 400 V	A	3			
• DC-13 at 24 V	A	1			
• DC-13 at 125 V	A	0.2			
• DC-13 at 250 V	A	0.1			
Minimum contact load at 17 V DC	mA	5			
Output relay with DIAZED fuse gL/gG	A	4			
Electrical endurance AC-15, 3 A, million operating cycles		0.1			
Endurance with contactor relay million operating cycles		10			

¹⁾ Important: This is a Class A product. In the household environment this device may cause radio interference. In this case the user must introduce suitable measures.

²⁾ With protective separation.

³⁾ With simple separation.

Monitoring Relays

3UG Monitoring Relays for Electrical and Additional Measurements

Current monitoring

Dimensional drawings

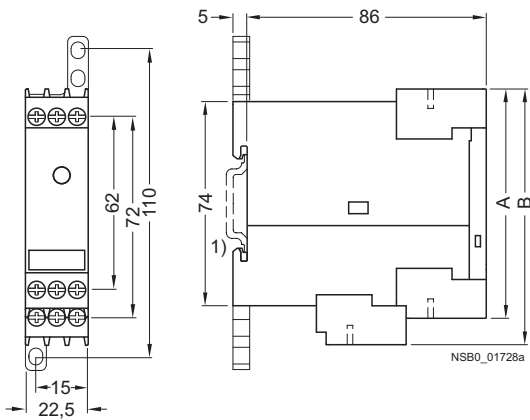

Type	3UG46 21	3UG46 22
	A	B

Removable terminal

Screw-type terminal	83	92
Spring-loaded terminal	84	94

1) For standard mounting rail according to EN 60715.

Schematics

3UG46 21-AA30 3UG46 22-AA30

Operation with separate control circuit and load circuit

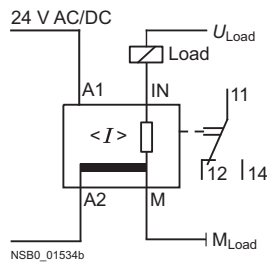

Operation with joint control circuit and load circuit

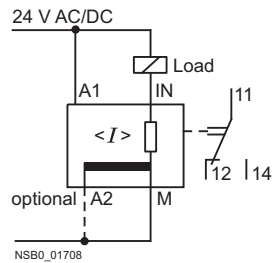

Position of the terminals

3UG46 21 3UG46 22

A1	IN	M
		A2
12	11	14

NSB0_01611

3UG46 21-AW30 3UG46 22-AW30

Single-phase operation

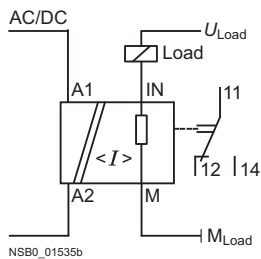

3-phase operation

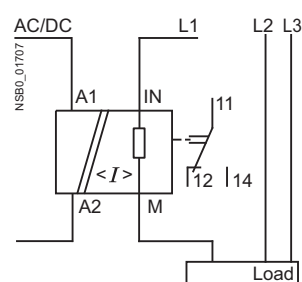

Monitoring Relays

3UG Monitoring Relays for Electrical and Additional Measurements

Current monitoring

Wiring diagram for 24 V AC/DC (only 3UG46 2.-AA30)

From the following circuit diagrams it is clear that loads in measuring circuits have to be in the current flow upstream from the monitoring relay. Otherwise, the monitoring relay could be destroyed and the short-circuit current could cause damage to the plant.

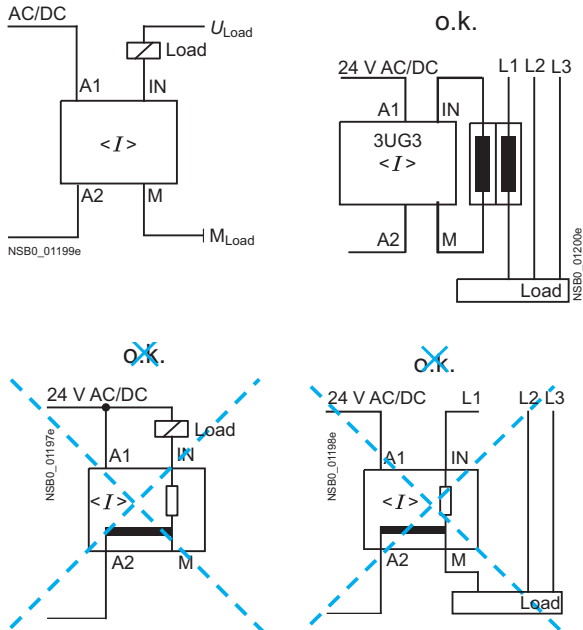

Configuring note:

A2 and M are electrically connected internally!

For applications in which the load to be monitored and the monitoring relay are supplied from the same power supply, there is no need for connection A2!

The load current must always flow through M or the monitoring relay may be destroyed!

Monitoring Relays

3UG Monitoring Relays for Electrical and Additional Measurements

Power factor and active current monitoring

Overview



The 3UG46 41 power factor and active current monitoring device enables the load monitoring of motors.

Whereas power factor monitoring is used above all for monitoring no-load operation, the active current monitoring option can be used to observe and evaluate the load factor over the entire torque range.

Function

3UG46 41 monitoring relays

The 3UG46 41 monitoring relay is self-powered and serves the single-phase monitoring of the power factor or performs overshoot, undershoot or window monitoring of the active current depending on how it is parameterized.

The load to be monitored is connected in front of the IN terminal. The load current flows over the IN and Ly/N terminals. The setting range for the power factor is 0.1 ... 0.99 and for the active current I_{res} 0.2 ... 10 A.

If the supply voltage is switched on and no load current is flowing, the display indicates $I < 0.2$ and a symbol for overshoot, undershoot or window monitoring.

If the motor is now switched on and the current exceeds 0.2 A, the set ON-delay time begins. During this time, an undershooting or overshooting of the set limit values will not lead to a relay response of the changeover contact.

If the operational flowing active current and/or the power factor value falls below or exceeds the respective set threshold value, the spike delay begins. When this time has expired, the relay changes its switch position. The relevant measured variables for overshooting and undershooting in the display flashes. If the monitoring of active current undershooting is deactivated ($I_{res} \nabla = \text{OFF}$) and the load current drops below the lower measurement range threshold (0.2 A), then the CO contacts remain unchanged. If a threshold value is set for the monitoring of active current undershooting, then undershooting of the measurement range threshold (0.2 A) will result in a response of the CO contacts.

The relay operates either according to the open-circuit or closed-circuit principle.

If the device is set to Auto-RESET (Memory = No), depending on the set principle of operation, the switching relay returns to its initial state and the flashing ends when the hysteresis threshold is reached.

If manual reset is selected in the menu (Memory = Yes), the switching relay remains in its current switching state and the current measured value and the symbol for undershooting and overshooting continues to flash, even when the measured variable reaches a permissible value again. This stored fault status can be reset by pressing the UP▲ and DOWN▼ key simultaneously for 2 seconds, or by switching the supply voltage off and back on again.

With the closed-circuit principle selected

Behavior upon undershooting of the measurement range limit with activated monitoring of $I_{res} \nabla$

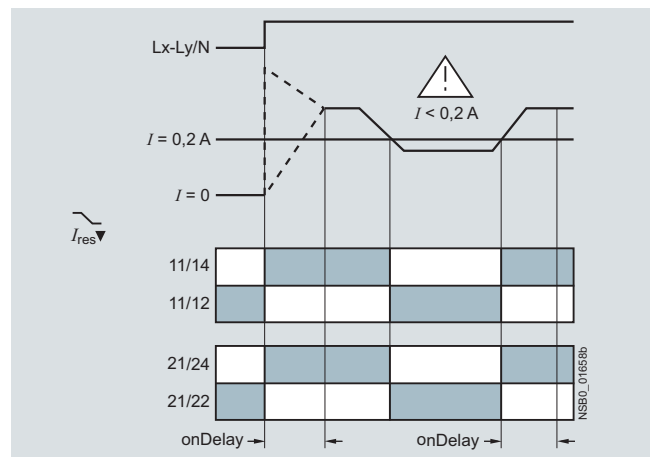

Behavior upon undershooting of the measurement range limit with deactivated monitoring of active current undershooting

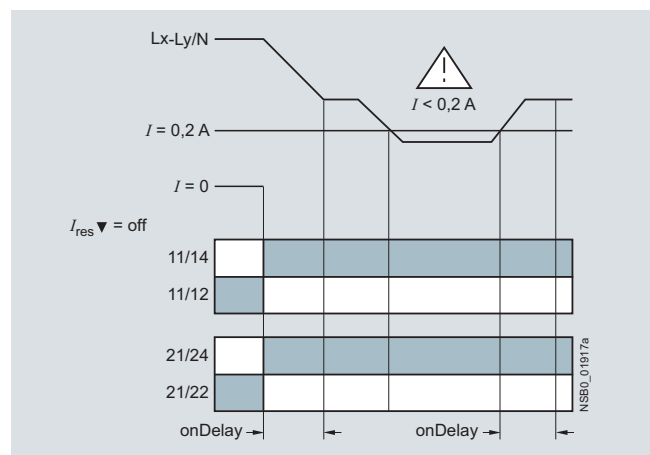

Monitoring Relays

3UG Monitoring Relays for Electrical and Additional Measurements

Power factor and active current monitoring

Overshooting of active current

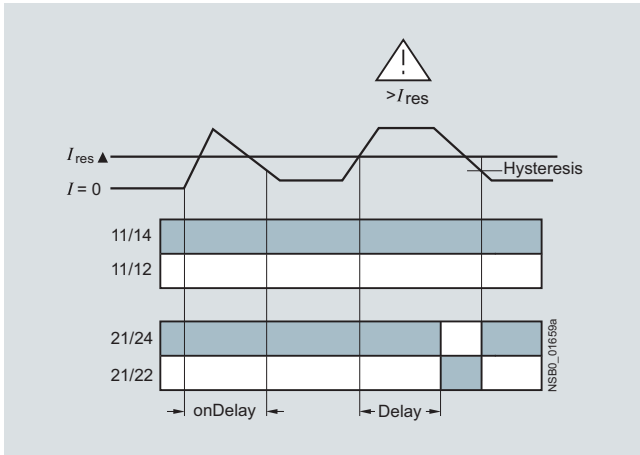

Overshooting of power factor

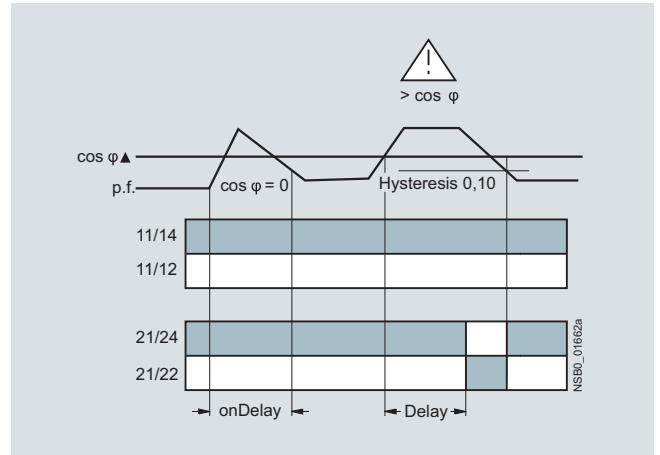

Undershooting of active current

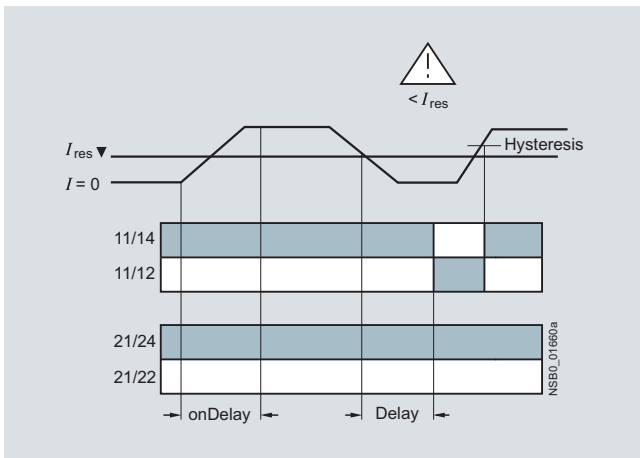

Undershooting of power factor

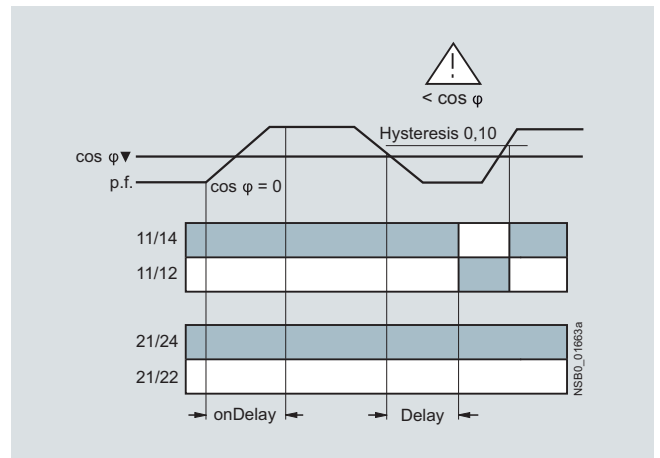

Window monitoring of active current

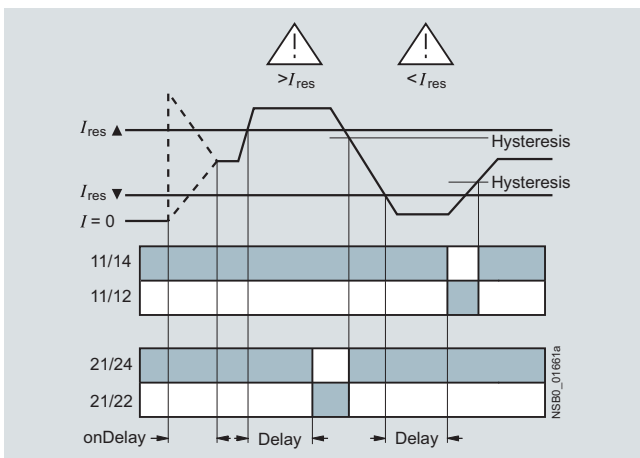

Window monitoring of power factor

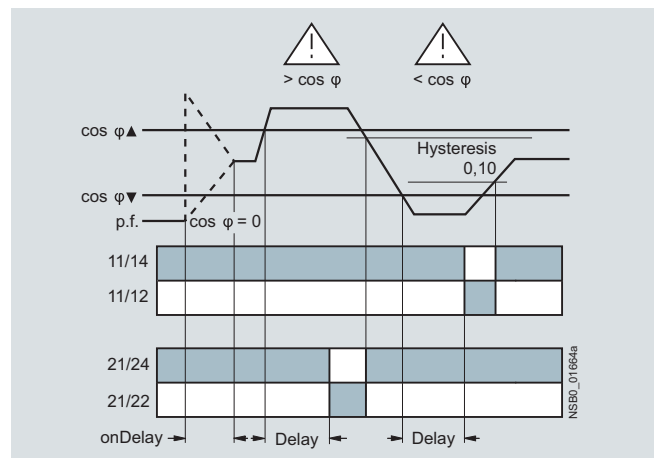

Legend



cos ϕ : p. f.

Monitoring Relays

3UG Monitoring Relays for Electrical and Additional Measurements

Power factor and active current monitoring

Technical specifications

Type	3UG46 41	
General data		
Rated control supply voltage U_g	V	90 ... 690
Absolute limit values		
Rated frequency	Hz	50/60
Rated power, typical		
• At 200 V AC	VA	2.0
• At 400 V AC	VA	2.7
• At 460 V AC	VA	3.1
Width	mm	22.5
RESET	Automatic/manual	
Principle of operation	Closed-circuit principle, open-circuit principle	
Availability time after application of U_g	ms	1000
Response time once a switching threshold is reached	ms	Max. 450
Adjustable tripping delay time	s	0.1 ... 20
Adjustable ON-delay time	s	0 ... 99
Mains buffering time, minimum	ms	10
Rated insulation voltage U_i	V	690
Degree of pollution 3 Overvoltage category III acc. to IEC 60664		
Rated impulse withstand voltage	kV	6
Permissible ambient temperature		
• During operation	°C	-25 ... +60
• During storage	°C	-40 ... +85
EMC tests¹⁾	IEC 60947-5-1/IEC 61000-6-2/IEC 61000-6-4	
Degree of protection acc. to IEC 60529	IP40 Enclosure IP20 Terminals	
Mounting position	Any	
Vibration resistance acc. to IEC 60068-2-6	1 ... 6 Hz: 15 mm; 6 ... 500 Hz: 2 g	
Shock resistance acc. to IEC 60068-2-27	g/ms	15/11
Connection type	 Screw terminals	
• Terminal screw		M 3 (standard screwdriver, size 2 and Pozidriv 2)
• Solid	mm ²	1 x (0.5 ... 4)/2 x (0.5 ... 2.5)
• Finely stranded with end sleeve	mm ²	1 x (0.5 ... 2.5)/2 x (0.5 ... 1.5)
• AWG cables, solid or stranded	AWG	2 x (20 ... 14)
• Tightening torque	Nm	0.8 ... 1.2
Connection type	 Spring-type terminals	
• Solid	mm ²	2 x (0.25 ... 1.5)
• Finely stranded, with end sleeves	mm ²	2 x (0.25 ... 1.5)
• Finely stranded	mm ²	2 x (0.25 ... 1.5)
• AWG cables, solid or stranded	AWG	2 x (24 ... 16)
Measuring circuit		
Measurable active current I_{res}	A	0.2 ... 10
Max. permissible load current	A	10
Peak current < 1 s	A	50
Adjustable response value		0.1 ... 0.99
Phase displacement angle		
DIAZED protection, gL/gG operational class	A	16
Measuring accuracy	%	10
Repeat accuracy at constant parameters	%	1
Accuracy of digital display		± 1 digit
Deviations for temperature fluctuations	%/°C	±0.1
Hysteresis		0.10
Phase angle		
Hysteresis	A	0.1 ... 2.0
Active current monitoring		

¹⁾ Important: This is a Class A product. In the household environment this device may cause radio interference. In this case the user must introduce suitable measures.

Monitoring Relays

3UG Monitoring Relays for Electrical and Additional Measurements

Power factor and active current monitoring

Type	3UG46 41	
Control circuit		
Number of CO contacts for auxiliary contacts		2
Load capacity of the output relay		
• Conventional thermal current I_{th}	A	5
Rated operational current I_e at		
• AC-15 at 24 ... 400 V	A	3
• DC-13 at 24 V	A	1
• DC-13 at 125 V	A	0.2
• DC-13 at 250 V	A	0.1
Minimum contact load at 17 V DC	mA	5
Output relay with DIAZED fuse gL/gG operational class	A	4
Electrical endurance AC-15	Million operating cycles	0.1
Mechanical endurance	Million operating cycles	10

Dimensional drawings

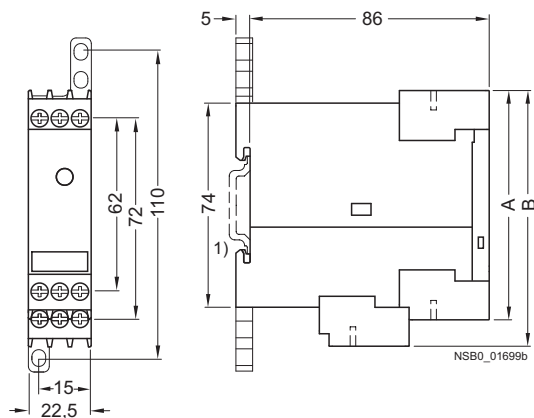

Type	3UG46 41	
	A	B

Removable terminal

Screw-type terminal	83	92
Spring-loaded terminal	84	94

1) For standard mounting rail according to EN 60715.

Monitoring Relays

3UG Monitoring Relays for Electrical and Additional Measurements

Power factor and active current monitoring

Schematics

Single-phase motors

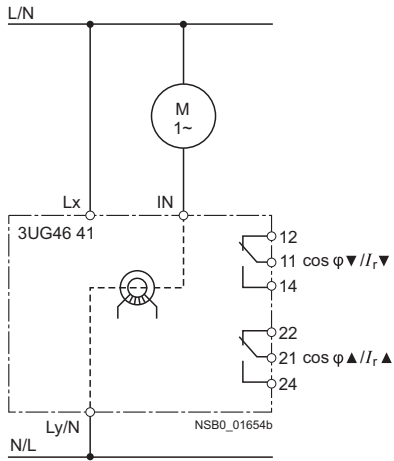

3-phase motors

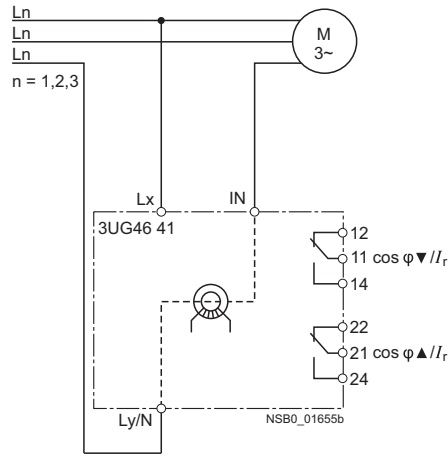

3-phase motors with transformers for currents > 10 A

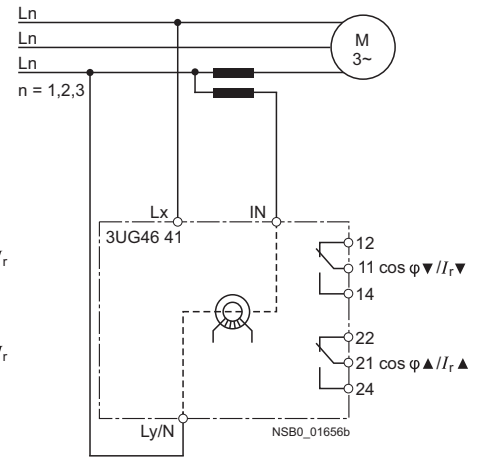

Legend

$\cos \varphi$: p. f.

Position of the terminals

3UG46 41

Lx	Ly/N	IN
12	11	14
22	21	24

NSB0_01657

Monitoring Relays

3UG Monitoring Relays for Electrical and Additional Measurements

Residual current monitoring: Residual-current monitoring relays

Overview



The 3UG46 24 residual current monitoring relay is used together with the 3UL22 summation current transformer for plant monitoring.

Function

3UG46 24 monitoring relays

The main conductor and any neutral conductor to which a load is connected, are routed through the opening of the annular strip-wound core of a summation current transformer. A secondary winding is placed around this annular strip-wound core to which the monitoring relay is connected.

If operation of a plant is fault-free, the sum of the inflowing and outward currents equals zero. In this case, no voltage is induced in the secondary winding of the summation current transformer.

However, if an insulation fault occurs downstream of the residual current operated circuit breaker, the sum of the inflowing currents is greater than that of the outward currents.

The differential current - the residual current - induces a secondary current in the secondary winding of the transformer. This current is evaluated in the monitoring relay and is used on the one hand to display the actual residual current and on the other, to switch the relay if the set warning or tripping threshold is overshoot.

If the measured residual current exceeds the set warning value, the associated changeover contact instantly changes the switching state and an indication appears on the display. If the measured residual current exceeds the set tripping value, the set delay time begins and the associated relay symbol flashes. On expiry of this time, the associated changeover contact changes the switching state.

ON-delay time for motor start

To be able to start a motor, once the auxiliary voltage has been applied for an adjustable ON-delay time, and depending on whether the open-circuit or closed-circuit principle is selected, the output relay switches to the GO state.

The changeover contacts do not react if the set threshold value is overshoot during this period.

Monitoring Relays

3UG Monitoring Relays for Electrical and Additional Measurements

Residual current monitoring: Residual-current monitoring relays

With the closed-circuit principle selected

Residual current monitoring with Auto-RESET (Memory = no)

If the device is set to Auto-RESET (Memory = No), the relay switches for the tripping value once the value falls below the set hysteresis threshold and the display stops flashing. The associated relay changes its switching state if the value falls below the fixed hysteresis value of 5 % of the warning value. Any overshoots are therefore not stored.

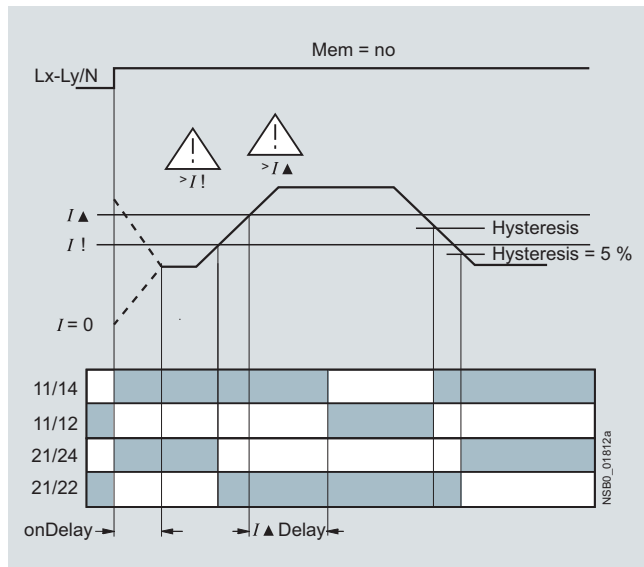

Note:

The neutral conductor must not be grounded downstream of the summation current transformer as this may impair the function of the residual current monitoring device.

Residual current monitoring with Manual-RESET (Memory = yes)

If Manual-RESET is selected in the menu, the output relay remains in its current switching state and the current measured value and the symbol for overshooting continues to flash, even when the measured residual current returns to a permissible value. This stored fault status can be reset by pressing the UP▲ and DOWN▼ key simultaneously for > 2 seconds, or by switching the supply voltage off and back on again.

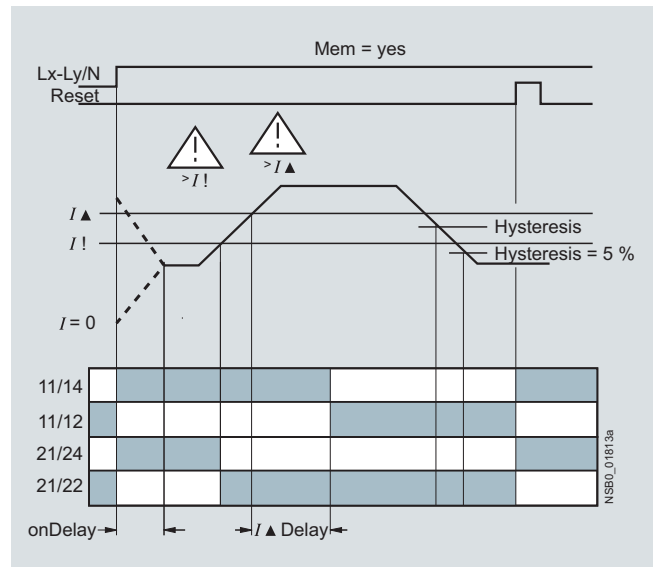



Monitoring Relays

3UG Monitoring Relays for Electrical and Additional Measurements

Residual current monitoring: Residual-current monitoring relays

Technical specifications

Type	3UG46 24	
General data		
Rated control supply voltage U_s	V	90 ... 690
Absolute limit values		
Rated frequency	Hz	50/60
Rated power , typical		
• At 90 V AC	VA	2.8
• At 230 V AC	VA	2.4
• At 400 V AC	VA	3.1
• At 460 V AC	VA	3.2
• At 690 V AC	VA	4.7
Width	mm	22.5
RESET	Automatic/manual	
Principle of operation	Closed-circuit principle, open-circuit principle	
Availability time after application of U_s	ms	1000
Response time once a switching threshold is reached	ms	Max. 300
Adjustable delay time	s	0.1... 20
Mains buffering time , minimum	ms	10
Rated insulation voltage U_i	V	690
Degree of pollution 3 Overvoltage category III acc. to IEC 60664		
Rated impulse withstand voltage	kV	6
Permissible ambient temperature		
• During operation	°C	-25 ... +60
• During storage	°C	-40 ... +85
EMC tests ¹⁾	IEC 60947-5-1/IEC 61000-6-2/IEC 61000-6-4	
Degree of protection acc. to IEC 60529	IP40 Enclosure IP20 Terminals	
Mounting position	Any	
Vibration resistance acc. to IEC 60068-2-6	1 ... 6 Hz: 15 mm; 6 ... 500 Hz: 2 g	
Shock resistance acc. to IEC 60068-2-27	g/ms	15/11
Connection type	 Screw terminals	
• Terminal screw		M3 (for standard screw driver size 2 and Pozidriv 2)
• Solid	mm ²	1 x (0.5 ... 4)/2 x (0.5 ... 2.5)
• Finely stranded with end sleeve	mm ²	1 x (0.5 ... 2.5)/2 x (0.5 ... 1.5)
• AWG cables, solid or stranded	AWG	2 x (20 ... 14)
• Tightening torque	NM	0.8 ... 1.2
Connection type	 Spring-type terminals	
• Solid	mm ²	2 x (0.25 ... 1.5)
• Finely stranded, with end sleeves	mm ²	2 x (0.25 ... 1.5)
• Finely stranded	mm ²	2 x (0.25 ... 1.5)
• AWG cables, solid or stranded	AWG	2 x (24 ... 16)
Measuring circuit		
Measurable residual current I_{res}	A	10 ... 120 % $I_{\Delta n}$ ($I_{\Delta n}$: rated residual current of the transformer)
Adjustable response value		
• Residual current		10 ... 100 % $I_{\Delta n}$
• Warning		10 ... 100 % $I_{\Delta n}$
Measuring accuracy ³⁾	%	±5
Repeat accuracy at constant parameters	%	±1
Accuracy of digital display		± 1 digit
Deviations for temperature changes	%/°C	±0.1
Hysteresis for residual current		LSB ²⁾ up to 50 % $I_{\Delta n}$
Hysteresis for warning threshold	A	5 % $I_{\Delta n}$

1) Important: This is a Class A product. In the household environment this device may cause radio interference. In this case the user must take suitable precautions.

2) LSB: Smallest adjustable value, transformer-dependent, ≤ 1 % of $I_{\Delta n}$.

3) The measuring accuracy of the evaluation system has higher tolerances when combined with the 3UL2 current transformer.

Monitoring Relays

3UG Monitoring Relays for Electrical and Additional Measurements

Residual current monitoring:
Residual-current monitoring relays

Type	3UG46 24	
Control circuit		
Number of CO contacts for auxiliary contacts	2	
Load capacity of the output relay		
Conventional thermal current I_{th}	A	5
Rated operational current I_e at		
• AC-15 at 24 ... 400 V	A	3
• DC-13 at 24 V	A	1
• DC-13 at 125 V	A	0.2
• DC-13 at 250 V	A	0.1
Minimum contact load at 17 V DC	mA	5
Output relay with DIAZED fuse gL/gG operational class	A	4
Electrical endurance AC-15	Million operating cycles	0.1
Mechanical endurance	Million operating cycles	10

Dimensional drawings

3UG46 24

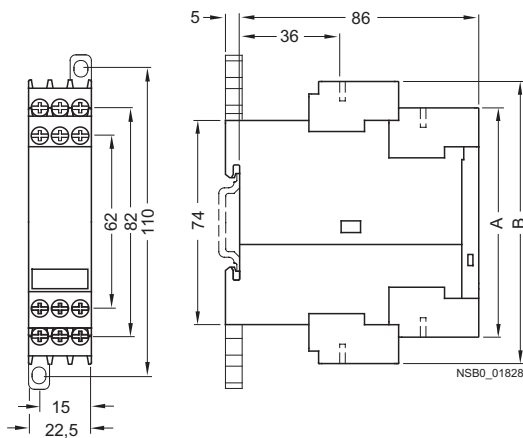

Type	3UG46 24	
	A	B

Removable terminal

Screw-type terminal	83	102
Spring-loaded terminal	84	103

1) For standard mounting rail according to EN 60715.

Monitoring Relays

3UG Monitoring Relays for Electrical and Additional Measurements

Residual current monitoring: Residual-current monitoring relays

Schematics

3UG46 24

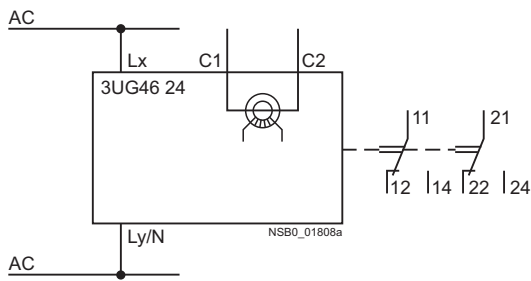

Position of the terminals

	C1	C2
Lx	Ly/N	
12	11	14
22	21	24

NSB0_01825

Note: It is not necessary to protect the measuring circuit for device protection. The protective device for line protection depends on the cross-section used.

Circuit example

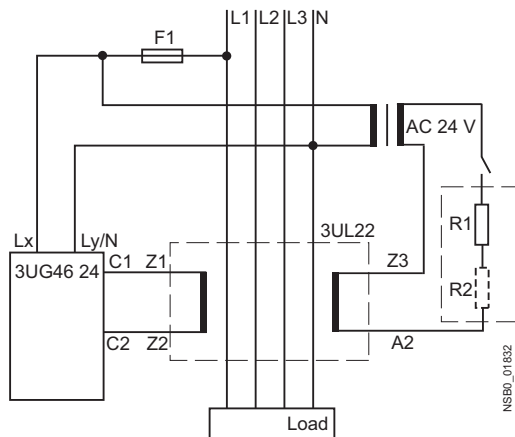

Type	$I_{\Delta n}$	R1	R2
3UL22 0.-1A	0,3 A	220 $\Omega \geq 3$ W	--
3UL22 0.-2A	0,5 A		
3UL22 0.-3A	1 A		
3UL22 0.-1B	6 A	22 $\Omega \geq 6$ W	22 $\Omega \geq 6$ W
3UL22 0.-2B	10 A		
3UL22 0.-3B	16 A		
3UL22 0.-4B	25 A		
3UL22 0.-5B	40 A		

Monitoring Relays

3UG Monitoring Relays for Electrical and Additional Measurements

Residual current monitoring:
3UL22 summation current transformers

Overview

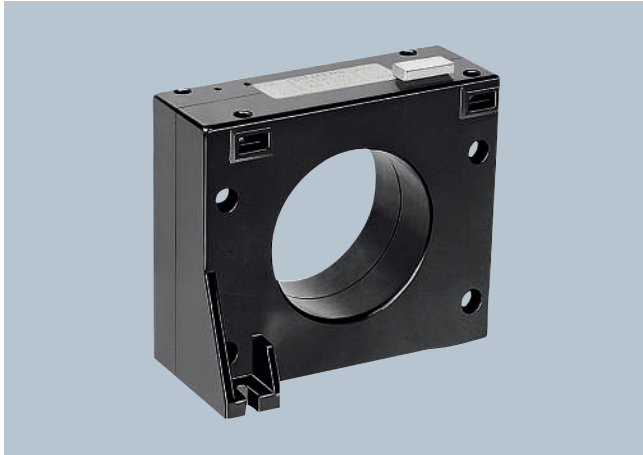

The 3UL22 summation current transformers detect fault currents in machines and plants. Together with the 3UG46 24 residual current monitoring relay or the SIMOCODE 3UF motor management and control device they enable residual-current and ground-fault monitoring.

Technical specifications

Summation current transformers

Type		3UL22 01	3UL22 02	3UL22 03
Rated insulation voltage U_i	AC 50/60 Hz	690 V		1000 V
Rated residual current $I_{\Delta n}$ Without response delay	A	0.3 ... 1	0.3 ... 40	0.3 ... 40
Permissible ambient temperature	°C	-20 ... +70		
Feed-through openings	mm	40	65	120
For Protodur cables Can be fed through	Max. mm ²	4 x 95	4 x 240	8 x 300

Dimensional drawings

3UL22 summation current transformer

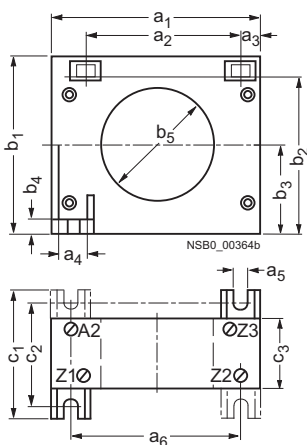

Type	a ₁	a ₂	a ₃	a ₄	a ₅	a ₆	b ₁	b ₂	b ₃	b ₄	b ₅	c ₁	c ₂	c ₃
3UL22 01	100	75	10	15	for M4	80	85	72.5	42.5	7.5	40	65	50	40
3UL22 02	125	95	10	15	for M4	100	110	97.5	55	7.5	65	70	60	45
3UL22 03	200	165	20	20	for M4	170	200	100	100	10	120	85	70	55

Monitoring Relays

3UG Monitoring Relays for Electrical and Additional Measurements

Insulation monitoring
For ungrounded AC networks

Overview



Relay for monitoring the insulation resistance between the ungrounded single or three-phase AC supply and a protective conductor

- Measuring principle with superimposed DC voltage
- Two selectable measuring ranges of 1 ... 110 kΩ
- Stepless setting within the measuring range
- Selectable:
 - Auto reset function with fixed hysteresis or
 - Storage of the tripping operation
- Test function with test button and terminal connections on the front
- Switching output: 1 CO contact
- Insulation fault indication with a red LED
- Supply voltage indication with a green LED
- Electro-magnetically compatible according to IEC 61000-6-2 and IEC 61000-6-4

Function

The monitoring relay measures the insulation resistance between the ungrounded AC supply and an associated protective conductor.

A superposed DC measuring voltage is used to perform the measurement.

The monitoring relay is divided into two ranges for an insulation resistance range from 1 ... 100 kΩ. A range switch on the front can be used to switch over between a 1 ... 11 kΩ range and a 10 ... 110 kΩ range. Within the selected range, the monitoring relay can be steplessly adapted to the respective insulation conditions.

If the insulation resistance undershoots the set response value, the output relay is excited and the red LED (fault indication) is lit.

If the insulation resistance exceeds 1.6 times (corresponding to 60 % hysteresis) the set response value, the output relay will return to the rest position.

Test functions

The "Test" button on the front can be used to simulate a ground fault. If the "Test" button is pressed for at least 300 ms, the output relay is energized and the fault LED lights up. An external test button, which is connected to PE, can also be connected to terminal Y1. The function is activated by closing (> 300 ms).

Fault storage and RESET

If terminals Y1 and Y2 are jumpered, the monitoring relay is set to fault storage mode. If the set insulation resistance is undershot, the output relay is excited and remains tripped even after the insulation resistance rises above 1.6 times the set value again. Fault storage can be reset by briefly pressing the RESET button, briefly jumpering (< 300 ms) the Y1 and PE/ground terminals or by switching off and on the supply voltage.

Note:

The monitoring relay is designed for AC voltage systems. Series-connected rectifiers must be electrically isolated from the measuring relay.

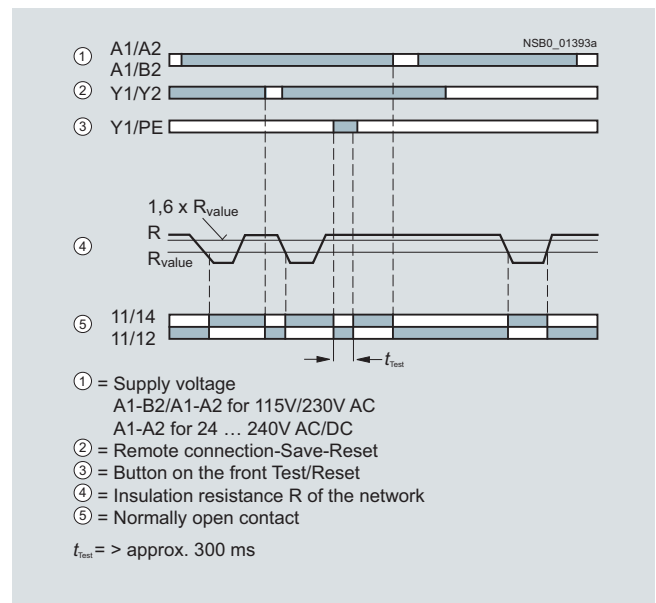

Monitoring Relays

3UG Monitoring Relays for Electrical and Additional Measurements

Insulation monitoring
For ungrounded AC networks

Technical specifications

			3UG30 81
Control circuit			
Operating range of the control supply voltage			-15 %... +10 %
Rated power	24 ... 240 V AC/DC	VA/W	8/2
	110 ... 130 V AC/DC	VA	3
	220 ... 240 V AC/DC	VA	3
Frequency of the rated control supply voltage			Hz 50 ... 60
Measuring circuit L/PE			
• Response value		kΩ	1...110
• Min. internal resistance for AC		kΩ	100
• Min. internal resistance for DC		kΩ	100
• Measurement DC voltage		V	30
• Max. AC insulation voltage (L/PE)		V	415
• Reset/test function terminals (max. 10 m)			Y1-Y2
• Delay time in case of response		s	1
Output relay			1 CO contact, open-circuit principle
General data			
Rated insulation voltage U_i	Between supply, measurement, and output circuit	V	250 acc. to IEC 60947-1
Overvoltage category	Acc. to EN 60664-1		III
Degree of pollution	Acc. to IEC 60664-1		3
Impulse withstand voltage U_{imp}	Acc. to VDE 0435, Part 303	kV	4
Degree of protection	Acc. to IEC 60529		IP50 enclosure IP20 terminals
Shock resistance	Acc. to IEC 60068-2-27	g/ms	10
Vibration resistance	Acc. to IEC 60068-2-6		10 ... 55 Hz: 0.35 mm
Permissible ambient temperature			
• During operation		°C	-25 ... 65
• During storage		°C	-40 ... 85
Mounting position			Any
Conductor cross-section	Solid	mm ²	2 x 0.75 ... 2.5
	Finely stranded with end sleeve	mm ²	2 x 0.75 ... 2.5

Dimensional drawings

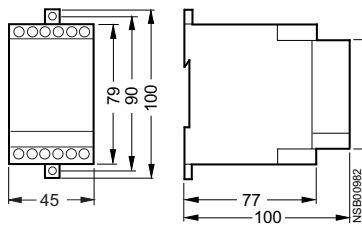

Schematics

Circuit diagram for networks up to 400 V AC

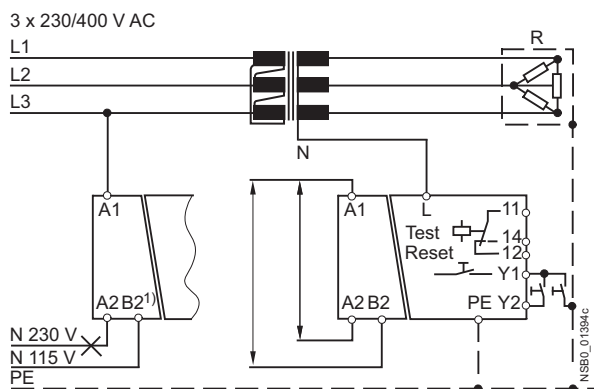

A1-A2 for 24...240 V AC/DC

A1-B2 for 115 V AC or
A1-B2 for 230 V AC
1) Only 3UG3081-1AK20.

Monitoring Relays

3UG Monitoring Relays for Electrical and Additional Measurements

Insulation monitoring
For ungrounded DC networks

Overview



Relay for monitoring the insulation resistance between ungrounded pure DC networks and a protective conductor

- Measuring principle for residual current measurement
- Response value can be adjusted steplessly from 10 ... 110 kΩ
- Selectable
 - Auto reset function with hysteresis or
 - Storage of the tripping operation
- Front selector switch for open-circuit and closed-circuit principle for the output relay
- Test function with test buttons on the front for L+ and L- and over terminal connections
- Switching output: 1 CO contact
- Insulation fault indicator for L+ and L- through two red LEDs
- Supply voltage indication with a green LED
- Electro-magnetically compatible according to IEC 61000-6-2 and IEC 61000-6-4

Function

The monitoring relay measures the insulation resistance between the positive and negative supply voltage in an ungrounded DC voltage network and a corresponding protective conductor.

The measurement is based on the DC residual current measurement principle. The response value can be adjusted steplessly in the range from 10 ... 110 kΩ and thus can be adapted to the corresponding conditions. If the insulation resistance falls below the set response value, the output relay triggers (depending on the setting of the open/closed-circuit principle selector switch) and a fault LED lights up.

A ground fault is evaluated separately for L+ and L- and indicated by means of a corresponding LED.

Note:

Due to the measurement principle, a symmetrical ground fault on terminals L+ and L- cannot be evaluated.

Test function

A ground fault can be simulated using the Test L+ and Test L- buttons on the front. If the test button is pressed for at least 1 s, the status of the output relay changes and the corresponding fault LED lights up.

An external test button can be connected to terminals Y1-Y3 for L+ and terminals Y4-Y3 for L-. The function is triggered by means of a NO contact.

Fault storage and RESET

If terminals Y2 and Y3 are linked, the monitoring relay is set to fault storage mode.

If the insulation resistance falls below the set value, the output relay triggers (depending on the setting of the open/closed circuit selector switch), and stays in this state even if the insulation resistance rises again above the hysteresis value (typical: 2 times the set value). This fault storage can be deleted by pressing and releasing the L+ RESET button, opening the Y2-Y3 connection or by switching off the supply voltage.

Open/closed-circuit principle selector switch

The principle of operation of the output relay can be adjusted by means of a selector switch on the front panel.

If the relay is to respond in the event of a fault (contact symbol open), the open-circuit principle must be selected. If the relay however is to trigger in the event of a fault (contact symbol closed), the closed-circuit principle must be selected.

Note:

The position of the selector switch has no effect upon the fault LEDs. The LEDs always light up if the insulation resistance on L+ or L- falls below the set value.

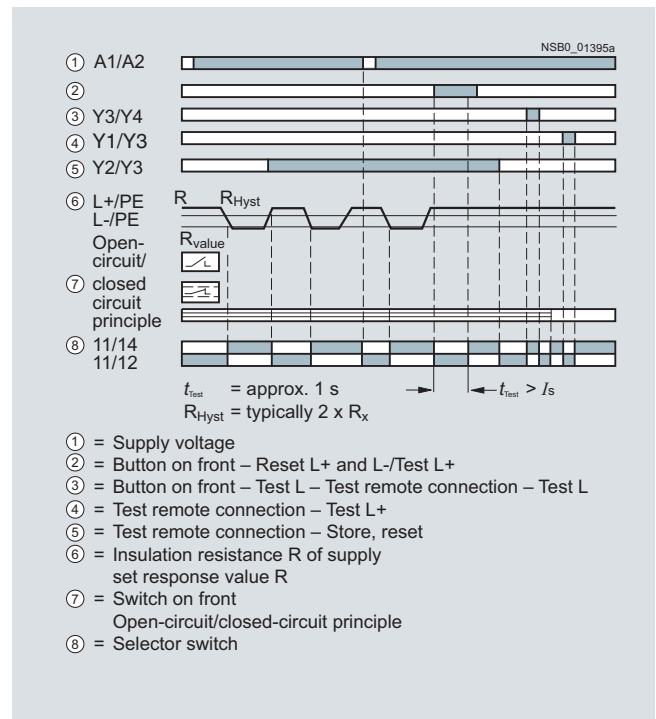

Monitoring Relays

3UG Monitoring Relays for Electrical and Additional Measurements

Insulation monitoring
For ungrounded DC networks

Technical specifications

		3UG30 82	
Control circuit			
Operating range of the control supply voltage		-15 %... +10 %	
Rated power	24 ... 240 V AC/DC	VA/W	8/2
Frequency of the rated control supply voltage		Hz	50 ... 60
Measuring circuit			
• Response value		k Ω	10 ... 110
• Min. internal resistance for DC		k Ω	57
• Measurement DC voltage		V	24 ... 240
• Max. DC insulation voltage (L+/PE/ground, L-/PE/ground)		V	300
• Reset/test function terminals (max. 10 m)			Y1/Y3, Y4/Y3
• Delay time in case of response		s	1
Output relay		1 changeover contact, open-circuit or closed-circuit principle	
General data			
Rated insulation voltage U_i	Between supply, measurement, and output circuit	V	250
Overvoltage category	Acc. to IEC 60664		III
Degree of pollution	Acc. to IEC 60664		3
Impulse withstand voltage U_{imp}	Acc. to VDE 0435, Part 303	kV	4
Degree of protection	Acc. to IEC 60529		IP50 enclosure IP20 terminals
Shock resistance	Acc. to IEC 60068-2-27	g/ms	10
Vibration resistance	Acc. to IEC 60068-2-6		10 ... 55 Hz: 0.35 mm
Permissible ambient temperature		$^{\circ}\text{C}$	$-25 \dots +65$ $-40 \dots +85$
• During operation		$^{\circ}\text{C}$	
• During storage		$^{\circ}\text{C}$	
Mounting position			Any
Conductor cross-section	Solid	mm ²	2 x 0.75 ... 2.5
	Finely stranded with end sleeve	mm ²	2 x 0.75 ... 2.5

Dimensional drawings

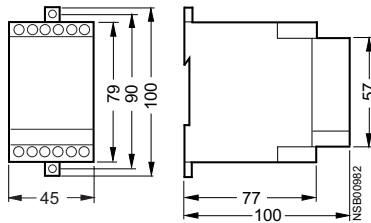

Schematics

Circuit diagram for 24 ... 240 V DC

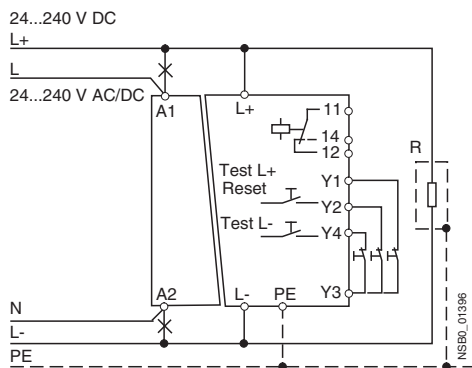

Monitoring Relays

3UG Monitoring Relays for Electrical and Additional Measurements

Level monitoring: Level monitoring relays

Overview



The 3UG45 01 level monitoring relay is used together with 2- or 3-pole sensors to monitor the levels of conductive liquids.

Function

3UG45 01 monitoring relays

The principle of operation of the 3UG45 01 level monitoring relay is based on measuring the electrical resistance of the liquid between two immersion sensors and a reference terminal. If the measured value is lower than the sensitivity set at the front, the output relay changes its switching state. In order to exclude electrolytic phenomena in the liquid, the sensors are supplied with alternating current.

Two-point control

The output relay changes its switching state as soon as the liquid level reaches the maximum sensor, while the minimum sensor is submerged. The relay returns to its original switching state as soon as the minimum sensor no longer has contact with the liquid.

Single-point control

If only one level is being controlled, the terminals for Min and Max on the monitoring relay are bridged. The output relay changes its switching state as soon as the liquid level is reached and returns to its original switching state once the sensor no longer has contact with the liquid.

In order to prevent premature tripping of the switching function caused by wave motion or frothing, even though the set level has not been reached, it is possible to delay this function by 0.5 ... 10 s.

For safe resetting, the supply voltage must be interrupted for at least the set delay time of +0.5 s.

Note:

It is also possible to connect other resistance sensors to the Min and Max terminals in the range 2 ... 200 kW, e. g. photoresistors, temperature sensors, encoders based on resistance etc. The monitoring relay can therefore also be used for other applications apart from monitoring the levels of liquids.

Monitoring Relays

3UG Monitoring Relays for Electrical and Additional Measurements

Level monitoring: Level monitoring relays

OVER, two-point control

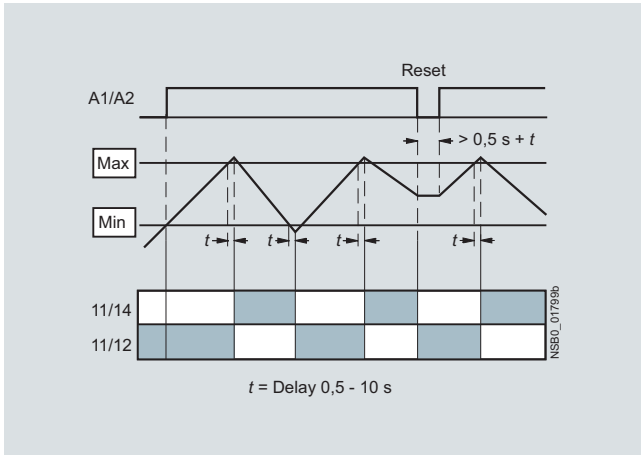

OVER, single-point control

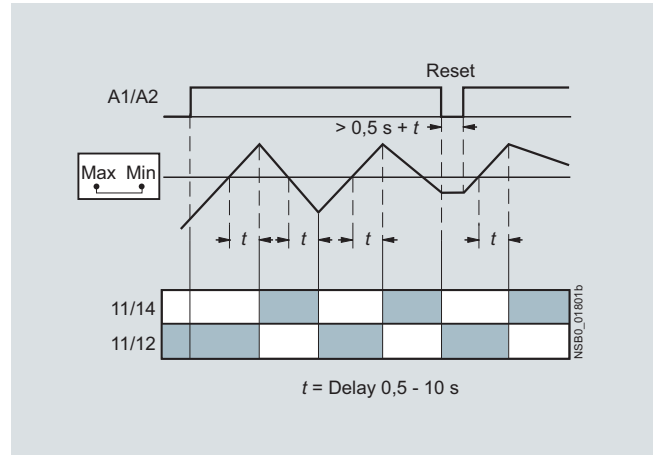

UNDER, two-point control

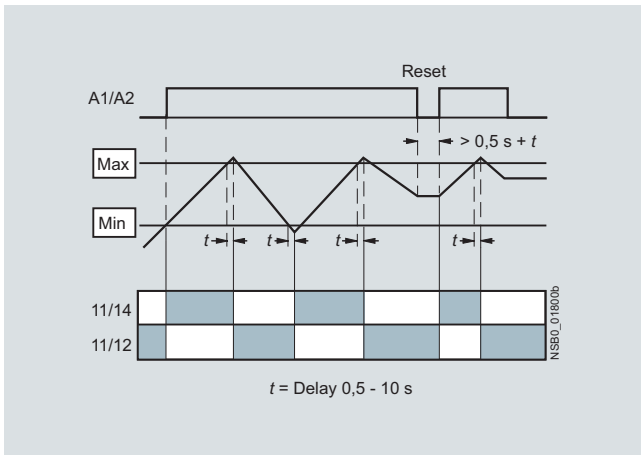

UNDER, single-point control

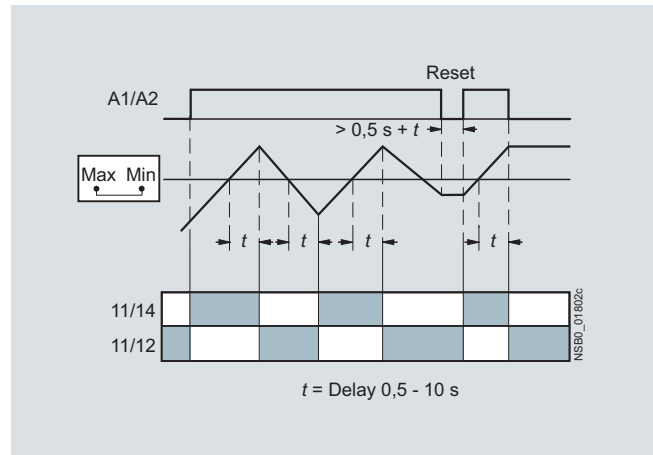



Monitoring Relays

3UG Monitoring Relays for Electrical and Additional Measurements

Level monitoring:
Level monitoring relays

Technical specifications

Type		3UG45 01-1AA30, 3UG45 01-2AA30	3UG45 01-1AW30, 3UG45 01-2AW30
General data			
Rated control supply voltage U_s	V AC/DC	24	24 ... 240
Rated frequency	Hz	50/60	
Operating range	V	20.4 ... 26.4	20.4 ... 264
Rated power, max.			
• At 24 V AC	VA	2	2
• At 240 V AC	VA	--	4
Width	mm	22.5	
Availability time after application of U_s	ms	500	
Response time once a switching threshold is reached	ms	Max. 300	
Adjustable delay time	s	0.5 ... 10	
Inlet or outlet monitoring function		UNDER/OVER selector switch at the front	
Mains buffering time, minimum	ms	200	
Rated insulation voltage U_i	V	300	
Degree of pollution 3, Overvoltage category III acc. to IEC 60664			
Rated impulse withstand voltage	kV	4	
Permissible ambient temperature			
• During operation	°C	-25 ... +60	
• During storage	°C	-40 ... +80	
EMC tests¹⁾		IEC 60947-5-1/IEC 61000-6-2/IEC 61000-6-4	
Degree of protection acc. to IEC 60529		IP40 Enclosure IP20 Terminals	
Mounting position		Any	
Vibration resistance acc. to IEC 60068-2-6		1 ... 6 Hz: 15 mm; 6 ... 500 Hz: 2 g	
Shock resistance acc. to IEC 60068-2-27	g/ms	15/11	
Connection type		 Screw terminals	
• Terminal screw		M3 (for standard screwdriver, size 2 and Pozidriv 2)	
• Solid	mm ²	1 x (0.5 ... 4)/2 x (0.5 ... 2.5)	
• Finely stranded with end sleeve	mm ²	1 x (0.5 ... 2.5)/2 x (0.5 ... 1.5)	
• AWG cables, solid or stranded	AWG	2 x (20 ... 14)	
• Tightening torque	Nm	0.8 ... 1.2	
Connection type		 Spring-type terminals	
• Solid	mm ²	2 x (0.25 ... 1.5)	
• Finely stranded, with end sleeves acc. to DIN 46228	mm ²	2 x (0.25 ... 1.5)	
• Finely stranded	mm ²	2 x (0.25 ... 1.5)	
• AWG cables, solid or stranded	AWG	2 x (24 ... 16)	
Measuring circuit			
Electrode current, max. (typ. 70 Hz)	mA	1	
Electrode voltage, max. (typ. 70 Hz)	V	15	
Sensor feeder cable	m	Max. 100	
Conductor capacity of sensor cable²⁾	nF	Max. 10	
Adjustable sensitivity			
• Resistance	kΩ	2 ... 200	
Measuring accuracy	%	±20	
Repeat accuracy at constant parameters	%	±1	
Deviations for temperature fluctuations	%/°C	±1	
Control circuit			
Number of CO contacts for auxiliary contacts		1	
Load capacity of the output relay			
Conventional thermal current I_{th}	A	5	
Rated operational current I_o at			
• AC-15 at 24 ... 400 V	A	3	
• DC-13 at 24 V	A	1	
• DC-13 at 125 V	A	0.2	
• DC-13 at 250 V	A	0.1	
Minimum contact load at 17 V DC	mA	5	
Output relay with DIAZED fuse	A	4	
gL/gG operational class			
Electrical endurance AC-15, 3 A, million operating cycles		0.1	
Mechanical endurance million operating cycles		10	

¹⁾ Important: This is a Class A product. In the household environment this device may cause radio interference. In this case the user must introduce suitable measures.

²⁾ The sensor cable does not necessarily have to be shielded, but we do not recommend installing this cable parallel to the power supply lines. It is also possible to use a shielded cable, whereby the shield has to be connected to the M terminal.

Monitoring Relays

3UG Monitoring Relays for Electrical and Additional Measurements

Level monitoring:
Level monitoring relays

Dimensional drawings

3UG45 01

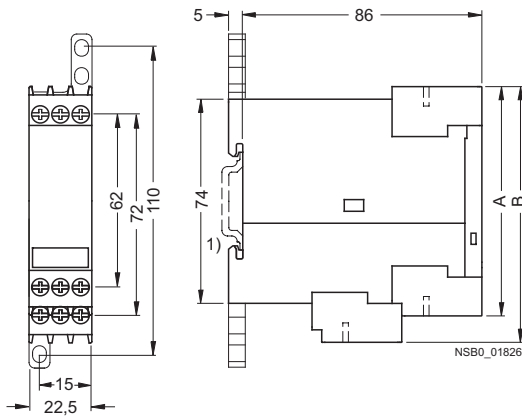

Type	3UG45 01	
	A	B

Removable terminals

Screw terminals	83	92
Spring-loaded terminals	84	94

1) For standard mounting rail according to EN 60715.

Schematics

3UG45 01

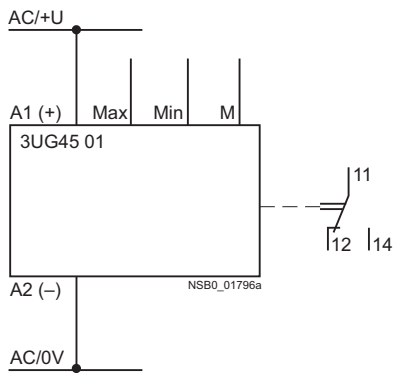

Single-point control with inlet monitoring

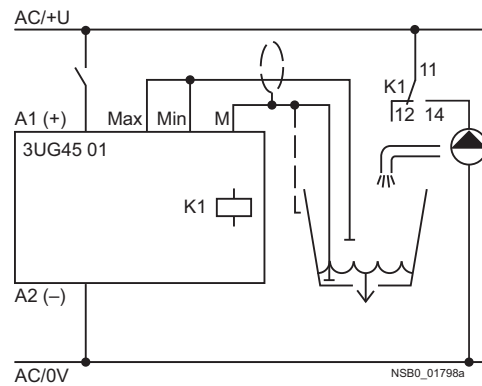

Two-point control with outlet monitoring

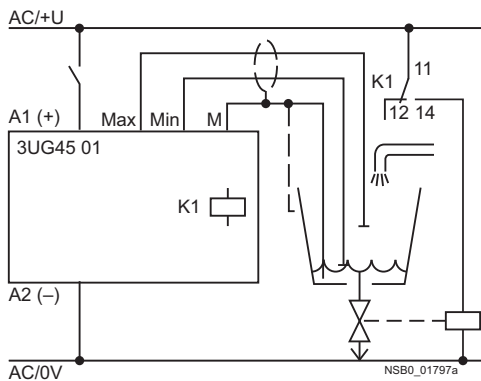

Position of the terminals

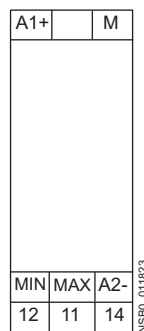

Monitoring Relays

3UG Monitoring Relays for Electrical and Additional Measurements

Level monitoring:
Level monitoring sensors

Technical specifications

Type		3UG32 07-3A three-pole	3UG32 07-2A two-pole	3UG32 07-2B two-pole	3UG32 07-1B single-pole	3UG32 07-1C single-pole
Length	mm	500	500	--	--	--
Insulation	Teflon insulation (PTFE)	Yes	Yes	Yes	--	Yes
Installation		Vertical	Vertical	Lateral	Lateral	Lateral
Screw-in gland width A/F		22				
Thread	inch	R 3/8				
Connecting cable	mm ²	3 x 0.5, 2 m long				
Operating temperature	°C	90				
Operating pressure	bar	10				
Assignment Cable/Electrode	• Cable brown	Center electrode	Not assignable	Gland	Gland	Gland
	• Cable white	Not assignable	Not assignable	Not assignable	Electrode	Electrode
	• Cable green	Not assignable	--	Not assignable	--	--

Dimensional drawings

3UG32 07-3A
three-pole wire electrode

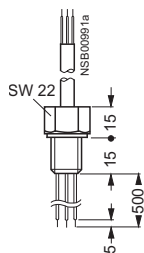

3UG32 07-1B
single-pole bow electrode

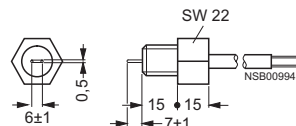

3UG32 07-2A
two-pole wire electrode

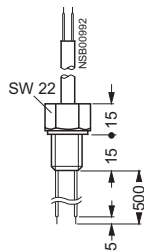

3UG32 07-1C
single-pole electrode, rugged version

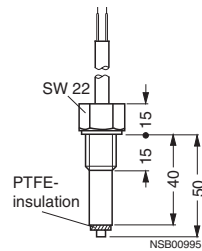

3UG32 07-2B
two-pole bow electrode

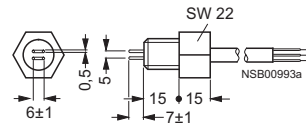

Monitoring Relays

3UG Monitoring Relays for Electrical and Additional Measurements

Speed monitoring

Overview



The 3UG46 51 monitoring relay is used together with a sensor to monitor motor drives for overspeed and/or underspeed.

Furthermore, this relay is ideal for all functions where a continuous pulse signal needs to be monitored (e. g. belt travel monitoring, completeness monitoring, passing monitoring, clock-time monitoring).

Function

3UG46 51 monitoring relays

The speed monitoring relay operates according to the principle of period duration measurement.

In the monitoring relay, the time between two successive rising edges of the pulse encoder is measured and compared to the minimum and/or maximum permissible period duration calculated from the set limit values for the speed.

Thus, the period duration measurement recognizes any deviation in speed after just two pulses, even at very low speeds or in the case of extended pulse gaps.

By using up to ten pulse encoders evenly distributed around the circumference, it is possible to shorten the period duration, and in turn the response time. By taking into account the number of sensors in the monitoring relay, the speed continues to be indicated in rpm.

ON-delay time for motor start

To be able to start a motor drive, and depending on whether the open-circuit or closed-circuit principle is selected, the output relay switches to the GO state during the ON-delay time, even if the speed is still below the set value.

With the closed-circuit principle selected

Window monitoring without enable input

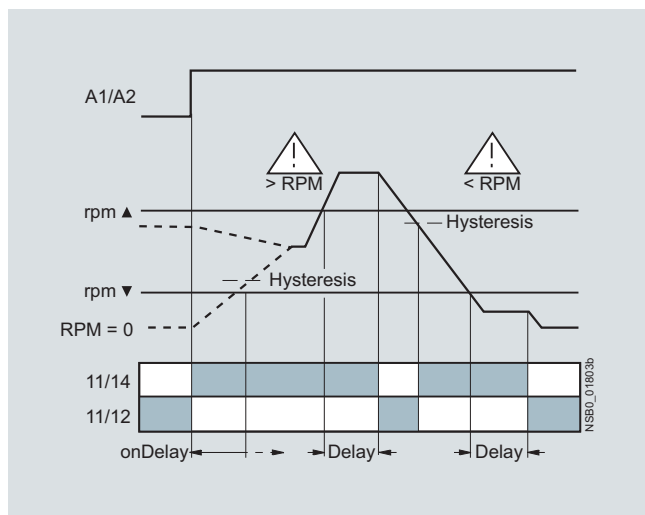

The ON-delay time is started by either switching on the auxiliary voltage or, if the auxiliary voltage is already applied, by actuating the respective NC contact (e. g. auxiliary contact).

Speed monitoring with Auto-RESET (Memory = no)

If the device is set to Auto-RESET, the output relay switches to the GO state, once the adjustable hysteresis threshold is reached in the range of 0.1 ... 99.9 rpm and the flashing stops. Any overshoots or undershoots are therefore not stored.

Speed monitoring with Manual-RESET (Memory = yes)

If Manual-RESET is selected in the menu, the output relay remains in its current switching state and the current measured value and the symbol for overshooting/undershooting continues to flash, even when the speed returns to a permissible value. This stored fault status can be reset by pressing the UP▲ and DOWN▼ buttons simultaneously for > 2 seconds, by connecting the RESET device terminal to 24 V DC or by switching the supply voltage off and back on again.

Window monitoring with enable input

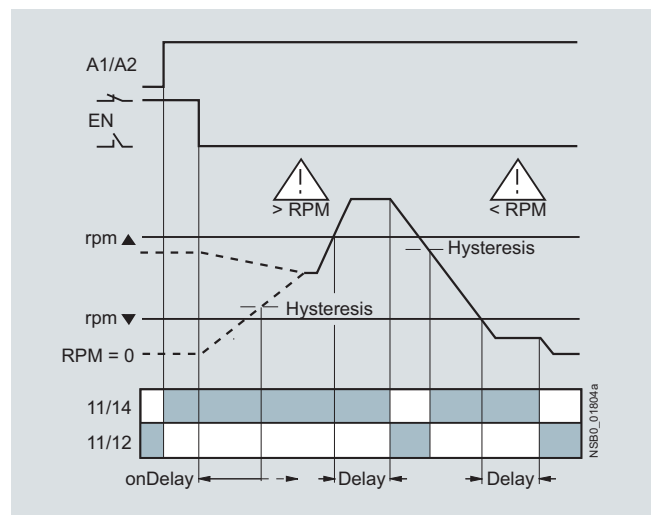



Monitoring Relays

3UG Monitoring Relays for Electrical and Additional Measurements

Speed monitoring

Technical specifications

Type		3UG46 51-1AA30, 3UG46 51-2AA30	3UG46 51-1AW30, 3UG46 51-2AW30
General data			
Rated control supply voltage U_s	V AC/DC	24	24 ... 240
Rated frequency	Hz	50/60	
Operating range	V	20.4 ... 26.4	20.4 ... 264
Rated power, max.			
• At 24 V AC	VA	2.5	4
• At 240 V AC	VA	--	9
Width	mm	22.5	
RESET		Automatic/manual	
Availability time after application of U_s	ms	500	
Response time once a switching threshold is reached	ms	Max. 300	
Adjustable tripping delay time	s	0.1 ... 99.9	
Adjustable ON-delay time	s	1 ... 900	
Principle of operation		Closed-circuit principle, open-circuit principle	
NC/NO contact behavior		Adjustable	
Mains buffering time, minimum	ms	10	
Rated insulation voltage U_i Degree of pollution 3, Overvoltage category III acc. to IEC 60664	V	300	
Rated impulse withstand voltage	kV	4	
Permissible ambient temperature			
• During operation	°C	-25 ... +60 ¹⁾	
• During storage	°C	-40 ... +80	
EMC tests²⁾		IEC 60947-5-1, IEC 61000-6-2, IEC 61000-6-4	
Degree of protection acc. to IEC 60529		IP40 Enclosure IP20 Terminals	
Mounting position		Any	
Vibration resistance acc. to IEC 60068-2-6		1 ... 6 Hz: 15 mm; 6 ... 500 Hz: 2 g	
Shock resistance acc. to IEC 60068-2-27	g/ms	15/11	
Connection type		 Screw terminals	
• Terminal screw		M3 (for standard screwdriver, size 2 and Pozidriv 2)	
• Solid	mm ²	1 x (0.5 ... 4)/2 x (0.5 ... 2.5)	
• Finely stranded with end sleeve	mm ²	1 x (0.5 ... 2.5)/2 x (0.5 ... 1.5)	
• AWG cables, solid or stranded	AWG	2 x (20 ... 14)	
• Tightening torque	Nm	0.8 ... 1.2	
Connection type		 Spring-type terminals	
• Solid	mm ²	2 x (0.25 ... 1.5)	
• Finely stranded, with end sleeves	mm ²	2 x (0.25 ... 1.5)	
• Finely stranded	mm ²	2 x (0.25 ... 1.5)	
• AWG cables, solid or stranded	AWG	2 x (24 ... 16)	
Measuring circuit			
Sensor supply			
• For three-wire sensor (24 V/0 V)	mA	Max. 50	
• For 2-wire NAMUR sensor (8V2)	mA	Max. 8.2	
Signal input			
• IN1	kΩ	16, three-wire sensor, pnp operation	
• IN2	kΩ	1, floating contact, 2-wire NAMUR sensor	
Voltage level			
• For level 1 at IN1	V	4.5 ... 30	
• For level 0 at IN1	V	0 ... 1	
Current level			
• For level 1 at IN2	mA	> 2.1	
• For level 0 at IN2	mA	< 1.2	
Minimum pulse duration of signal	ms	5	
Minimum interval between 2 pulses	ms	5	
Adjustable response value rpm	rpm	0.1 ... 2200	
Hysteresis	rpm	OFF and 0.1 ... 99.9	
Scale		1 ... 10	
Measuring accuracy	%	±10	
Repeat accuracy at constant parameters	%	±1	
Accuracy of digital display		±1 digit	

¹⁾ At a distance of > 1 cm to adjacent devices;
if butt-mounted: +50 °C.

²⁾ Important: This is a Class A product. In the household environment this device may cause radio interference. In this case the user must introduce suitable measures.

Monitoring Relays

3UG Monitoring Relays for Electrical and Additional Measurements

Speed monitoring

Type	3UG46 51-1AA30, 3UG46 51-2AA30	3UG46 51-1AW30, 3UG46 51-2AW30
Control circuit		
Number of CO contacts for auxiliary contacts		1
Load capacity of the output relay		
Conventional thermal current I_{th}	A	5
Rated operational current I_e at		
• AC-15 at 24 ... 400 V AC/DC	A	3
• DC-13 at 24 V	A	1
• DC-13 at 125 V	A	0.2
• DC-13 at 250 V	A	0.1
Minimum contact load at 17 V DC	mA	5
Output relay with DIAZED fuse gL/gG operational class	A	4
Electrical endurance AC-15	Million operating cycles	0.1
Mechanical endurance	Million operating cycles	10

Dimensional drawings

3UG46 51

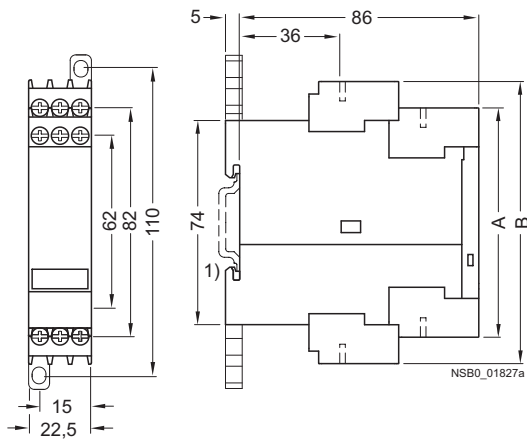

Type	3UG46 51	
	A	B

Removable terminal

Screw-type terminal	83	102
Spring-loaded terminal	84	103

1) For standard mounting rail according to EN 60715.

Monitoring Relays

3UG Monitoring Relays for Electrical and Additional Measurements

Speed monitoring

Schematics

3UG46 51

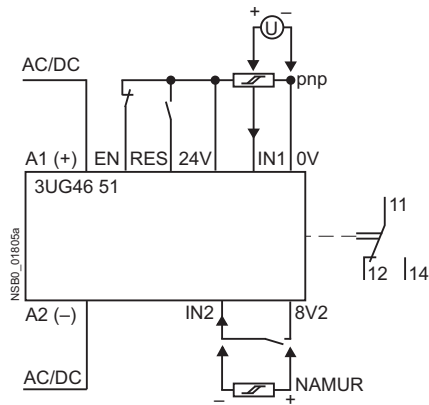

Position of the terminals

24V	IN1	0V
A1+	EN	RES
8V2	IN2	A2-
12	11	14

NSB0_011824

Circuit example without enable input

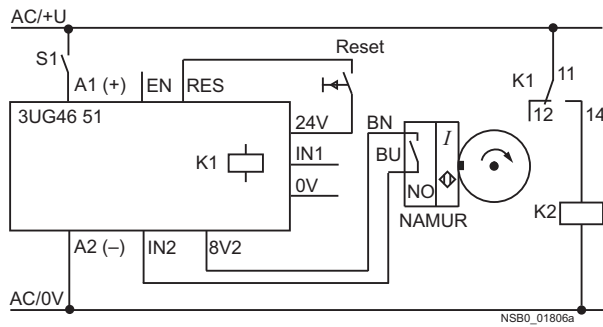

Circuit example with enable input

