

EN 60670-24 **IP66**

QUADRI DA PARETE - CLASSIFICATI "GP" U_o 400V-U_i 1000V~ 1500V=
 SURFACE-MOUNTING DISTRIBUTION ASSEMBLIES
 COFFRET DE DISTRIBUTION MURAUX
 VERTEILERKÄSTEN FÜR WANDMONTAGE
 CUADROS DE DISTRIBUCION DE PARED
 صندوق التوزيع الكهربائي الحائطي

INGRESSI:

CABLE ENTRY:
 ENTREE CABLE:
 KABELINFÜHRUNG:
 ENTRADA DE CABLE:
 مدخل الكابيل

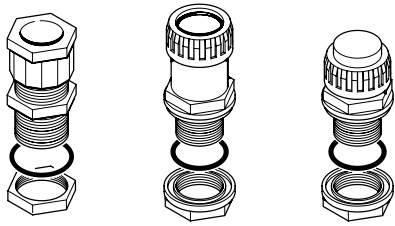

PG13.5
 PG16
 PG21

Articolo Article Article Artikel Articulo بضاعة	Moduli DIN DIN modules Modules DIN DIN Moduln Módulos DIN وحدات DIN	Potenza dissipabile (W) Dissipate heat power (W) Puissance qu'on peut dissiper (W) Wärmeabführvermögen (W) Potencia disipable (W) القوة التي يمكن تبديدها (W)
632.1500-000	4	8W
632.1510-000	4	8W
632.1530-000	4	8W
632.3500-000	6	9W
632.3510-000	6	9W
632.3520-000	6	9W
632.3530-000	6	9W
632.4500-000	11	14W
632.4510-000	11	14W
632.4520-000	11	14W
632.4530-000	11	14W
632.4700-000	11	14W
632.4710-000	11	14W
632.5500-000	14	15W
632.5510-000	14	15W
632.5520-000	14	15W

InfoTECH

<p>ITALY</p> <p>Numero Verde 800-018009</p>	<p>WORLDWIDE</p> <p>ScameOnLine www.scame.com infotech@scame.com</p>
---	--

(**): accetta anche prese 32A con flangia 84x106mm
 (**): also accepts 32A sockets with 84x106mm flange
 (**): accepte également les prises 32A avec une bride de 84x106 mm
 (**): Nimmt auch 32A-Steckdosen mit einem Adapterflansch 84x106mm auf
 (**): también acepta tomas de 32 A con brida de 84x106 mm
 84x106mm مع طوق 32A يقبل ايضا المقابس (**):

BLOCK 1

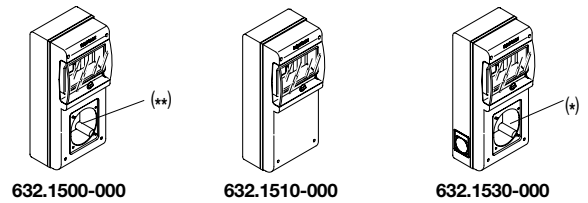

BLOCK 3

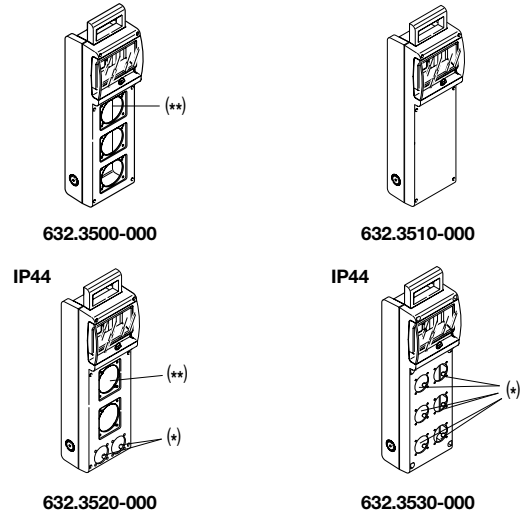

BLOCK 4

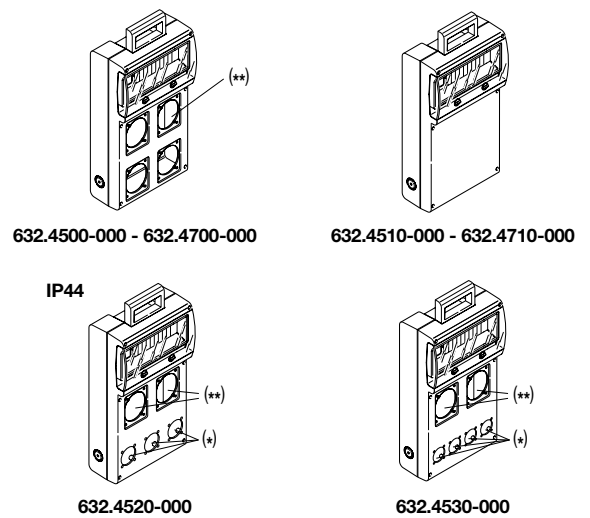

BLOCK 5

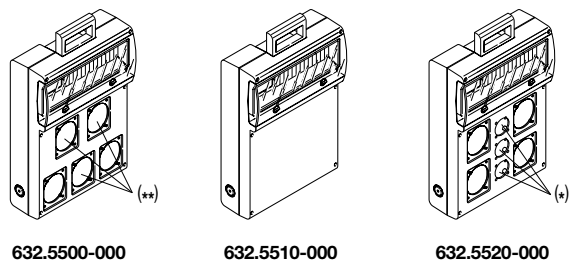

(*): accetta prese domestiche fam. 570
 (*): accepts domestic sockets fam.570
 (*): accepte les prises domestiques de la Série 570.
 (*): Es Akzeptiert die Haushaltssteckdosen von Artikel Serie 570.
 (*): acepta tomas domésticas fam. 570
 fam.570 يقبل المقابس المنزلية (*):

IEC/EN 62208 **IP66**

QUADRI DA PARETE - U_o 400V-U_i 1000V~ 1500V==
 SURFACE-MOUNTING DISTRIBUTION ASSEMBLIES
 COFFRET DE DISTRIBUTION MURAUX
 VERTEILERKÄSTEN FÜR WANDMONTAGE
 CUADROS DE DISTRIBUCION DE PARED
 صندوق التوزيع الكهربائي الحائطي

INGRESSI:

CABLE ENTRY:

ENTREE CABLE:

KABELEINFÜHRUNG:

ENTRADA DE CABLE:

مدخل الكابل

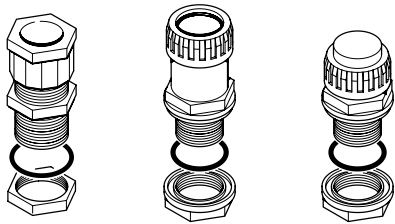

PG13.5
PG16
PG21

Articolo Article Article Artikel Articulo بضاعة	Moduli DIN DIN modules Modules DIN DIN Moduln Módulos DIN وحدات DIN	Potenza dissipabile (W) Dissipate heat power (W) Puissance qu'on peut dissiper (W) Wärmeabführvermögen (W) Potencia disipable (W) القوة التي يمكن تبديدها (W)
632.1500-000	4	8W
632.1510-000	4	8W
632.1530-000	4	8W
632.3500-000	6	9W
632.3510-000	6	9W
632.3520-000	6	9W
632.3530-000	6	9W
632.4500-000	11	14W
632.4510-000	11	14W
632.4520-000	11	14W
632.4530-000	11	14W
632.4700-000	11	14W
632.4710-000	11	14W
632.5500-000	14	15W
632.5510-000	14	15W
632.5520-000	14	15W

BLOCK 1

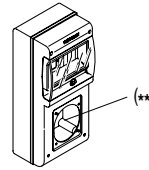

632.1500-000

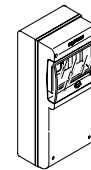

632.1510-000

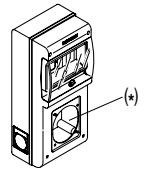

632.1530-000

BLOCK 3

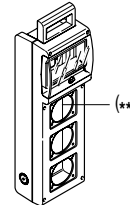

632.3500-000

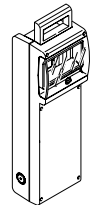

632.3510-000

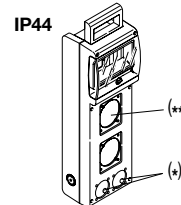

632.3520-000

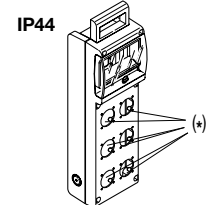

632.3530-000

BLOCK 4

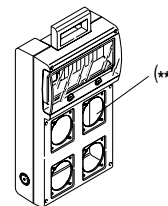

632.4500-000 - 632.4700-000

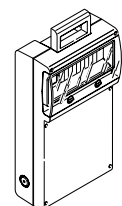

632.4510-000 - 632.4710-000

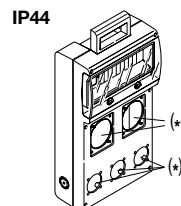

632.4520-000

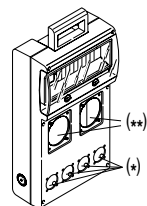

632.4530-000

BLOCK 5

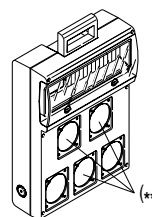

632.5500-000

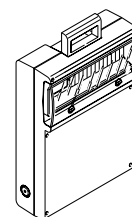

632.5510-000

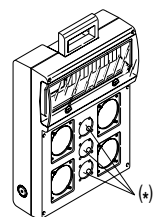

632.5520-000

(**): accetta anche prese 32A con flangia 84x106mm

(**): also accepts 32A sockets with 84x106mm flange

(**): accepte également les prises 32A avec une bride de 84x106 mm

(**): Nimmt auch 32A-Steckdosen mit einem Adapterflansch 84x106mm auf

(**): también acepta tomas de 32 A con brida de 84x106 mm

84x106mm مع طوق 32A يقبل ايضا المقابس 32A (**)

(*): accetta prese domestiche fam. 570

(*): accepts domestic sockets fam.570

(*): accepte les prises domestiques de la Série 570.

(*): Es Akzeptiert die Haushaltssteckdosen von Artikel Serie 570.

(*): acepta tomas domésticas fam. 570

fam.570 يقبل المقابس المنزلية (*)