

Информационен лист | Номер на артикул: 2004-1201

2-conductor through terminal block; 4 mm<sup>2</sup>; suitable for Ex e II applications;  
side and center marking; for DIN-rail 35 x 15 and 35 x 7.5; Push-in CAGE  
CLAMP®; 4,00 mm<sup>2</sup>; gray

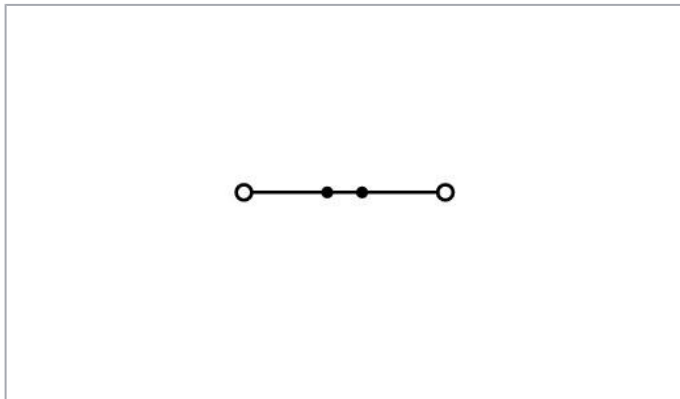
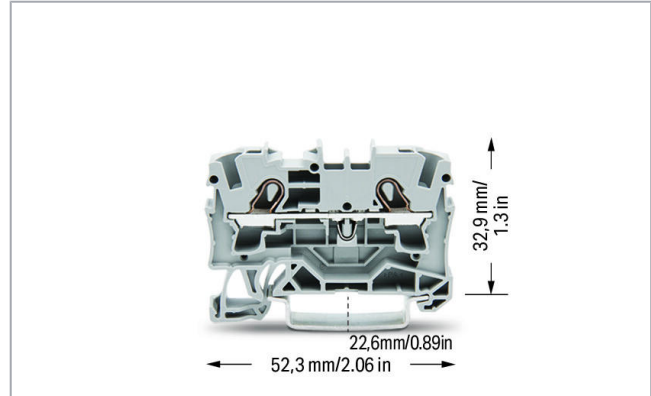
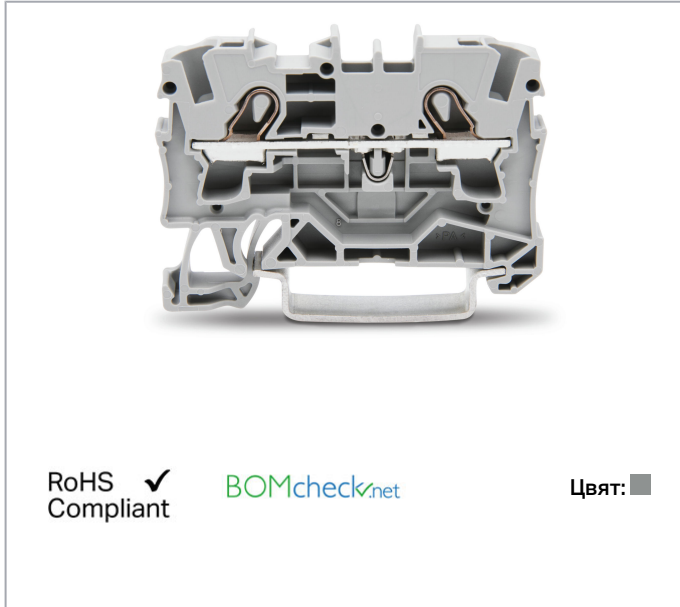

**Данни**  
**Electrical data**

**Ratings per IEC/EN 60664-1**

Ratings per	IEC/EN 60947-7-1
Nominal voltage (III/3)	800 V
Rated surge voltage (III/3)	8 kV
Rated current	32 A

Rated current 2	41 A
Legend (ratings)	(III / 3) $\triangle$ Overvoltage category III / Pollution degree 3

### Ratings per UL 1059

Approvals per	UL 1059
Rated voltage UL (Use Group B)	600 V
Rated current UL (Use Group B)	30 A
Rated voltage UL (Use Group C)	600 V
Rated current UL (Use Group C)	30 A

### Ratings per CSA

Approvals per	C22.2 No 158
Rated voltage CSA (Use Group B)	600 V
Rated current CSA (Use Group B)	30 A
Rated voltage CSA (Use Group C)	600 V
Rated current CSA (Use Group C)	30 A

### Ex information

Ratings per	ATEX: PTB 05 ATEX 1095 U / IECEx: PTB 05.0033U (Ex eb IIC Gb)
Rated voltage EN (Ex e II)	550 V
Rated current (Ex e II)	30 A

### Connection data

Connection technology	Push-in CAGE CLAMP®
Actuation type	Push-in Operating tool
Connectable conductor materials	Copper
Nominal cross-section	4 mm <sup>2</sup>
Solid conductor	0,5 ... 6 mm <sup>2</sup> / 20 ... 10 AWG
Solid conductor; push-in termination	1,5 ... 6 mm <sup>2</sup> / 14 ... 10 AWG
Fine-stranded conductor	0,5 ... 6 mm <sup>2</sup> / 20 ... 10 AWG
Fine-stranded conductor; with insulated ferrule	1,5 ... 4 mm <sup>2</sup> / 18 ... 12 AWG
Fine-stranded conductor; with ferrule; push-in termination	1,5 ... 4 mm <sup>2</sup> / 18 ... 12 AWG
Note (conductor cross-section)	Depending on the conductor characteristic, a conductor with a smaller cross-section can also be inserted via push-in termination.
Strip length	11 ... 13 mm / 0.43 ... 0.51 inch
Total number of connection points	2

Total number of potentials	1
Number of levels	1
Wiring type	Front-entry wiring
Number of jumper slots	2

### Physical data

Width	6,2 mm / 0.244 inch
Height from upper-edge of DIN-rail	32,9 mm / 1.295 inch
Depth	52,3 mm / 2.059 inch

### Mechanical data

Design	horizontal type
Mounting type	DIN-35 rail
Marking level	Center/side marking

### Material data

Color	gray
Insulation material	Polyamide (PA66)
Fire load	0,135 MJ
Weight	7,1 g

### Commercial data

Product Group	22 (TOPJOB S)
Packaging type	BOX
Country of origin	DE
GTIN	4017332071055
Customs tariff number	85369010000

### Съвместими продукти

#### tools



Артикул №: 210-658

Operating tool; Blade: 3.5 x 0.5 mm; with a partially insulated shaft; angled; short; multicoloured



Артикул №: 210-720

Operating tool; Blade: 3.5 x 0.5 mm; with a partially insulated shaft; multicoloured

#### Protective Warning Marker













Артикул №: 2004-115



Protective warning marker; with high-voltage symbol, black; for 5 terminal blocks; yellow

---

**Marking accessories**

	<b>Артикул №: 2009-110</b> Marking strips; for Smart Printer; on reel; not stretchable; plain; snap-on type; white
	<b>Артикул №: 2009-115</b> WMB-Inline; for Smart Printer; 1500 pieces on roll; stretchable 5 - 5.2 mm; plain; snap-on type; white
	<b>Артикул №: 2009-115/000-002</b> WMB-Inline; for Smart Printer; 1500 pieces on roll; stretchable 5 - 5.2 mm; plain; snap-on type; yellow
	<b>Артикул №: 2009-115/000-005</b> WMB-Inline; for Smart Printer; 1500 pieces on roll; stretchable 5 - 5.2 mm; plain; snap-on type; red
	<b>Артикул №: 2009-115/000-006</b> WMB-Inline; for Smart Printer; 1500 pieces on roll; stretchable 5 - 5.2 mm; plain; snap-on type; blue
	<b>Артикул №: 2009-115/000-007</b> WMB-Inline; for Smart Printer; 1500 pieces on roll; stretchable 5 - 5.2 mm; plain; snap-on type; gray
	<b>Артикул №: 2009-115/000-012</b> WMB-Inline; for Smart Printer; 1500 pieces on roll; stretchable 5 - 5.2 mm; plain; snap-on type; orange
	<b>Артикул №: 2009-115/000-017</b> WMB-Inline; for Smart Printer; 1500 pieces on roll; stretchable 5 - 5.2 mm; plain; snap-on type; light green
	<b>Артикул №: 2009-115/000-023</b> WMB-Inline; for Smart Printer; 1500 pieces on roll; stretchable 5 - 5.2 mm; plain; snap-on type; green
	<b>Артикул №: 2009-115/000-024</b> WMB-Inline; for Smart Printer; 1500 pieces on roll; stretchable 5 - 5.2 mm; plain; snap-on type; violet
	<b>Артикул №: 2009-145</b> Mini-WSB Inline; for Smart Printer; 1700 pieces on roll; stretchable 5 - 5.2 mm; plain; snap-on type; white
	<b>Артикул №: 2009-145/000-002</b> Mini-WSB Inline; for Smart Printer; 1700 pieces on roll; stretchable 5 - 5.2 mm; plain; snap-on type; yellow
	<b>Артикул №: 2009-145/000-005</b> Mini-WSB Inline; for Smart Printer; 1700 pieces on roll; stretchable 5 - 5.2 mm; plain; snap-on type; red

 **Артикул №: 2009-145/000-006**  
Mini-WSB Inline; for Smart Printer; 1700 pieces on roll; stretchable 5 - 5.2 mm; plain; snap-on type; blue

 **Артикул №: 2009-145/000-007**  
Mini-WSB Inline; for Smart Printer; 1700 pieces on roll; stretchable 5 - 5.2 mm; plain; snap-on type; gray

 **Артикул №: 2009-145/000-012**  
Mini-WSB Inline; for Smart Printer; 1700 pieces on roll; stretchable 5 - 5.2 mm; plain; snap-on type; orange

 **Артикул №: 2009-145/000-023**  
Mini-WSB Inline; for Smart Printer; 1700 pieces on roll; stretchable 5 - 5.2 mm; plain; snap-on type; green

 **Артикул №: 2009-145/000-024**  
Mini-WSB Inline; for Smart Printer; 1700 pieces on roll; stretchable 5 - 5.2 mm; plain; snap-on type; violet

 **Артикул №: 2009-191**  
Group marker carrier

 **Артикул №: 2009-192**  
Group marker carrier

 **Артикул №: 2009-193**  
Group marker carrier

 **Артикул №: 2009-198**  
Adaptor; gray

 **Артикул №: 248-501**  
Miniature WSB Quick marking system; plain; Marker width 5 mm; 10 strips with 10 markers per card

 **Артикул №: 248-501/000-002**  
Mini-WSB marking card; as card; not stretchable; plain; snap-on type; yellow

 **Артикул №: 248-501/000-005**  
Mini-WSB marking card; as card; not stretchable; plain; snap-on type; red

 **Артикул №: 248-501/000-006**  
Mini-WSB marking card; as card; not stretchable; plain; snap-on type; blue

 **Артикул №: 248-501/000-007**  
Mini-WSB marking card; as card; not stretchable; plain; snap-on type; gray

 **Артикул №: 248-501/000-012**  
Mini-WSB marking card; as card; not stretchable; plain; snap-on type; orange



**Артикул №: 248-501/000-017**

Mini-WSB marking card; as card; not stretchable; plain; snap-on type; light green



**Артикул №: 248-501/000-023**

Mini-WSB marking card; as card; not stretchable; plain; snap-on type; green



**Артикул №: 248-501/000-024**

Mini-WSB marking card; as card; not stretchable; plain; snap-on type; violet



**Артикул №: 793-501**

WMB marking card; as card; not stretchable; plain; snap-on type; white



**Артикул №: 793-501/000-002**

WMB marking card; as card; not stretchable; plain; snap-on type; yellow



**Артикул №: 793-501/000-005**

WMB marking card; as card; not stretchable; plain; snap-on type; red



**Артикул №: 793-501/000-006**

WMB marking card; as card; not stretchable; plain; snap-on type; blue



**Артикул №: 793-501/000-007**

WMB marking card; as card; not stretchable; plain; snap-on type; gray



**Артикул №: 793-501/000-012**

WMB marking card; as card; not stretchable; plain; snap-on type; orange



**Артикул №: 793-501/000-017**

WMB marking card; as card; not stretchable; plain; snap-on type; light green



**Артикул №: 793-501/000-023**

WMB marking card; as card; not stretchable; plain; snap-on type; green



**Артикул №: 793-501/000-024**

WMB marking card; as card; not stretchable; plain; snap-on type; violet



**Артикул №: 793-5501**

WMB marking card; as card; for terminal block width 5 - 17.5 mm; stretchable 5 - 5.2 mm; plain; snap-on type; white



**Артикул №: 793-5501/000-002**

WMB marking card; as card; for terminal block width 5 - 17.5 mm; stretchable 5 - 5.2 mm; plain; snap-on type; yellow

**Артикул №: 793-5501/000-005**

WMB marking card; as card; for terminal block width 5 - 17.5 mm; stretchable 5 - 5.2 mm; plain; snap-on type; red

**Артикул №: 793-5501/000-006**

WMB marking card; as card; for terminal block width 5 - 17.5 mm; stretchable 5 - 5.2 mm; plain; snap-on type; blue

**Артикул №: 793-5501/000-007**

WMB marking card; as card; for terminal block width 5 - 17.5 mm; stretchable 5 - 5.2 mm; plain; snap-on type; gray

**Артикул №: 793-5501/000-012**

WMB marking card; as card; for terminal block width 5 - 17.5 mm; stretchable 5 - 5.2 mm; plain; snap-on type; orange

**Артикул №: 793-5501/000-014**

WMB marking card; as card; for terminal block width 5 - 17.5 mm; stretchable 5 - 5.2 mm; plain; snap-on type; brown

**Артикул №: 793-5501/000-017**

WMB marking card; as card; for terminal block width 5 - 17.5 mm; stretchable 5 - 5.2 mm; plain; snap-on type; green

**Артикул №: 793-5501/000-023**

WMB marking card; as card; for terminal block width 5 - 17.5 mm; stretchable 5 - 5.2 mm; plain; snap-on type; light green

**Артикул №: 793-5501/000-024**

WMB marking card; as card; for terminal block width 5 - 17.5 mm; stretchable 5 - 5.2 mm; plain; snap-on type; violet

**ferrule****Артикул №: 216-262**

Ferrule; Sleeve for 0.75 mm<sup>2</sup> / 18 AWG; insulated; electro-tin plated; electrolytic copper; gastight crimped; acc. to DIN 46228, Part 4/09.90; gray

**Артикул №: 216-263**

Ferrule; Sleeve for 1 mm<sup>2</sup> / AWG 18; insulated; electro-tin plated; electrolytic copper; gastight crimped; acc. to DIN 46228, Part 4/09.90; red

**Артикул №: 216-264**

Ferrule; Sleeve for 1.5 mm<sup>2</sup> / AWG 16; insulated; electro-tin plated; electrolytic copper; gastight crimped; acc. to DIN 46228, Part 4/09.90; black

**Артикул №: 216-266**

Ferrule; Sleeve for 2.5 mm<sup>2</sup> / AWG 14; insulated; electro-tin plated; electrolytic copper; gastight crimped; acc. to DIN 46228, Part 4/09.90; blue

**Артикул №: 216-267**

Ferrule; Sleeve for 4 mm<sup>2</sup> / AWG 12; insulated; electro-tin plated; electrolytic copper; gastight crimped; acc. to DIN 46228, Part 4/09.90; gray

**Insulation stop****Артикул №: 2004-171**



Insulation stop; 0.25 - 0.5 mm<sup>2</sup>; 5 pieces/strip; light gray



**Артикул №: 2004-172**

Insulation stop; 0.75 - 1 mm<sup>2</sup>; 5 pieces/strip; dark gray

**Jumper**



**Артикул №: 2004-402**

Jumper; 2-way; insulated; light gray



**Артикул №: 2004-403**

Jumper; 3-way; insulated; light gray



**Артикул №: 2004-404**

Jumper; 4-way; insulated; light gray



**Артикул №: 2004-405**

Jumper; 5-way; insulated; light gray



**Артикул №: 2004-405/011-000**

Star point jumper; 3-way; insulated; light gray



**Артикул №: 2004-406**

Jumper; 6-way; insulated; light gray



**Артикул №: 2004-406/020-000**

Delta jumper; insulated; light gray



**Артикул №: 2004-407**

Jumper; 7-way; insulated; light gray



**Артикул №: 2004-408**

Jumper; 8-way; insulated; light gray



**Артикул №: 2004-409**

Jumper; 9-way; insulated; light gray



**Артикул №: 2004-410**

Jumper; 10-way; insulated; light gray



**Артикул №: 2004-433**

Jumper; from 1 to 3; insulated; light gray



**Артикул №: 2004-434**

Jumper; from 1 to 4; insulated; light gray



**Артикул №: 2004-435**

Jumper; from 1 to 5; insulated; light gray



**Артикул №: 2004-436**

Jumper; from 1 to 6; insulated; light gray





**Артикул №: 2004-437**  
Jumper; from 1 to 7; insulated; light gray



**Артикул №: 2004-438**  
Jumper; from 1 to 8; insulated; light gray



**Артикул №: 2004-439**  
Jumper; from 1 to 9; insulated; light gray



**Артикул №: 2004-440**  
Jumper; from 1 to 10; insulated; light gray



**Артикул №: 2006-499**  
Step-down jumper; insulated; light gray



**Артикул №: 2016-499**  
Step-down jumper; insulated; light gray



**Артикул №: 210-103**  
Wire commoning chain; insulated; black

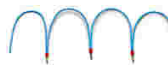

**Артикул №: 210-123**  
Wire commoning chain; insulated; blue

#### End plate



**Артикул №: 2004-1293**  
Separator plate; 2 mm thick; oversized; gray



**Артикул №: 2004-1294**  
Separator plate; 2 mm thick; oversized; orange



**Артикул №: 209-190**  
Separator for Ex e/Ex i applications; 3 mm thick; 90 mm wide; orange



**Артикул №: 209-191**  
Separator for Ex e/Ex i applications; 3 mm thick; 120 mm wide; orange

#### Carrier rail



**Артикул №: 210-112**  
Steel carrier rail; 35 x 7.5 mm; 1 mm thick; 2 m long; slotted; according to EN 60715; "Hole width 25 mm; silver-colored



**Артикул №: 210-113**  
Steel carrier rail; 35 x 7.5 mm; 1 mm thick; 2 m long; unslotted; according to EN 60715; silver-colored



**Артикул №: 210-114**  
Steel carrier rail; 35 x 15 mm; 1.5 mm thick; 2 m long; unslotted; similar to EN 60715; silver-colored



**Артикул №: 210-115**  
Steel carrier rail; 35 x 7.5 mm; 1 mm thick; 2 m long; slotted; according to EN 60715; "Hole width 18 mm; silver-colored



**Артикул №: 210-118**  
Steel carrier rail; 35 x 15 mm; 2.3 mm thick; 2 m long; unslotted; according to EN 60715; silver-colored



**Артикул №: 210-196**

Aluminum carrier rail; 35 x 8.2 mm; 1.6 mm thick; 2 m long; unslotted; similar to EN 60715; silver-colored



**Артикул №: 210-197**

Steel carrier rail; 35 x 15 mm; 1.5 mm thick; 2 m long; slotted; similar to EN 60715; silver-colored



**Артикул №: 210-198**

Copper carrier rail; 35 x 15 mm; 2.3 mm thick; 2 m long; unslotted; according to EN 60715; copper-colored



**Артикул №: 210-504**

Steel carrier rail; 35 x 7.5 mm; 1 mm thick; 2 m long; slotted; galvanized; according to EN 60715



**Артикул №: 210-505**

Steel carrier rail; 35 x 7.5 mm; 1 mm thick; 2 m long; unslotted; galvanized; according to EN 60715; silver-colored



**Артикул №: 210-506**

Steel carrier rail; 35 x 15 mm; 1.5 mm thick; 2 m long; unslotted; galvanized; similar to EN 60715; silver-colored



**Артикул №: 210-508**

Steel carrier rail; 35 x 15 mm; 1.5 mm thick; 2 m long; slotted; galvanized; similar to EN 60715; silver-colored

**check**



**Артикул №: 2004-511**

Modular TOPJOB®S connector; modular; for jumper contact slot; 1-pole; 4,00 mm<sup>2</sup>; gray



**Артикул №: 2004-549**

Spacer module; modular; e.g., for bridging commoned terminal blocks; gray



**Артикул №: 2004-552**

Modular TOPJOB®S connector; modular; for jumper contact slot; 2-pole; 4,00 mm<sup>2</sup>; gray



**Артикул №: 2004-553**

Modular TOPJOB®S connector; modular; for jumper contact slot; 3-pole; 4,00 mm<sup>2</sup>; gray



**Артикул №: 2004-554**

Modular TOPJOB®S connector; modular; for jumper contact slot; 4-pole; 4,00 mm<sup>2</sup>; gray



**Артикул №: 2004-555**

Modular TOPJOB®S connector; modular; for jumper contact slot; 5-pole; 4,00 mm<sup>2</sup>; gray



**Артикул №: 2009-174**

Test plug adapter; for 4 mm Ø test plugs; for testing TOPJOB®S rail-mounted terminal blocks; gray



**Артикул №: 2009-182**

Testing tap; for max. 2.5 mm<sup>2</sup>; tool-free connection for individual test wires 0.08 - 2.5 mm; gray