

## Информационен лист | Номер на артикул: 2002-1204

2-conductor through terminal block; 2.5 mm<sup>2</sup>; for Ex e II and Ex i applications;  
side and center marking; for DIN-rail 35 x 15 and 35 x 7.5; Push-in CAGE  
CLAMP®; 2,50 mm<sup>2</sup>; blue

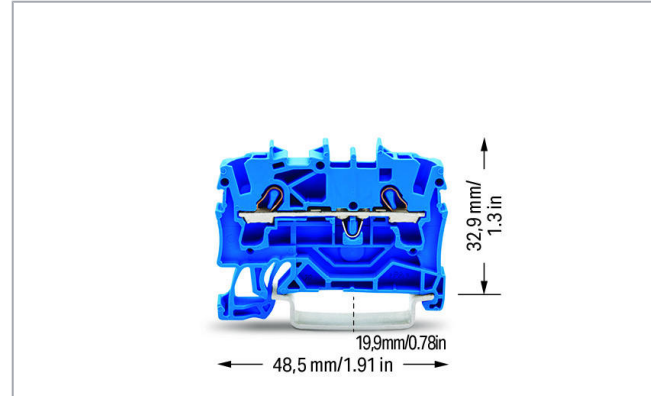
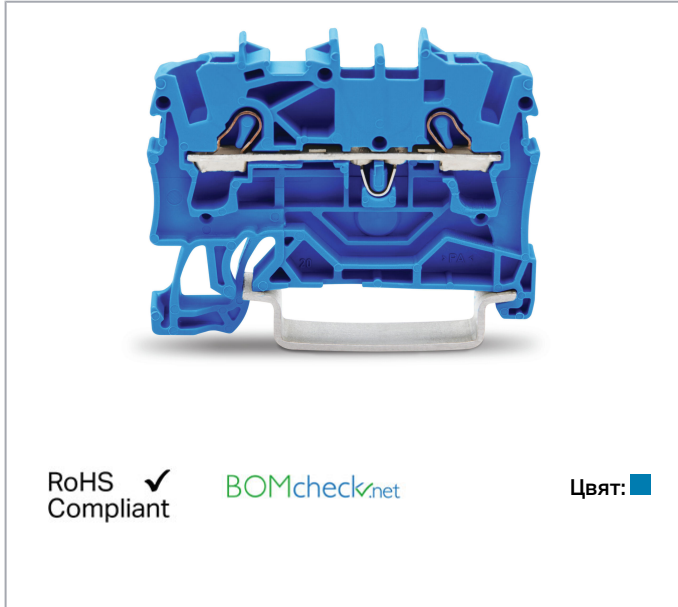

### Данни

#### Electrical data

#### Ratings per IEC/EN 60664-1

Ratings per	IEC/EN 60947-7-1
Nominal voltage (III/3)	800 V
Rated surge voltage (III/3)	8 kV
Rated current	24 A
Rated current 2	32 A
Legend (ratings)	(III / 3) ≙ Overvoltage category III / Pollution degree 3

#### Ratings per UL 1059

Approvals per	UL 1059
Rated voltage UL (Use Group B)	600 V
Rated current UL (Use Group B)	20 A
Rated voltage UL (Use Group C)	600 V
Rated current UL (Use Group C)	20 A

### Ratings per CSA

Approvals per	C22.2 No 158
Rated voltage CSA (Use Group B)	600 V
Rated current CSA (Use Group B)	20 A
Rated voltage CSA (Use Group C)	600 V
Rated current CSA (Use Group C)	20 A

### Ex information

Ratings per	ATEX: PTB 03 ATEX 1162 U / IECEx: PTB 03.0004U (Ex eb IIC Gb)
Rated voltage EN (Ex e II)	550 V
Rated current (Ex e II)	22 A
Rated current (Ex e II) with jumper	20 A

### Connection data

Connection technology	Push-in CAGE CLAMP®
Actuation type	Push-in Operating tool
Connectable conductor materials	Copper
Nominal cross-section	2,5 mm <sup>2</sup>
Solid conductor	0,25 ... 4 mm <sup>2</sup> / 22 ... 12 AWG
Solid conductor; push-in termination	0,75 ... 4 mm <sup>2</sup> / 18 ... 12 AWG
Fine-stranded conductor	0,25 ... 4 mm <sup>2</sup> / 22 ... 12 AWG
Fine-stranded conductor; with insulated ferrule	1 ... 2,5 mm <sup>2</sup> / 18 ... 14 AWG
Fine-stranded conductor; with ferrule; push-in termination	1 ... 2,5 mm <sup>2</sup> / 18 ... 14 AWG
Note (conductor cross-section)	Depending on the conductor characteristic, a conductor with a smaller cross-section can also be inserted via push-in termination.
Strip length	10 ... 12 mm / 0.39 ... 0.47 inch
Total number of connection points	2
Total number of potentials	1
Number of levels	1
Wiring type	Front-entry wiring
Number of jumper slots	2

### Physical data

Width	5,2 mm / 0.205 inch
Height from upper-edge of DIN-rail	32,9 mm / 1.295 inch

Depth	48,5 mm / 1.909 inch
-------	----------------------

### Mechanical data

Design	horizontal type
Mounting type	DIN-35 rail
Marking level	Center/side marking

### Material data







Color	blue
Insulation material	Polyamide (PA66)
Fire load	0,109 MJ
Weight	4,9 g

### Commercial data

Product Group	22 (TOPJOB S)
Packaging type	BOX
Country of origin	DE
GTIN	4017332999175
Customs tariff number	85369010000

### Съвместими продукти

#### Jumper

	<b>Артикул №: 2002-400</b> Continuous jumper; 2-way; insulated; light gray
	<b>Артикул №: 2002-402</b> Jumper; 2-way; insulated; light gray
	<b>Артикул №: 2002-402/000-005</b> Jumper; 2-way; insulated; red
	<b>Артикул №: 2002-402/000-006</b> Jumper; 2-way; insulated; blue
	<b>Артикул №: 2002-403</b> Jumper; 3-way; insulated; light gray
	<b>Артикул №: 2002-403/000-005</b> Jumper; 3-way; insulated; red



Артикул №: 2002-403/000-006  
Jumper; 3-way; insulated; blue

---



Артикул №: 2002-404  
Jumper; 4-way; insulated; light gray

---



Артикул №: 2002-404/000-005  
Jumper; 4-way; insulated; red

---



Артикул №: 2002-404/000-006  
Jumper; 4-way; insulated; blue

---



Артикул №: 2002-405  
Jumper; 5-way; insulated; light gray

---



Артикул №: 2002-405/000-005  
Jumper; 5-way; insulated; red

---



Артикул №: 2002-405/000-006  
Jumper; 5-way; insulated; blue

---



Артикул №: 2002-405/011-000  
Star point jumper; 3-way; insulated; light gray

---



Артикул №: 2002-406  
Jumper; 6-way; insulated; light gray

---



Артикул №: 2002-406/000-005  
Jumper; 6-way; insulated; red

---



Артикул №: 2002-406/000-006  
Jumper; 6-way; insulated; blue

---



Артикул №: 2002-406/020-000  
Delta jumper; insulated; light gray

---



Артикул №: 2002-407  
Jumper; 7-way; insulated; light gray

---



Артикул №: 2002-407/000-005  
Jumper; 7-way; insulated; red

---



Артикул №: 2002-407/000-006  
Jumper; 7-way; insulated; blue



Артикул №: 2002-408  
Jumper; 8-way; insulated; light gray



Артикул №: 2002-408/000-005  
Jumper; 8-way; insulated; red



Артикул №: 2002-408/000-006  
Jumper; 8-way; insulated; blue



Артикул №: 2002-409  
Jumper; 9-way; insulated; light gray



Артикул №: 2002-409/000-005  
Jumper; 9-way; insulated; red



Артикул №: 2002-409/000-006  
Jumper; 9-way; insulated; blue



Артикул №: 2002-410  
Jumper; 10-way; insulated; light gray



Артикул №: 2002-410/000-005  
Jumper; 10-way; insulated; red



Артикул №: 2002-410/000-006  
Jumper; 10-way; insulated; blue



Артикул №: 2002-423  
Continuous jumper; from 1 to 3; insulated; light gray



Артикул №: 2002-423/000-005  
Continuous jumper; from 1 to 3; insulated; red



Артикул №: 2002-423/000-006  
Continuous jumper; from 1 to 3; insulated; blue



Артикул №: 2002-433  
Jumper; from 1 to 3; insulated; light gray



Артикул №: 2002-434  
Jumper; from 1 to 4; insulated; light gray



Артикул №: 2002-435  
Jumper; from 1 to 5; insulated; light gray



Артикул №: 2002-436  
Jumper; from 1 to 6; insulated; light gray



Артикул №: 2002-437  
Jumper; from 1 to 7; insulated; light gray



Артикул №: 2002-438  
Jumper; from 1 to 8; insulated; light gray



Артикул №: 2002-439  
Jumper; from 1 to 9; insulated; light gray



Артикул №: 2002-440  
Jumper; from 1 to 10; insulated; light gray



Артикул №: 2002-472  
Staggered jumper; 2-way; insulated; light gray



Артикул №: 2002-473  
Staggered jumper; 3-way; insulated; light gray

Артикул №: 2002-473/011-000  
Staggered jumper; 2-way; from 1 to 3; insulated; light gray



Артикул №: 2002-474  
Staggered jumper; 4-way; insulated; light gray



Артикул №: 2002-475  
Staggered jumper; 5-way; insulated; light gray

Артикул №: 2002-475/011-000  
Staggered jumper; 3-way; insulated; light gray



Артикул №: 2002-476  
Staggered jumper; 6-way; insulated; light gray



Артикул №: 2002-477  
Staggered jumper; 7-way; insulated; light gray



Артикул №: 2002-477/011-000  
Staggered jumper; insulated; light gray



Артикул №: 2002-478  
Staggered jumper; 8-way; insulated; light gray



Артикул №: 2002-479  
Staggered jumper; 9-way; insulated; light gray

Артикул №: 2002-479/011-000  
Staggered jumper; insulated; light gray



Артикул №: 2002-480  
Staggered jumper; 10-way; insulated; light gray



Артикул №: 2002-481  
Staggered jumper; 11-way; insulated; light gray

Артикул №: 2002-481/011-000  
Staggered jumper; insulated; light gray



Артикул №: 2002-482  
Staggered jumper; 12-way; insulated; light gray



Артикул №: 2006-499  
Step-down jumper; insulated; light gray



Артикул №: 2016-499  
Step-down jumper; insulated; light gray



Артикул №: 210-103  
Wire commoning chain; insulated; black

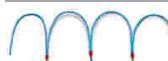

Артикул №: 210-123  
Wire commoning chain; insulated; blue

#### Push-In type wire jumper



Артикул №: 2009-412  
Push-in type wire jumper; insulated; 60 mm long; black



Артикул №: 2009-414  
Push-in type wire jumper; 1.5 mm<sup>2</sup>; insulated; 110 mm long; black



Артикул №: 2009-414/000-005  
Push-in type wire jumper; 1.5 mm<sup>2</sup>; insulated; 110 mm long; black



Артикул №: 2009-414/000-006  
Push-in type wire jumper; insulated; 110 mm long; black



Артикул №: 2009-416  
Push-in type wire jumper; 1.5 mm<sup>2</sup>; insulated; 250 mm long; black

#### Protective Warning Marker



Артикул №: 2002-115  
Protective warning marker; with high-voltage symbol, black; for 5 terminal blocks; yellow

#### tools



Артикул №: 210-658  
Operating tool; Blade: 3.5 x 0.5 mm; with a partially insulated shaft; angled; short; multicoloured



**Артикул №: 210-720**

Operating tool; Blade: 3.5 x 0.5 mm; with a partially insulated shaft; multicoloured

#### Insulation stop



**Артикул №: 2002-171**

Insulation stop; 0.25 - 0.5 mm<sup>2</sup>; 5 pieces/strip; light gray



**Артикул №: 2002-172**

Insulation stop; 0.75 - 1 mm<sup>2</sup>; 5 pieces/strip; dark gray

#### check



**Артикул №: 2002-511**

Modular TOPJOB®S connector; modular; for jumper contact slot; 1-pole; 2,50 mm<sup>2</sup>; gray



**Артикул №: 2002-549**

Spacer module; modular; e.g., for bridging commoned terminal blocks; gray



**Артикул №: 2002-552**

Modular TOPJOB®S connector; modular; for jumper contact slot; 2-pole; 2,50 mm<sup>2</sup>; gray



**Артикул №: 2002-553**

Modular TOPJOB®S connector; modular; for jumper contact slot; 3-pole; 2,50 mm<sup>2</sup>; gray



**Артикул №: 2002-554**

Modular TOPJOB®S connector; modular; for jumper contact slot; 4-pole; 2,50 mm<sup>2</sup>; gray



**Артикул №: 2002-555**

Modular TOPJOB®S connector; modular; for jumper contact slot; 5-pole; 2,50 mm<sup>2</sup>; gray



**Артикул №: 2002-556**

Modular TOPJOB®S connector; modular; for jumper contact slot; 6-pole; 2,50 mm<sup>2</sup>; gray



**Артикул №: 2002-557**

Modular TOPJOB®S connector; modular; for jumper contact slot; 7-pole; 2,50 mm<sup>2</sup>; gray



**Артикул №: 2002-558**

Modular TOPJOB®S connector; modular; for jumper contact slot; 8-pole; 2,50 mm<sup>2</sup>; gray



**Артикул №: 2002-559**

Modular TOPJOB®S connector; modular; for jumper contact slot; 9-pole; 2,50 mm<sup>2</sup>; gray



**Артикул №: 2002-560**

Modular TOPJOB®S connector; modular; for jumper contact slot; 10-pole; 2,50 mm<sup>2</sup>; gray



**Артикул №: 2002-611**

TOPJOB®S L-type test plug module; modular; 1-pole; 2,50 mm<sup>2</sup>; gray



**Артикул №: 2002-649**

TOPJOB®S L-type spacer module; modular; e.g., for bridging commoned terminal blocks; gray



**Артикул №: 2009-174**

Test plug adapter; for 4 mm Ø test plugs; for testing TOPJOB®S rail-mounted terminal blocks; gray



**Артикул №: 2009-182**Testing tap; for max. 2.5 mm<sup>2</sup>; tool-free connection for individual test wires 0.08 - 2.5 mm; gray**End plate****Артикул №: 2002-1293**

Separator plate; 2 mm thick; oversized; gray

**Артикул №: 2002-1294**

Separator plate; 2 mm thick; oversized; orange

**Артикул №: 209-190**

Separator for Ex e/Ex i applications; 3 mm thick; 90 mm wide; orange

**Артикул №: 209-191**

Separator for Ex e/Ex i applications; 3 mm thick; 120 mm wide; orange

**Marking accessories****Артикул №: 2002-161**

Adaptor; gray

**Артикул №: 2009-110**

Marking strips; for Smart Printer; on reel; not stretchable; plain; snap-on type; white

**Артикул №: 2009-115**

WMB-Inline; for Smart Printer; 1500 pieces on roll; stretchable 5 - 5.2 mm; plain; snap-on type; white

**Артикул №: 2009-115/000-002**

WMB-Inline; for Smart Printer; 1500 pieces on roll; stretchable 5 - 5.2 mm; plain; snap-on type; yellow

**Артикул №: 2009-115/000-005**

WMB-Inline; for Smart Printer; 1500 pieces on roll; stretchable 5 - 5.2 mm; plain; snap-on type; red

**Артикул №: 2009-115/000-006**

WMB-Inline; for Smart Printer; 1500 pieces on roll; stretchable 5 - 5.2 mm; plain; snap-on type; blue

**Артикул №: 2009-115/000-007**

WMB-Inline; for Smart Printer; 1500 pieces on roll; stretchable 5 - 5.2 mm; plain; snap-on type; gray

**Артикул №: 2009-115/000-012**

WMB-Inline; for Smart Printer; 1500 pieces on roll; stretchable 5 - 5.2 mm; plain; snap-on type; orange

**Артикул №: 2009-115/000-017**

WMB-Inline; for Smart Printer; 1500 pieces on roll; stretchable 5 - 5.2 mm; plain; snap-on type; light green

**Артикул №: 2009-115/000-023**

WMB-Inline; for Smart Printer; 1500 pieces on roll; stretchable 5 - 5.2 mm; plain; snap-on type; green



**Артикул №: 2009-115/000-024**

WMB-Inline; for Smart Printer; 1500 pieces on roll; stretchable 5 - 5.2 mm; plain; snap-on type; violet



**Артикул №: 2009-145**

Mini-WSB Inline; for Smart Printer; 1700 pieces on roll; stretchable 5 - 5.2 mm; plain; snap-on type; white



**Артикул №: 2009-145/000-002**

Mini-WSB Inline; for Smart Printer; 1700 pieces on roll; stretchable 5 - 5.2 mm; plain; snap-on type; yellow



**Артикул №: 2009-145/000-005**

Mini-WSB Inline; for Smart Printer; 1700 pieces on roll; stretchable 5 - 5.2 mm; plain; snap-on type; red



**Артикул №: 2009-145/000-006**

Mini-WSB Inline; for Smart Printer; 1700 pieces on roll; stretchable 5 - 5.2 mm; plain; snap-on type; blue



**Артикул №: 2009-145/000-007**

Mini-WSB Inline; for Smart Printer; 1700 pieces on roll; stretchable 5 - 5.2 mm; plain; snap-on type; gray



**Артикул №: 2009-145/000-012**

Mini-WSB Inline; for Smart Printer; 1700 pieces on roll; stretchable 5 - 5.2 mm; plain; snap-on type; orange



**Артикул №: 2009-145/000-023**

Mini-WSB Inline; for Smart Printer; 1700 pieces on roll; stretchable 5 - 5.2 mm; plain; snap-on type; green



**Артикул №: 2009-145/000-024**

Mini-WSB Inline; for Smart Printer; 1700 pieces on roll; stretchable 5 - 5.2 mm; plain; snap-on type; violet



**Артикул №: 2009-191**

Group marker carrier



**Артикул №: 2009-192**

Group marker carrier



**Артикул №: 2009-193**

Group marker carrier



**Артикул №: 2009-198**

Adaptor; gray



**Артикул №: 248-501**

Miniature WSB Quick marking system; plain; Marker width 5 mm; 10 strips with 10 markers per card



**Артикул №: 248-501/000-002**

Mini-WSB marking card; as card; not stretchable; plain; snap-on type; yellow



**Артикул №: 248-501/000-005**  
Mini-WSB marking card; as card; not stretchable; plain; snap-on type; red

---



**Артикул №: 248-501/000-006**  
Mini-WSB marking card; as card; not stretchable; plain; snap-on type; blue

---



**Артикул №: 248-501/000-007**  
Mini-WSB marking card; as card; not stretchable; plain; snap-on type; gray

---



**Артикул №: 248-501/000-012**  
Mini-WSB marking card; as card; not stretchable; plain; snap-on type; orange

---



**Артикул №: 248-501/000-017**  
Mini-WSB marking card; as card; not stretchable; plain; snap-on type; light green

---



**Артикул №: 248-501/000-023**  
Mini-WSB marking card; as card; not stretchable; plain; snap-on type; green

---



**Артикул №: 248-501/000-024**  
Mini-WSB marking card; as card; not stretchable; plain; snap-on type; violet

---



**Артикул №: 793-501**  
WMB marking card; as card; not stretchable; plain; snap-on type; white

---



**Артикул №: 793-501/000-002**  
WMB marking card; as card; not stretchable; plain; snap-on type; yellow

---



**Артикул №: 793-501/000-005**  
WMB marking card; as card; not stretchable; plain; snap-on type; red

---



**Артикул №: 793-501/000-006**  
WMB marking card; as card; not stretchable; plain; snap-on type; blue

---



**Артикул №: 793-501/000-007**  
WMB marking card; as card; not stretchable; plain; snap-on type; gray

---



**Артикул №: 793-501/000-012**  
WMB marking card; as card; not stretchable; plain; snap-on type; orange

---



**Артикул №: 793-501/000-017**  
WMB marking card; as card; not stretchable; plain; snap-on type; light green



**Артикул №: 793-501/000-023**  
WMB marking card; as card; not stretchable; plain; snap-on type; green



**Артикул №: 793-501/000-024**  
WMB marking card; as card; not stretchable; plain; snap-on type; violet



**Артикул №: 793-5501**  
WMB marking card; as card; for terminal block width 5 - 17.5 mm; stretchable 5 - 5.2 mm; plain; snap-on type; white



**Артикул №: 793-5501/000-002**  
WMB marking card; as card; for terminal block width 5 - 17.5 mm; stretchable 5 - 5.2 mm; plain; snap-on type; yellow



**Артикул №: 793-5501/000-005**  
WMB marking card; as card; for terminal block width 5 - 17.5 mm; stretchable 5 - 5.2 mm; plain; snap-on type; red



**Артикул №: 793-5501/000-006**  
WMB marking card; as card; for terminal block width 5 - 17.5 mm; stretchable 5 - 5.2 mm; plain; snap-on type; blue



**Артикул №: 793-5501/000-007**  
WMB marking card; as card; for terminal block width 5 - 17.5 mm; stretchable 5 - 5.2 mm; plain; snap-on type; gray



**Артикул №: 793-5501/000-012**  
WMB marking card; as card; for terminal block width 5 - 17.5 mm; stretchable 5 - 5.2 mm; plain; snap-on type; orange



**Артикул №: 793-5501/000-014**  
WMB marking card; as card; for terminal block width 5 - 17.5 mm; stretchable 5 - 5.2 mm; plain; snap-on type; brown



**Артикул №: 793-5501/000-017**  
WMB marking card; as card; for terminal block width 5 - 17.5 mm; stretchable 5 - 5.2 mm; plain; snap-on type; green



**Артикул №: 793-5501/000-023**  
WMB marking card; as card; for terminal block width 5 - 17.5 mm; stretchable 5 - 5.2 mm; plain; snap-on type; light green



**Артикул №: 793-5501/000-024**  
WMB marking card; as card; for terminal block width 5 - 17.5 mm; stretchable 5 - 5.2 mm; plain; snap-on type; violet

**plug**



**Артикул №: 2002-880**  
Empty component plug housing; 10.4 mm wide; 2-pole; Type 4; gray

**Артикул №: 2002-880/1000-411**

Component plug; 2-pole; with diode 1N4007; 10.4 mm wide; Operating temperature 85°C max.; gray

**Артикул №: 2002-880/1000-541**

Component plug; 2-pole; LED (red); 10.4 mm wide; Operating temperature 85°C max.; gray

**Артикул №: 2002-880/1000-542**

Component plug; 2-pole; LED (red); 10.4 mm wide; Operating temperature 85°C max.; multicoloured

**Артикул №: 2002-880/1000-836**

Component plug; 2-pole; LED (red); 10.4 mm wide; Operating temperature 85°C max.; gray

**Carrier rail****Артикул №: 210-112**

Steel carrier rail; 35 x 7.5 mm; 1 mm thick; 2 m long; slotted; according to EN 60715; "Hole width 25 mm; silver-colored

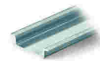
**Артикул №: 210-113**

Steel carrier rail; 35 x 7.5 mm; 1 mm thick; 2 m long; unslotted; according to EN 60715; silver-colored

**Артикул №: 210-114**

Steel carrier rail; 35 x 15 mm; 1.5 mm thick; 2 m long; unslotted; similar to EN 60715; silver-colored

**Артикул №: 210-115**

Steel carrier rail; 35 x 7.5 mm; 1 mm thick; 2 m long; slotted; according to EN 60715; "Hole width 18 mm; silver-colored

**Артикул №: 210-118**

Steel carrier rail; 35 x 15 mm; 2.3 mm thick; 2 m long; unslotted; according to EN 60715; silver-colored

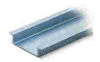
**Артикул №: 210-196**

Aluminum carrier rail; 35 x 8.2 mm; 1.6 mm thick; 2 m long; unslotted; similar to EN 60715; silver-colored

**Артикул №: 210-197**

Steel carrier rail; 35 x 15 mm; 1.5 mm thick; 2 m long; slotted; similar to EN 60715; silver-colored

**Артикул №: 210-198**

Copper carrier rail; 35 x 15 mm; 2.3 mm thick; 2 m long; unslotted; according to EN 60715; copper-colored

**Артикул №: 210-504**

Steel carrier rail; 35 x 7.5 mm; 1 mm thick; 2 m long; slotted; galvanized; according to EN 60715

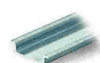
**Артикул №: 210-505**

Steel carrier rail; 35 x 7.5 mm; 1 mm thick; 2 m long; unslotted; galvanized; according to EN 60715; silver-colored

**Артикул №: 210-506**

Steel carrier rail; 35 x 15 mm; 1.5 mm thick; 2 m long; unslotted; galvanized; similar to EN 60715; silver-colored









**Артикул №: 210-508**

Steel carrier rail; 35 x 15 mm; 1.5 mm thick; 2 m long; slotted; galvanized; similar to EN 60715; silver-



colored

## ferrule

	<b>Артикул №: 216-241</b> Ferrule; Sleeve for 0.5 mm <sup>2</sup> / 20 AWG; insulated; electro-tin plated; electrolytic copper; gastight crimped; acc. to DIN 46228, Part 4/09.90; white
	<b>Артикул №: 216-242</b> Ferrule; Sleeve for 0.75 mm <sup>2</sup> / 18 AWG; insulated; electro-tin plated; electrolytic copper; gastight crimped; acc. to DIN 46228, Part 4/09.90; gray
	<b>Артикул №: 216-243</b> Ferrule; Sleeve for 1 mm <sup>2</sup> / AWG 18; insulated; electro-tin plated; electrolytic copper; gastight crimped; acc. to DIN 46228, Part 4/09.90; red
	<b>Артикул №: 216-244</b> Ferrule; Sleeve for 1.5 mm <sup>2</sup> / AWG 16; insulated; electro-tin plated; electrolytic copper; gastight crimped; acc. to DIN 46228, Part 4/09.90; black
	<b>Артикул №: 216-246</b> Ferrule; Sleeve for 2.5 mm <sup>2</sup> / AWG 14; insulated; electro-tin plated; electrolytic copper; gastight crimped; acc. to DIN 46228, Part 4/09.90; blue
	<b>Артикул №: 216-262</b> Ferrule; Sleeve for 0.75 mm <sup>2</sup> / 18 AWG; insulated; electro-tin plated; electrolytic copper; gastight crimped; acc. to DIN 46228, Part 4/09.90; gray
	<b>Артикул №: 216-263</b> Ferrule; Sleeve for 1 mm <sup>2</sup> / AWG 18; insulated; electro-tin plated; electrolytic copper; gastight crimped; acc. to DIN 46228, Part 4/09.90; red
	<b>Артикул №: 216-264</b> Ferrule; Sleeve for 1.5 mm <sup>2</sup> / AWG 16; insulated; electro-tin plated; electrolytic copper; gastight crimped; acc. to DIN 46228, Part 4/09.90; black
	<b>Артикул №: 216-266</b> Ferrule; Sleeve for 2.5 mm <sup>2</sup> / AWG 14; insulated; electro-tin plated; electrolytic copper; gastight crimped; acc. to DIN 46228, Part 4/09.90; blue