

Информационен лист | Номер на артикул: 2004-1204

2-conductor through terminal block; 4 mm²; for Ex e II and Ex i applications;
side and center marking; for DIN-rail 35 x 15 and 35 x 7.5; Push-in CAGE
CLAMP®; 4,00 mm²; blue

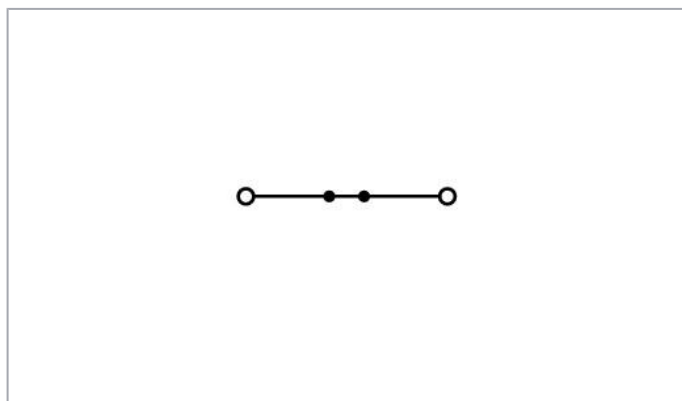
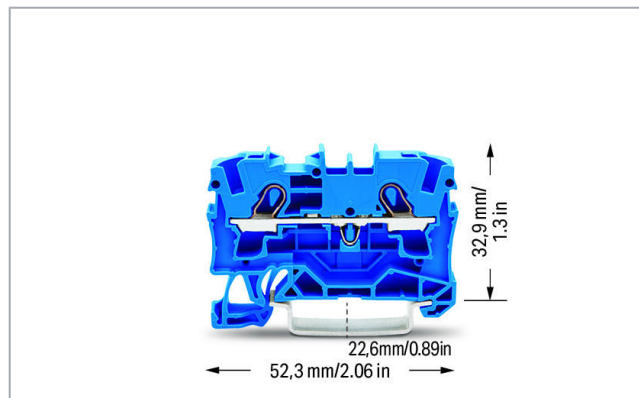
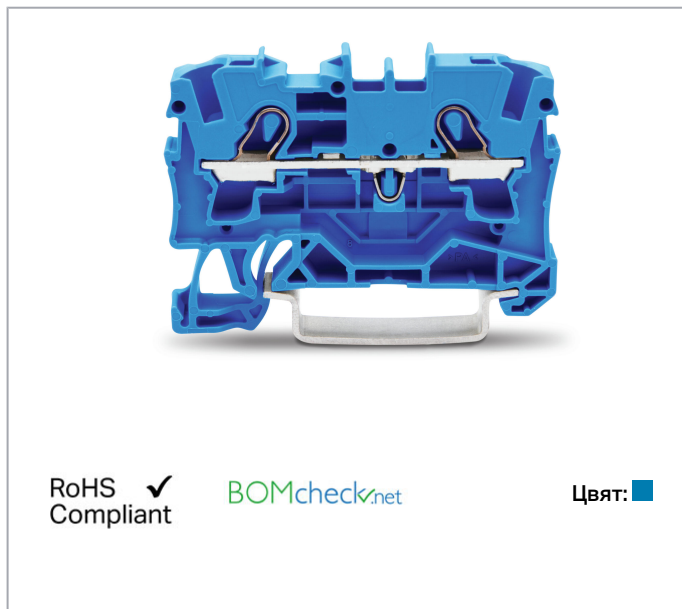

Данни Electrical data

Ratings per IEC/EN 60664-1

Ratings per	IEC/EN 60947-7-1
Nominal voltage (III/3)	800 V
Rated surge voltage (III/3)	8 kV
Rated current	32 A

Rated current 2	41 A
Legend (ratings)	(III / 3) \triangle Overvoltage category III / Pollution degree 3

Ratings per UL 1059

Approvals per	UL 1059
Rated voltage UL (Use Group B)	600 V
Rated current UL (Use Group B)	30 A
Rated voltage UL (Use Group C)	600 V
Rated current UL (Use Group C)	30 A

Ratings per CSA

Approvals per	C22.2 No 158
Rated voltage CSA (Use Group B)	600 V
Rated current CSA (Use Group B)	30 A
Rated voltage CSA (Use Group C)	600 V
Rated current CSA (Use Group C)	30 A

Ex information

Ratings per	ATEX: PTB 05 ATEX 1095 U / IECEx: PTB 05.0033U (Ex eb IIC Gb)
Rated voltage EN (Ex e II)	550 V
Rated current (Ex e II)	30 A

Connection data

Connection technology	Push-in CAGE CLAMP®
Actuation type	Push-in Operating tool
Connectable conductor materials	Copper
Nominal cross-section	4 mm ²
Solid conductor	0,5 ... 6 mm ² / 20 ... 10 AWG
Solid conductor; push-in termination	1,5 ... 6 mm ² / 14 ... 10 AWG
Fine-stranded conductor	0,5 ... 6 mm ² / 20 ... 10 AWG
Fine-stranded conductor; with insulated ferrule	1,5 ... 4 mm ² / 18 ... 12 AWG
Fine-stranded conductor; with ferrule; push-in termination	1,5 ... 4 mm ² / 18 ... 12 AWG
Note (conductor cross-section)	Depending on the conductor characteristic, a conductor with a smaller cross-section can also be inserted via push-in termination.
Strip length	11 ... 13 mm / 0.43 ... 0.51 inch
Total number of connection points	2

Total number of potentials	1
Number of levels	1
Wiring type	Front-entry wiring
Number of jumper slots	2

Physical data

Width	6,2 mm / 0.244 inch
Height from upper-edge of DIN-rail	32,9 mm / 1.295 inch
Depth	52,3 mm / 2.059 inch

Mechanical data

Design	horizontal type
Mounting type	DIN-35 rail
Marking level	Center/side marking

Material data

Color	blue
Insulation material	Polyamide (PA66)
Fire load	0,114 MJ
Weight	6,3 g

Commercial data

Product Group	22 (TOPJOB S)
Packaging type	BOX
Country of origin	DE
GTIN	4017332071086
Customs tariff number	85369010000

Съвместими продукти

check



Артикул №: 2004-511

Modular TOPJOB®S connector; modular; for jumper contact slot; 1-pole; 4,00 mm²; gray



Артикул №: 2004-549

Spacer module; modular; e.g., for bridging commoned terminal blocks; gray



Артикул №: 2004-552

Modular TOPJOB®S connector; modular; for jumper contact slot; 2-pole; 4,00 mm²; gray



Артикул №: 2004-553
Modular TOPJOB®S connector; modular; for jumper contact slot; 3-pole; 4,00 mm²; gray



Артикул №: 2004-554
Modular TOPJOB®S connector; modular; for jumper contact slot; 4-pole; 4,00 mm²; gray



Артикул №: 2004-555
Modular TOPJOB®S connector; modular; for jumper contact slot; 5-pole; 4,00 mm²; gray



Артикул №: 2009-174
Test plug adapter; for 4 mm Ø test plugs; for testing TOPJOB®S rail-mounted terminal blocks; gray



Артикул №: 2009-182
Testing tap; for max. 2.5 mm²; tool-free connection for individual test wires 0.08 - 2.5 mm; gray

Jumper



Артикул №: 2004-402
Jumper; 2-way; insulated; light gray



Артикул №: 2004-403
Jumper; 3-way; insulated; light gray



Артикул №: 2004-404
Jumper; 4-way; insulated; light gray



Артикул №: 2004-405
Jumper; 5-way; insulated; light gray



Артикул №: 2004-405/011-000
Star point jumper; 3-way; insulated; light gray



Артикул №: 2004-406
Jumper; 6-way; insulated; light gray



Артикул №: 2004-406/020-000
Delta jumper; insulated; light gray



Артикул №: 2004-407
Jumper; 7-way; insulated; light gray



Артикул №: 2004-408
Jumper; 8-way; insulated; light gray



Артикул №: 2004-409
Jumper; 9-way; insulated; light gray



Артикул №: 2004-410
Jumper; 10-way; insulated; light gray



Артикул №: 2004-433
Jumper; from 1 to 3; insulated; light gray



Артикул №: 2004-434
Jumper; from 1 to 4; insulated; light gray



Артикул №: 2004-435
Jumper; from 1 to 5; insulated; light gray



Артикул №: 2004-436
Jumper; from 1 to 6; insulated; light gray



Артикул №: 2004-437
Jumper; from 1 to 7; insulated; light gray



Артикул №: 2004-438
Jumper; from 1 to 8; insulated; light gray



Артикул №: 2004-439
Jumper; from 1 to 9; insulated; light gray



Артикул №: 2004-440
Jumper; from 1 to 10; insulated; light gray



Артикул №: 2006-499
Step-down jumper; insulated; light gray



Артикул №: 2016-499
Step-down jumper; insulated; light gray



Артикул №: 210-103
Wire commoning chain; insulated; black

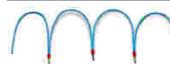

Артикул №: 210-123
Wire commoning chain; insulated; blue

ferrule



Артикул №: 216-262
Ferrule; Sleeve for 0.75 mm² / 18 AWG; insulated; electro-tin plated; electrolytic copper; gastight crimped; acc. to DIN 46228, Part 4/09.90; gray



Артикул №: 216-263
Ferrule; Sleeve for 1 mm² / AWG 18; insulated; electro-tin plated; electrolytic copper; gastight crimped; acc. to DIN 46228, Part 4/09.90; red



Артикул №: 216-264
Ferrule; Sleeve for 1.5 mm² / AWG 16; insulated; electro-tin plated; electrolytic copper; gastight crimped; acc. to DIN 46228, Part 4/09.90; black



Артикул №: 216-266
Ferrule; Sleeve for 2.5 mm² / AWG 14; insulated; electro-tin plated; electrolytic copper; gastight crimped; acc. to DIN 46228, Part 4/09.90; blue



Артикул №: 216-267
Ferrule; Sleeve for 4 mm² / AWG 12; insulated; electro-tin plated; electrolytic copper; gastight crimped; acc. to DIN 46228, Part 4/09.90; gray

Protective Warning Marker

Артикул №: 2004-115
Protective warning marker; with high-voltage symbol, black; for 5 terminal blocks; yellow



tools

**Артикул №: 210-658**

Operating tool; Blade: 3.5 x 0.5 mm; with a partially insulated shaft; angled; short; multicoloured

**Артикул №: 210-720**

Operating tool; Blade: 3.5 x 0.5 mm; with a partially insulated shaft; multicoloured

Carrier rail

**Артикул №: 210-112**

Steel carrier rail; 35 x 7.5 mm; 1 mm thick; 2 m long; slotted; according to EN 60715; "Hole width 25 mm; silver-colored

**Артикул №: 210-113**

Steel carrier rail; 35 x 7.5 mm; 1 mm thick; 2 m long; unslotted; according to EN 60715; silver-colored

**Артикул №: 210-114**

Steel carrier rail; 35 x 15 mm; 1.5 mm thick; 2 m long; unslotted; similar to EN 60715; silver-colored

**Артикул №: 210-115**

Steel carrier rail; 35 x 7.5 mm; 1 mm thick; 2 m long; slotted; according to EN 60715; "Hole width 18 mm; silver-colored

**Артикул №: 210-118**

Steel carrier rail; 35 x 15 mm; 2.3 mm thick; 2 m long; unslotted; according to EN 60715; silver-colored

**Артикул №: 210-196**

Aluminum carrier rail; 35 x 8.2 mm; 1.6 mm thick; 2 m long; unslotted; similar to EN 60715; silver-colored

**Артикул №: 210-197**

Steel carrier rail; 35 x 15 mm; 1.5 mm thick; 2 m long; slotted; similar to EN 60715; silver-colored

**Артикул №: 210-198**

Copper carrier rail; 35 x 15 mm; 2.3 mm thick; 2 m long; unslotted; according to EN 60715; copper-colored

**Артикул №: 210-504**

Steel carrier rail; 35 x 7.5 mm; 1 mm thick; 2 m long; slotted; galvanized; according to EN 60715

**Артикул №: 210-505**

Steel carrier rail; 35 x 7.5 mm; 1 mm thick; 2 m long; unslotted; galvanized; according to EN 60715; silver-colored

**Артикул №: 210-506**

Steel carrier rail; 35 x 15 mm; 1.5 mm thick; 2 m long; unslotted; galvanized; similar to EN 60715; silver-colored

**Артикул №: 210-508**

Steel carrier rail; 35 x 15 mm; 1.5 mm thick; 2 m long; slotted; galvanized; similar to EN 60715; silver-colored

End plate

**Артикул №: 2004-1293**

Separator plate; 2 mm thick; oversized; gray



Артикул №: 2004-1294
Separator plate; 2 mm thick; oversized; orange



Артикул №: 209-190
Separator for Ex e/Ex i applications; 3 mm thick; 90 mm wide; orange



Артикул №: 209-191
Separator for Ex e/Ex i applications; 3 mm thick; 120 mm wide; orange

Insulation stop



Артикул №: 2004-171
Insulation stop; 0.25 - 0.5 mm²; 5 pieces/strip; light gray



Артикул №: 2004-172
Insulation stop; 0.75 - 1 mm²; 5 pieces/strip; dark gray

Marking accessories



Артикул №: 2009-110
Marking strips; for Smart Printer; on reel; not stretchable; plain; snap-on type; white



Артикул №: 2009-115
WMB-Inline; for Smart Printer; 1500 pieces on roll; stretchable 5 - 5.2 mm; plain; snap-on type; white



Артикул №: 2009-115/000-002
WMB-Inline; for Smart Printer; 1500 pieces on roll; stretchable 5 - 5.2 mm; plain; snap-on type; yellow



Артикул №: 2009-115/000-005
WMB-Inline; for Smart Printer; 1500 pieces on roll; stretchable 5 - 5.2 mm; plain; snap-on type; red



Артикул №: 2009-115/000-006
WMB-Inline; for Smart Printer; 1500 pieces on roll; stretchable 5 - 5.2 mm; plain; snap-on type; blue



Артикул №: 2009-115/000-007
WMB-Inline; for Smart Printer; 1500 pieces on roll; stretchable 5 - 5.2 mm; plain; snap-on type; gray



Артикул №: 2009-115/000-012
WMB-Inline; for Smart Printer; 1500 pieces on roll; stretchable 5 - 5.2 mm; plain; snap-on type; orange

















Артикул №: 2009-115/000-017
WMB-Inline; for Smart Printer; 1500 pieces on roll; stretchable 5 - 5.2 mm; plain; snap-on type; light green



Артикул №: 2009-115/000-023
WMB-Inline; for Smart Printer; 1500 pieces on roll; stretchable 5 - 5.2 mm; plain; snap-on type; green



Артикул №: 2009-115/000-024
WMB-Inline; for Smart Printer; 1500 pieces on roll; stretchable 5 - 5.2 mm; plain; snap-on type; violet

	Артикул №: 2009-145 Mini-WSB Inline; for Smart Printer; 1700 pieces on roll; stretchable 5 - 5.2 mm; plain; snap-on type; white
	Артикул №: 2009-145/000-002 Mini-WSB Inline; for Smart Printer; 1700 pieces on roll; stretchable 5 - 5.2 mm; plain; snap-on type; yellow
	Артикул №: 2009-145/000-005 Mini-WSB Inline; for Smart Printer; 1700 pieces on roll; stretchable 5 - 5.2 mm; plain; snap-on type; red
	Артикул №: 2009-145/000-006 Mini-WSB Inline; for Smart Printer; 1700 pieces on roll; stretchable 5 - 5.2 mm; plain; snap-on type; blue
	Артикул №: 2009-145/000-007 Mini-WSB Inline; for Smart Printer; 1700 pieces on roll; stretchable 5 - 5.2 mm; plain; snap-on type; gray
	Артикул №: 2009-145/000-012 Mini-WSB Inline; for Smart Printer; 1700 pieces on roll; stretchable 5 - 5.2 mm; plain; snap-on type; orange
	Артикул №: 2009-145/000-023 Mini-WSB Inline; for Smart Printer; 1700 pieces on roll; stretchable 5 - 5.2 mm; plain; snap-on type; green
	Артикул №: 2009-145/000-024 Mini-WSB Inline; for Smart Printer; 1700 pieces on roll; stretchable 5 - 5.2 mm; plain; snap-on type; violet
	Артикул №: 2009-191 Group marker carrier
	Артикул №: 2009-192 Group marker carrier
	Артикул №: 2009-193 Group marker carrier
	Артикул №: 2009-198 Adaptor; gray
	Артикул №: 248-501 Miniature WSB Quick marking system; plain; Marker width 5 mm; 10 strips with 10 markers per card
	Артикул №: 248-501/000-002 Mini-WSB marking card; as card; not stretchable; plain; snap-on type; yellow
	Артикул №: 248-501/000-005 Mini-WSB marking card; as card; not stretchable; plain; snap-on type; red



Артикул №: 248-501/000-006

Mini-WSB marking card; as card; not stretchable; plain; snap-on type; blue



Артикул №: 248-501/000-007

Mini-WSB marking card; as card; not stretchable; plain; snap-on type; gray



Артикул №: 248-501/000-012

Mini-WSB marking card; as card; not stretchable; plain; snap-on type; orange



Артикул №: 248-501/000-017

Mini-WSB marking card; as card; not stretchable; plain; snap-on type; light green



Артикул №: 248-501/000-023

Mini-WSB marking card; as card; not stretchable; plain; snap-on type; green



Артикул №: 248-501/000-024

Mini-WSB marking card; as card; not stretchable; plain; snap-on type; violet



Артикул №: 793-501

WMB marking card; as card; not stretchable; plain; snap-on type; white



Артикул №: 793-501/000-002

WMB marking card; as card; not stretchable; plain; snap-on type; yellow



Артикул №: 793-501/000-005

WMB marking card; as card; not stretchable; plain; snap-on type; red



Артикул №: 793-501/000-006

WMB marking card; as card; not stretchable; plain; snap-on type; blue



Артикул №: 793-501/000-007

WMB marking card; as card; not stretchable; plain; snap-on type; gray



Артикул №: 793-501/000-012

WMB marking card; as card; not stretchable; plain; snap-on type; orange



Артикул №: 793-501/000-017

WMB marking card; as card; not stretchable; plain; snap-on type; light green



Артикул №: 793-501/000-023
WMB marking card; as card; not stretchable; plain; snap-on type; green



Артикул №: 793-501/000-024
WMB marking card; as card; not stretchable; plain; snap-on type; violet



Артикул №: 793-5501
WMB marking card; as card; for terminal block width 5 - 17.5 mm; stretchable 5 - 5.2 mm; plain; snap-on type; white



Артикул №: 793-5501/000-002
WMB marking card; as card; for terminal block width 5 - 17.5 mm; stretchable 5 - 5.2 mm; plain; snap-on type; yellow



Артикул №: 793-5501/000-005
WMB marking card; as card; for terminal block width 5 - 17.5 mm; stretchable 5 - 5.2 mm; plain; snap-on type; red



Артикул №: 793-5501/000-006
WMB marking card; as card; for terminal block width 5 - 17.5 mm; stretchable 5 - 5.2 mm; plain; snap-on type; blue



Артикул №: 793-5501/000-007
WMB marking card; as card; for terminal block width 5 - 17.5 mm; stretchable 5 - 5.2 mm; plain; snap-on type; gray



Артикул №: 793-5501/000-012
WMB marking card; as card; for terminal block width 5 - 17.5 mm; stretchable 5 - 5.2 mm; plain; snap-on type; orange



Артикул №: 793-5501/000-014
WMB marking card; as card; for terminal block width 5 - 17.5 mm; stretchable 5 - 5.2 mm; plain; snap-on type; brown



Артикул №: 793-5501/000-017
WMB marking card; as card; for terminal block width 5 - 17.5 mm; stretchable 5 - 5.2 mm; plain; snap-on type; green



Артикул №: 793-5501/000-023
WMB marking card; as card; for terminal block width 5 - 17.5 mm; stretchable 5 - 5.2 mm; plain; snap-on type; light green



Артикул №: 793-5501/000-024
WMB marking card; as card; for terminal block width 5 - 17.5 mm; stretchable 5 - 5.2 mm; plain; snap-on type; violet