

# Standard Rectifier Module

<b>3~ Rectifier</b>	
$V_{RRM}$	= 1200 V
$I_{DAV}$	= 175 A
$I_{FSM}$	= 1800 A

## 3~ Rectifier Bridge

Part number

**VUO160-12NO7**

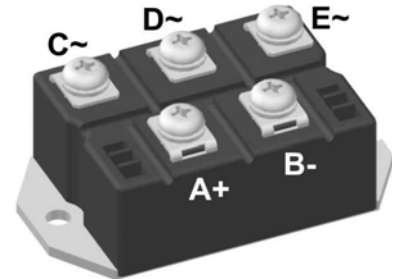

E72873

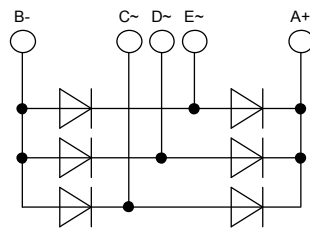

### Features / Advantages:

- Package with DCB ceramic
- Improved temperature and power cycling
- Planar passivated chips
- Very low forward voltage drop
- Very low leakage current

### Applications:

- Diode for main rectification
- For three phase bridge configurations
- Supplies for DC power equipment
- Input rectifiers for PWM inverter
- Battery DC power supplies
- Field supply for DC motors

### Package: PWS-E

- Industry standard outline
- RoHS compliant
- Easy to mount with two screws
- Base plate: Copper internally DCB isolated
- Advanced power cycling

Rectifier				Ratings				
Symbol	Definition	Conditions		min.	typ.	max.	Unit	
$V_{RSM}$	max. non-repetitive reverse blocking voltage					1300	V	
$V_{RRM}$	max. repetitive reverse blocking voltage					1200	V	
$I_R$	reverse current	$V_R = 1200$ V	$T_{VJ} = 25^\circ\text{C}$			200	$\mu\text{A}$	
		$V_R = 1200$ V	$T_{VJ} = 150^\circ\text{C}$			2	mA	
$V_F$	forward voltage drop	$I_F = 60$ A	$T_{VJ} = 25^\circ\text{C}$			1.10	V	
		$I_F = 180$ A				1.40	V	
		$I_F = 60$ A	$T_{VJ} = 125^\circ\text{C}$			1.00	V	
		$I_F = 180$ A				1.39	V	
$I_{DAV}$	bridge output current	$T_C = 110^\circ\text{C}$ rectangular	$T_{VJ} = 150^\circ\text{C}$ $d = \frac{1}{3}$			175	A	
$V_{FO}$	threshold voltage	} for power loss calculation only				0.77	V	
$r_F$	slope resistance					3.4	m $\Omega$	
$R_{thJC}$	thermal resistance junction to case					0.5	K/W	
$R_{thCH}$	thermal resistance case to heatsink			0.2			K/W	
$P_{tot}$	total power dissipation			$T_C = 25^\circ\text{C}$			250	W
$I_{FSM}$	max. forward surge current	$t = 10$ ms; (50 Hz), sine	$T_{VJ} = 45^\circ\text{C}$			1.80	kA	
		$t = 8,3$ ms; (60 Hz), sine	$V_R = 0$ V			1.95	kA	
		$t = 10$ ms; (50 Hz), sine	$T_{VJ} = 150^\circ\text{C}$			1.53	kA	
		$t = 8,3$ ms; (60 Hz), sine	$V_R = 0$ V			1.65	kA	
$I^2t$	value for fusing	$t = 10$ ms; (50 Hz), sine	$T_{VJ} = 45^\circ\text{C}$			16.2	kA <sup>2</sup> s	
		$t = 8,3$ ms; (60 Hz), sine	$V_R = 0$ V			15.7	kA <sup>2</sup> s	
		$t = 10$ ms; (50 Hz), sine	$T_{VJ} = 150^\circ\text{C}$			11.7	kA <sup>2</sup> s	
		$t = 8,3$ ms; (60 Hz), sine	$V_R = 0$ V			11.3	kA <sup>2</sup> s	
$C_J$	junction capacitance	$V_R = 400$ V; $f = 1$ MHz		$T_{VJ} = 25^\circ\text{C}$		35	pF	

Package PWS-E			Ratings			
Symbol	Definition	Conditions	min.	typ.	max.	Unit
$I_{RMS}$	RMS current	per terminal			200	A
$T_{stg}$	storage temperature		-40		125	°C
$T_{VJ}$	virtual junction temperature		-40		150	°C
<b>Weight</b>				284		g
$M_D$	mounting torque		4.25		5.75	Nm
$M_T$	terminal torque		4.25		5.75	Nm
$d_{Spp/App}$	creepage distance on surface   striking distance through air	terminal to terminal	12.0			mm
$d_{Spt/Apb}$		terminal to backside	26.0			mm
$V_{ISOL}$	isolation voltage	t = 1 second	3000			V
		t = 1 minute	2500			V

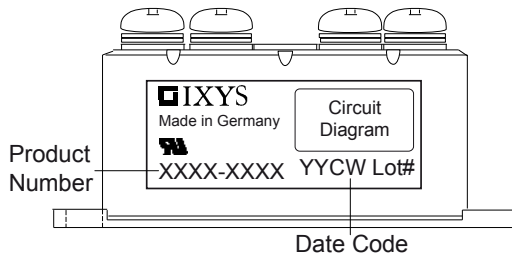

Ordering	Part Number	Marking on Product	Delivery Mode	Quantity	Code No.
Standard	VUO160-12NO7	VUO160-12NO7	Box	5	462446

### Equivalent Circuits for Simulation

\* on die level

$T_{VJ} = 150\text{ °C}$



Rectifier

$V_{0\text{ max}}$	threshold voltage	0.77	V
$R_{0\text{ max}}$	slope resistance *	2.2	mΩ

**Outlines PWS-E**

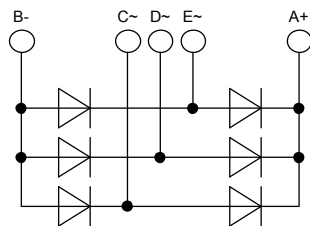
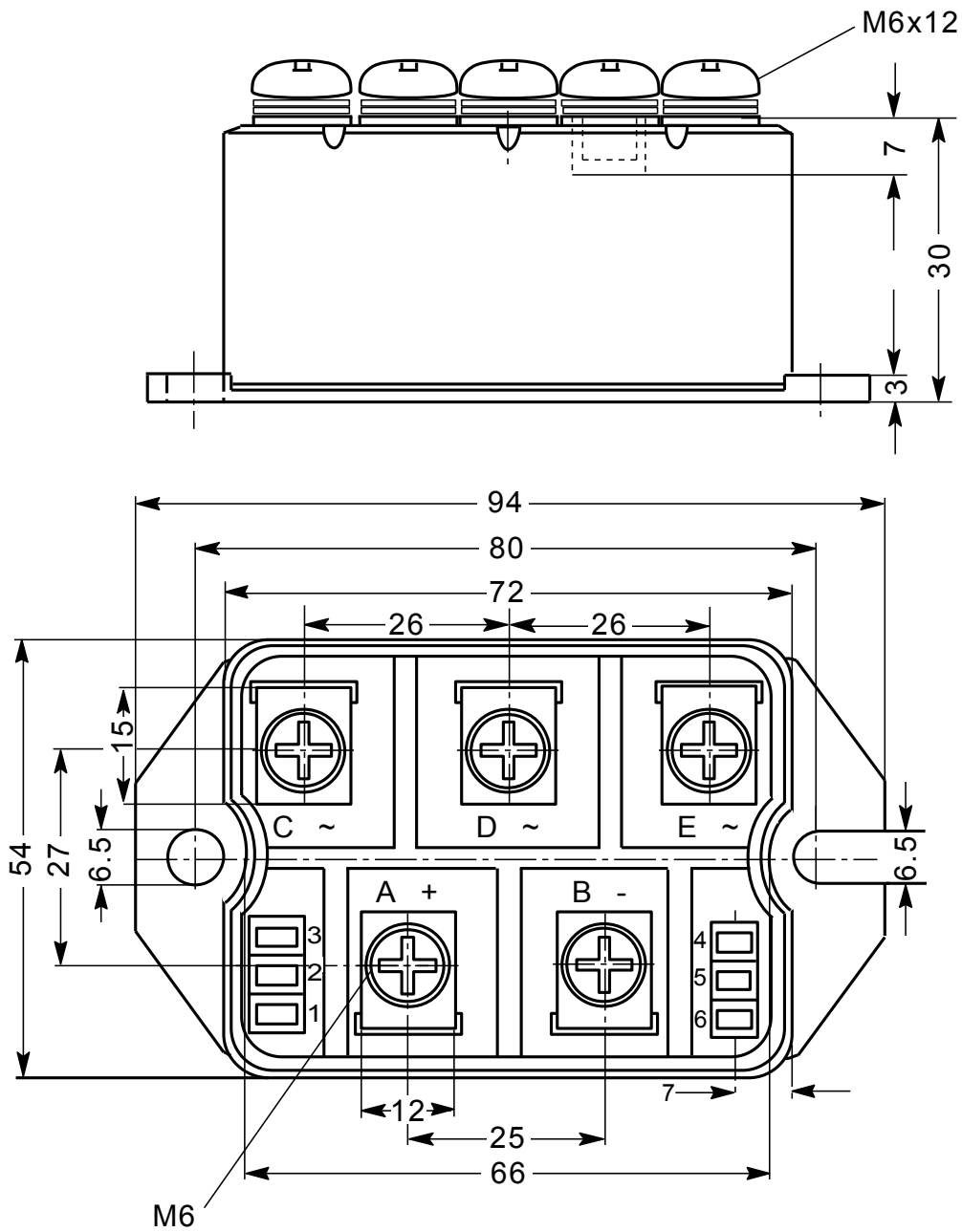

## Rectifier

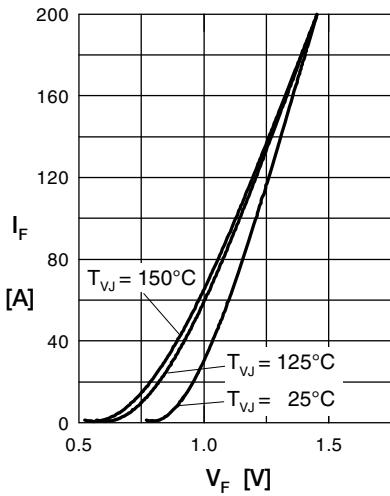

Fig. 1 Forward current vs. voltage drop per diode

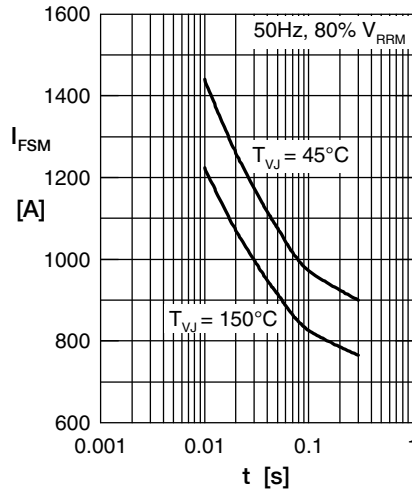

Fig. 2 Surge overload current vs. time per diode

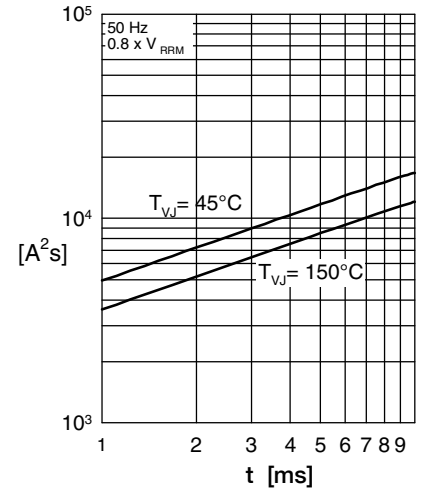

Fig. 3  $I^2t$  vs. time per diode

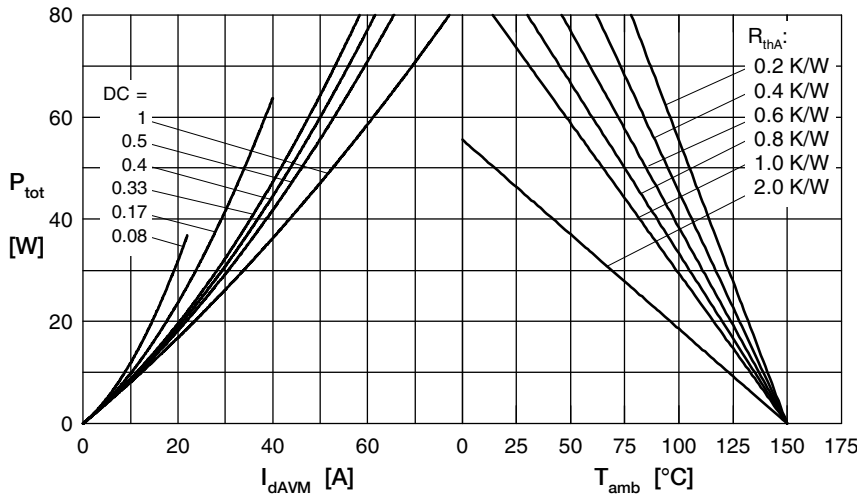

Fig. 4 Power dissipation vs. forward current and ambient temperature per diode

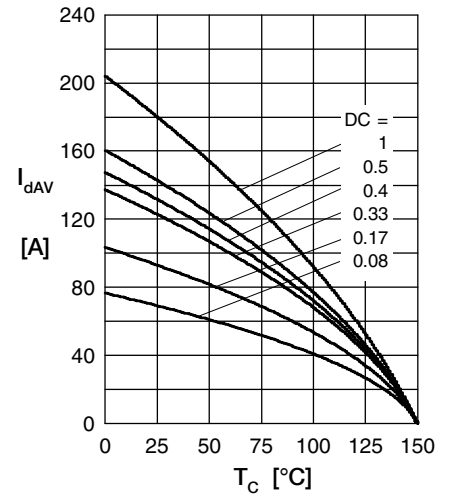

Fig. 5 Max. forward current vs. case temperature per diode

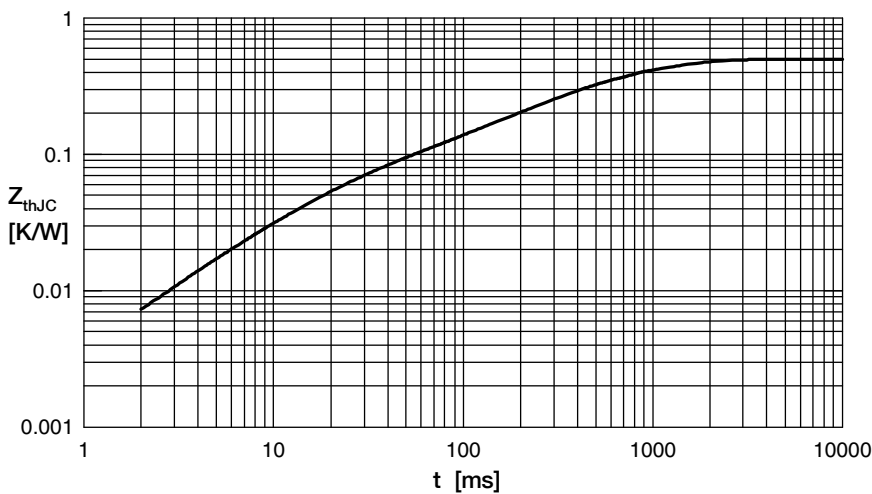

Fig. 6 Transient thermal impedance junction to case vs. time per diode

$R_i$	$t_i$
0.050	0.02
0.003	0.01
0.120	0.225
0.217	0.8
0.110	0.58