



Standard Recovery Diodes, (Stud Version), 85 A



DO-5 (DO-203AB)

FEATURES

- High surge current capability
- Stud cathode and stud anode version
- Leaded version available
- Types up to 1600 V V_{RRM}
- Designed and qualified for industrial level
- Material categorization: for definitions of compliance please see www.vishay.com/doc?99912



RoHS
COMPLIANT

TYPICAL APPLICATIONS

- Battery chargers
- Converters
- Power supplies
- Machine tool controls
- Welding

PRIMARY CHARACTERISTICS	
$I_{F(AV)}$	85 A
Package	DO-5 (DO-203AB)
Circuit configuration	Single

MAJOR RATINGS AND CHARACTERISTICS				
PARAMETER	TEST CONDITIONS	85HF(R)		UNITS
		10 to 120	140 to 160	
$I_{F(AV)}$		85	85	A
	T_C	140	110	°C
$I_{F(RMS)}$		133	133	A
I_{FSM}	50 Hz	1700	1700	A
	60 Hz	1800	1800	
I^2t	50 Hz	14 500	14 500	A ² s
	60 Hz	13 500	13 500	
V_{RRM}	Range	100 to 1200	1400 to 1600	V
T_J		-65 to +180	-65 to +150	°C

ELECTRICAL SPECIFICATIONS

VOLTAGE RATINGS				
TYPE NUMBER	VOLTAGE CODE	V_{RRM} , MAXIMUM REPETITIVE PEAK REVERSE VOLTAGE V	V_{RSM} , MAXIMUM NON-REPETITIVE PEAK REVERSE VOLTAGE V	I_{RRM} MAXIMUM AT $T_J = T_J$ MAXIMUM mA
VS-85HF(R) VS-86HF(R) VS-87HF(R) VS-88HF(R)	10	100	200	9
	20	200	300	
	40	400	500	
	60	600	700	
	80	800	900	
	100	1000	1100	
	120	1200	1300	
	140	1400	1500	
	160	1600	1700	4.5



FORWARD CONDUCTION							
PARAMETER	SYMBOL	TEST CONDITIONS		85HF(R)		UNITS	
				10 to 120	140/160		
Maximum average forward current at case temperature	$I_{F(AV)}$	180° conduction, half sine wave		85		A	
				140	110	°C	
Maximum RMS forward current	$I_{F(RMS)}$			133		A	
Maximum peak, one-cycle forward, non-repetitive surge current	I_{FSM}	t = 10 ms	No voltage reapplied	Sinusoidal half wave, initial $T_J = T_J$ maximum		1700	A
		t = 8.3 ms					
		t = 10 ms	100 % V_{RRM} reapplied			1800	
		t = 8.3 ms				1450	
Maximum I^2t for fusing	I^2t	t = 10 ms	No voltage reapplied	14 500	A ² s		
		t = 8.3 ms					
		t = 10 ms	100 % V_{RRM} reapplied	13 500			
		t = 8.3 ms		10 500			
Maximum $I^2\sqrt{t}$ for fusing	$I^2\sqrt{t}$	t = 0.1 ms to 10 ms, no voltage reapplied		16 000	A ² √s		
Value of threshold voltage (up to 1200 V)	$V_{F(TO)}$	$T_J = T_J$ maximum		0.68		V	
Value of threshold voltage (for 1400 V, 1600 V)				0.69			
Value of forward slope resistance (up to 1200 V)	r_f	$T_J = T_J$ maximum		1.62		mW	
Value of forward slope resistance (for 1400 V, 1600 V)				1.75			
Maximum forward voltage drop	V_{FM}	$I_{pk} = 267$ A, $T_J = 25$ °C, $t_p = 400$ μs rectangular wave		1.2	1.4	V	

THERMAL AND MECHANICAL SPECIFICATIONS						
PARAMETER	SYMBOL	TEST CONDITIONS		85HF(R)		UNITS
				10 to 20	140 to 160	
Maximum junction operating and storage temperature range	T_J, T_{Stg}			-65 to +180	-65 to +150	°C
Maximum thermal resistance, junction to case	R_{thJC}	DC operation		0.35		K/W
Maximum thermal resistance, case to heatsink	R_{thCS}	Mounting surface, smooth, flat and greased		0.25		
Maximum shock ⁽¹⁾				1500		g
Maximum constant vibration ⁽¹⁾		50 Hz		20		
Maximum constant acceleration ⁽¹⁾		Stud outwards		5000		
Maximum allowable mounting torque + 0 %, - 10 %		Not lubricated thread, tightening on nut		3.4 (30)		N · m (lbf · in)
		Lubricated thread, tightening on nut		2.3 (20)		
		Not lubricated thread, tightening on hexagon		4.2 (37)		
		Lubricated thread, tightening on hexagon		3.2 (28)		
Approximate weight		Unleaded device		17		g
				0.6		oz.
Case style		See dimensions - link at the end of datasheet		DO-5 (DO-203AB)		

Notes

- ⁽¹⁾ Available only for 88HF
- ⁽²⁾ Recommended for pass-through holes
- ⁽³⁾ Recommended for holed threaded heatsinks



ΔR_{thJC} CONDUCTION				
CONDUCTION ANGLE	SINUSOIDAL CONDUCTION	RECTANGULAR CONDUCTION	TEST CONDITIONS	UNITS
180°	0.10	0.08	T _J = T _J maximum	K/W
120°	0.11	0.11		
90°	0.13	0.13		
60°	0.17	0.17		
30°	0.26	0.26		

Note

- The table above shows the increment of thermal resistance R_{thJC} when devices operate at different conduction angles than DC

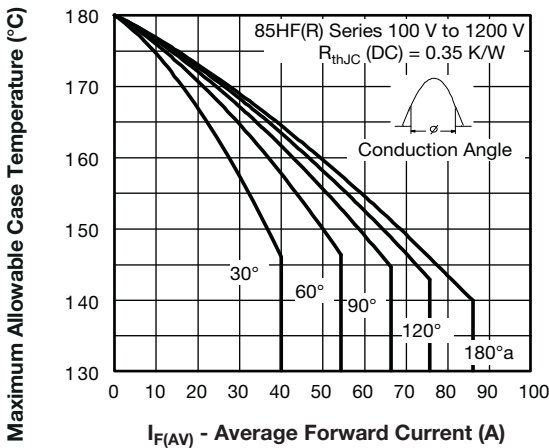

Fig. 1 - Current Ratings Characteristics

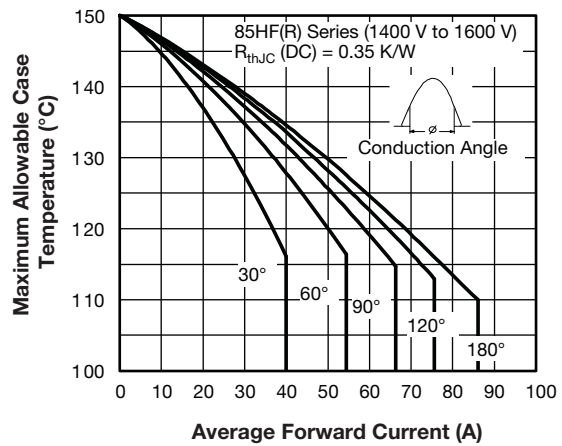

Fig. 3 - Current Ratings Characteristics

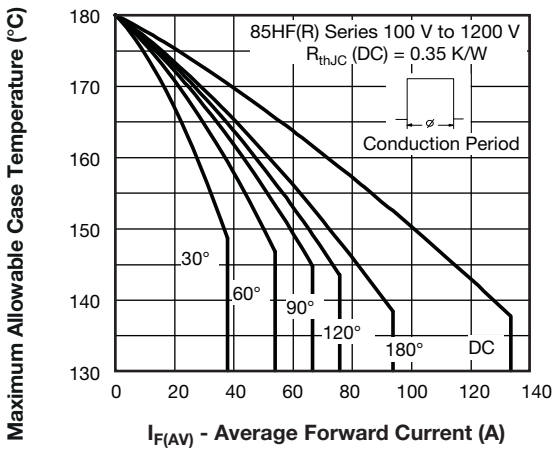

Fig. 2 - Current Ratings Characteristics

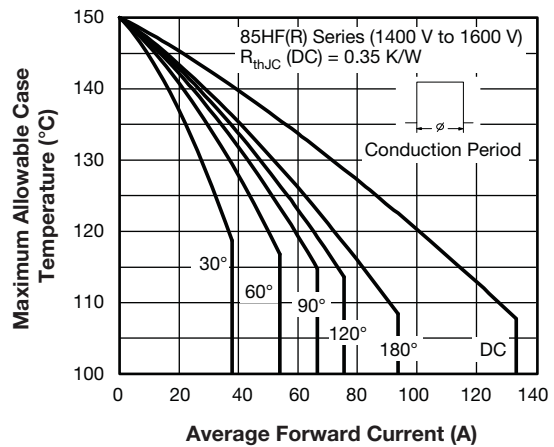

Fig. 4 - Current Ratings Characteristics



VS-85HF(R), VS-86HF(R), VS-87HF(R), VS-88HF(R) Series

www.vishay.com

Vishay Semiconductors

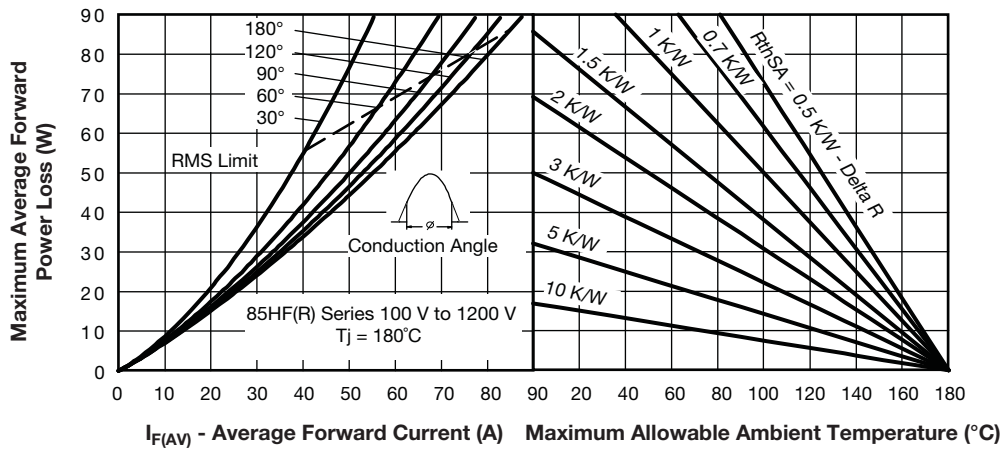

Fig. 5 - Forward Power Loss Characteristics

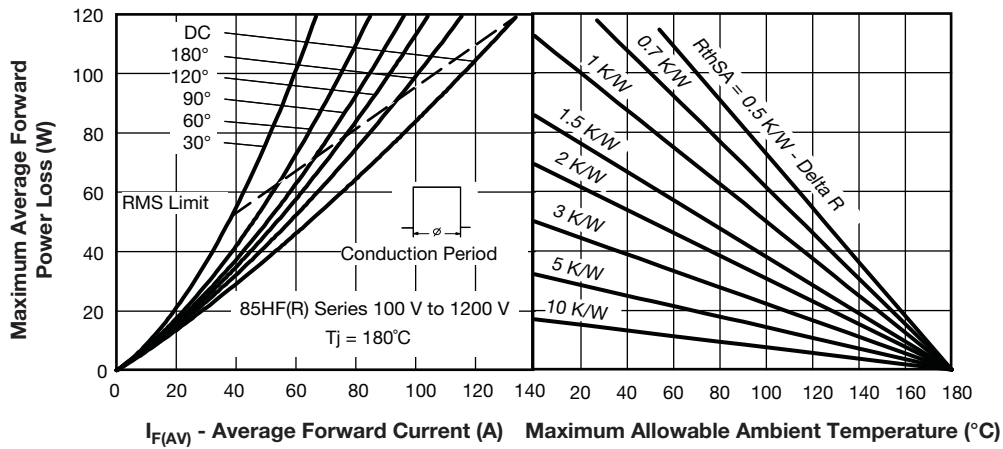

Fig. 6 - Forward Power Loss Characteristics

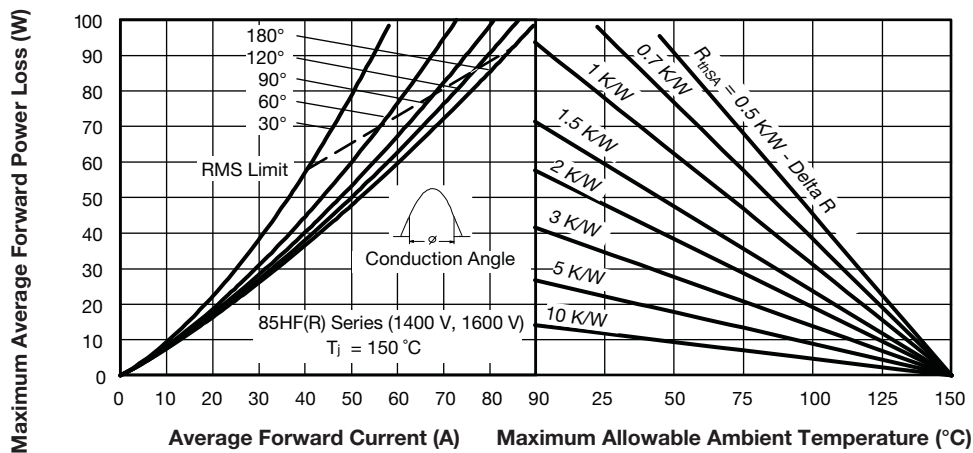

Fig. 7 - Forward Power Loss Characteristics

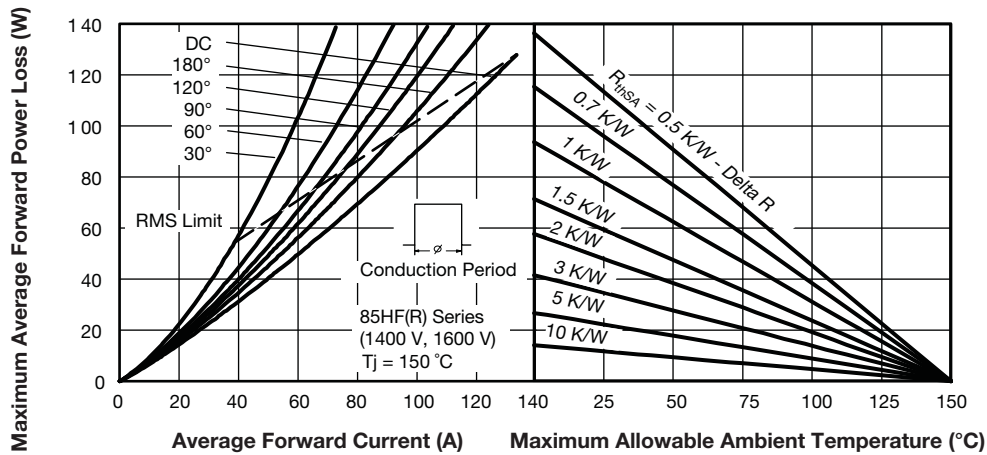

Fig. 8 - Forward Power Loss Characteristics

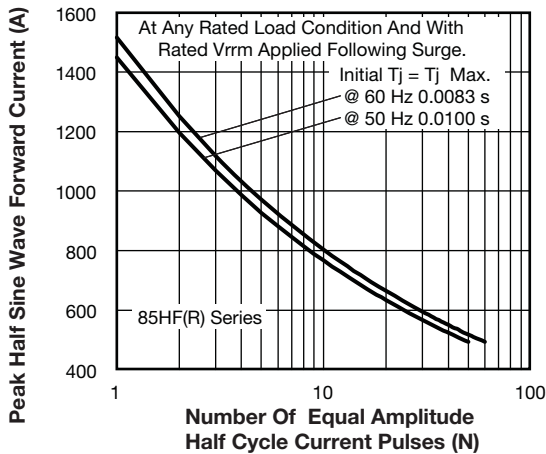

Fig. 9 - Maximum Non-Repetitive Surge Current

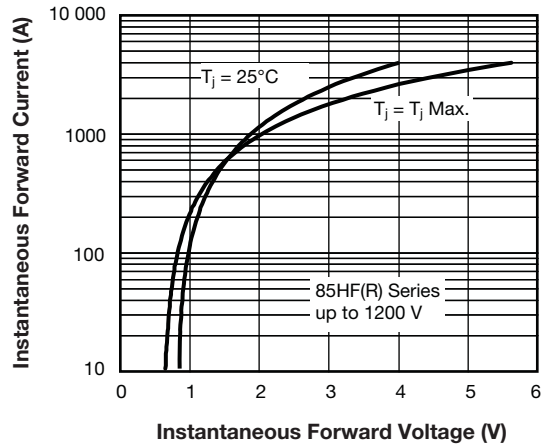

Fig. 11 - Forward Voltage Drop Characteristics

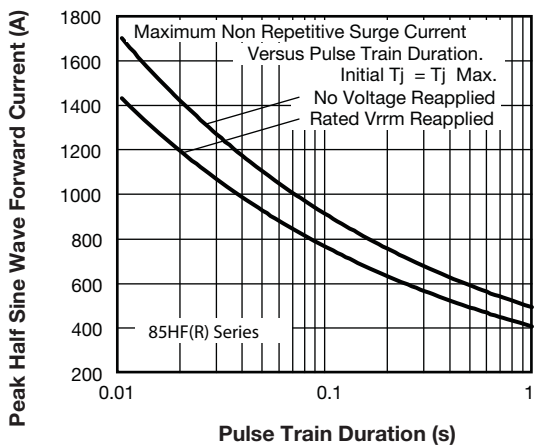

Fig. 10 - Maximum Non-Repetitive Surge Current

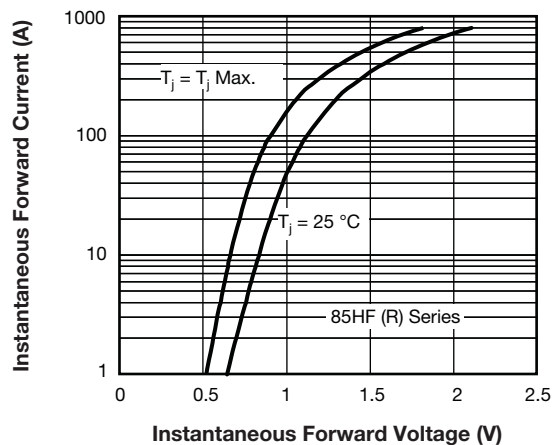

Fig. 12 - Forward Voltage Drop Characteristics (for 1400 V, 1600 V)

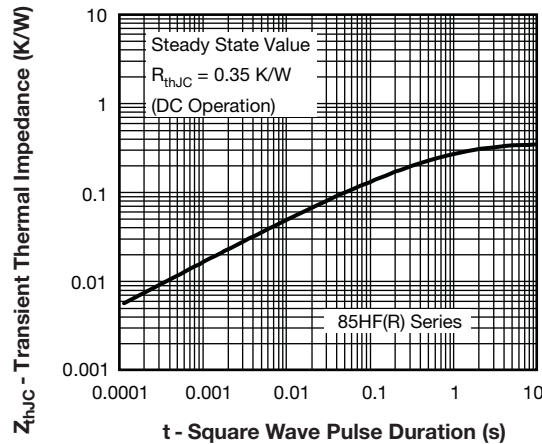

Fig. 13 - Thermal Impedance Z_{thJC} Characteristics

ORDERING INFORMATION TABLE

Device code	VS-	85	HF	R	160	M
	①	②	③	④	⑤	⑥

- 1** - Vishay Semiconductors product
- 2** - 85 = standard device
86 = not isolated lead
87 = isolated lead with silicone sleeve
(red = Reverse polarity)
(blue = Normal polarity)
88 = type for rotating application
- 3** - HF = standard diode
- 4** - None = stud normal polarity (cathode to stud)
R = stud reverse polarity (anode to stud)
- 5** - Voltage code x 10 = V_{RRM} (see Voltage Ratings table)
- 6** - None = stud base DO-5 (DO-203AB) 1/4" 28UNF-2A
M = stud base DO-5 (DO-203AB) M6 x 1 (not available for 88HF)
M8 = stud base DO-5 (DO-203AB) M8 x 1.25 (not available for 88HF)

LINKS TO RELATED DOCUMENTS	
Dimensions	www.vishay.com/doc?95342



DO-5 (DO-203AB) for 85HF(R), 86HF(R) and 88HF(R) Series

DIMENSIONS FOR 85HF(R) SERIES in millimeters (inches)

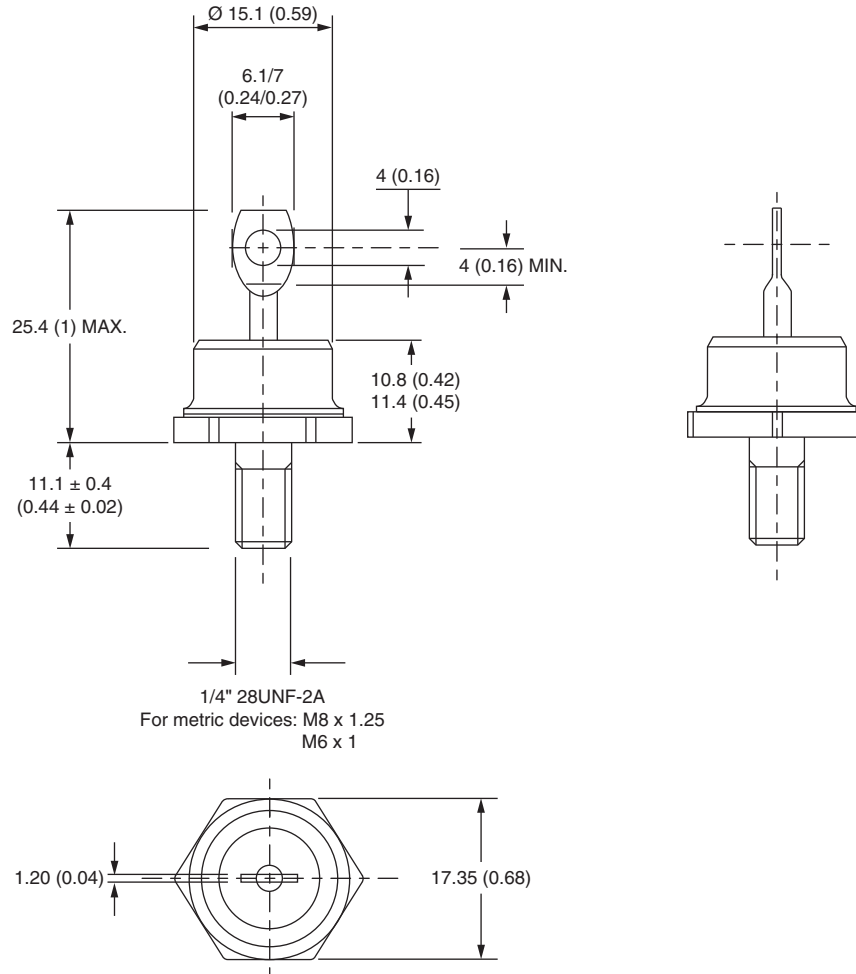



DIMENSIONS FOR 86HF(R) SERIES in millimeters (inches)

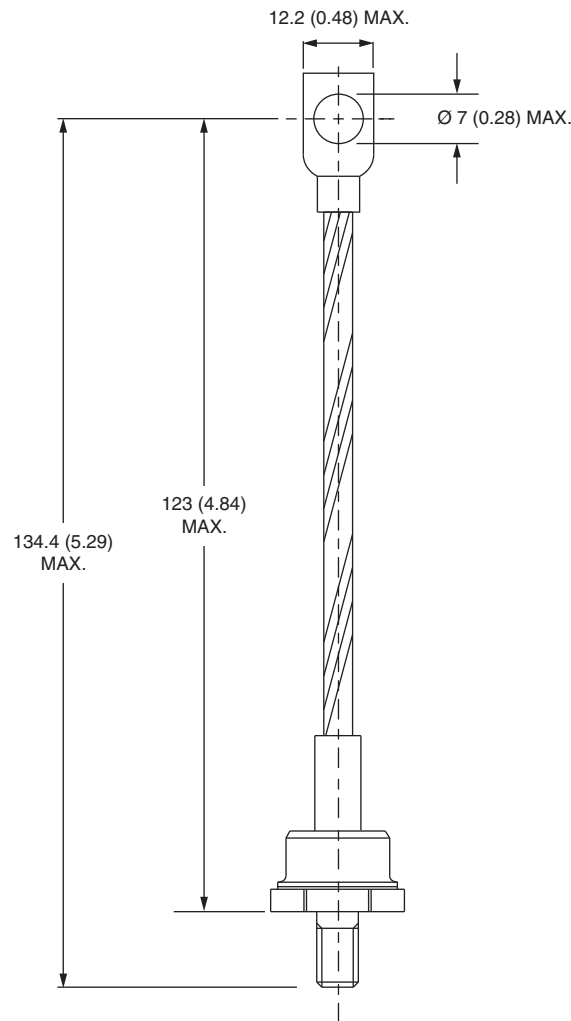



DIMENSIONS 88HF(R) SERIES in millimeters (inches)

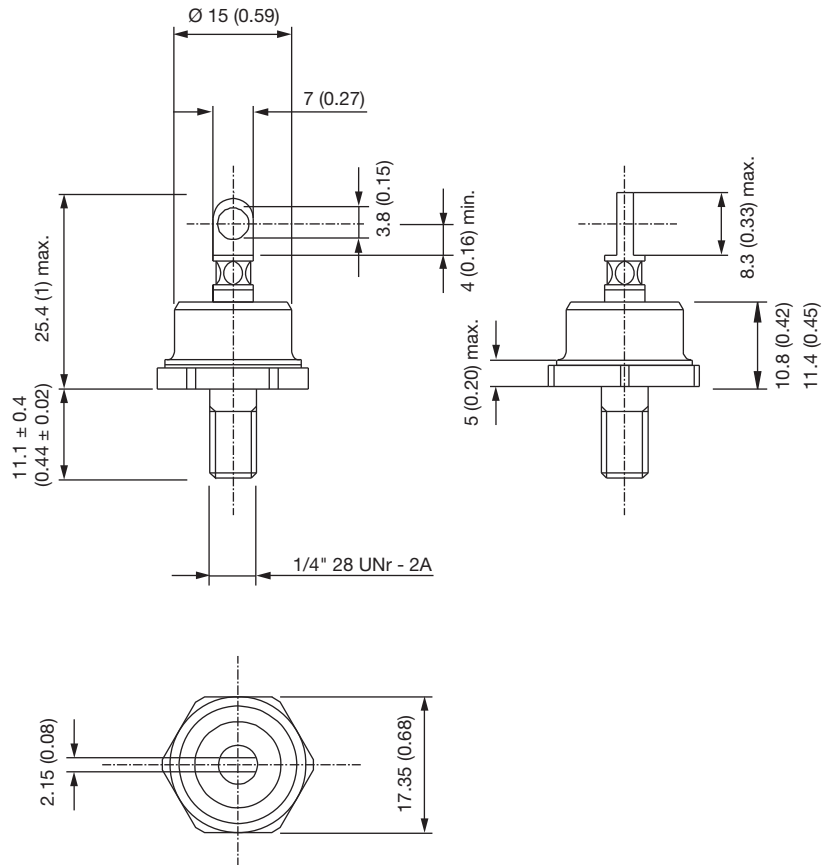



Disclaimer

ALL PRODUCT, PRODUCT SPECIFICATIONS AND DATA ARE SUBJECT TO CHANGE WITHOUT NOTICE TO IMPROVE RELIABILITY, FUNCTION OR DESIGN OR OTHERWISE.

Vishay Intertechnology, Inc., its affiliates, agents, and employees, and all persons acting on its or their behalf (collectively, "Vishay"), disclaim any and all liability for any errors, inaccuracies or incompleteness contained in any datasheet or in any other disclosure relating to any product.

Vishay makes no warranty, representation or guarantee regarding the suitability of the products for any particular purpose or the continuing production of any product. To the maximum extent permitted by applicable law, Vishay disclaims (i) any and all liability arising out of the application or use of any product, (ii) any and all liability, including without limitation special, consequential or incidental damages, and (iii) any and all implied warranties, including warranties of fitness for particular purpose, non-infringement and merchantability.

Statements regarding the suitability of products for certain types of applications are based on Vishay's knowledge of typical requirements that are often placed on Vishay products in generic applications. Such statements are not binding statements about the suitability of products for a particular application. It is the customer's responsibility to validate that a particular product with the properties described in the product specification is suitable for use in a particular application. Parameters provided in datasheets and / or specifications may vary in different applications and performance may vary over time. All operating parameters, including typical parameters, must be validated for each customer application by the customer's technical experts. Product specifications do not expand or otherwise modify Vishay's terms and conditions of purchase, including but not limited to the warranty expressed therein.

Except as expressly indicated in writing, Vishay products are not designed for use in medical, life-saving, or life-sustaining applications or for any other application in which the failure of the Vishay product could result in personal injury or death. Customers using or selling Vishay products not expressly indicated for use in such applications do so at their own risk. Please contact authorized Vishay personnel to obtain written terms and conditions regarding products designed for such applications.

No license, express or implied, by estoppel or otherwise, to any intellectual property rights is granted by this document or by any conduct of Vishay. Product names and markings noted herein may be trademarks of their respective owners.