

## Standard Rectifier

1~ Rectifier	
$V_{RRM}$	= 1200 V
$I_{DAV}$	= 20 A
$I_{FSM}$	= 150 A

### 1~ Rectifier Bridge

Part number

FBO16-12N

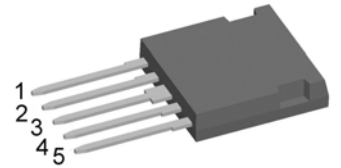

Backside: isolated

 E72873

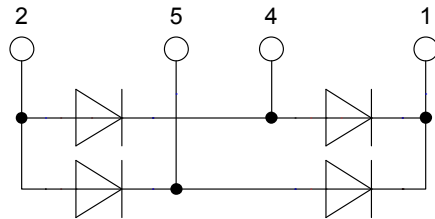

#### Features / Advantages:

- Planar passivated chips
- Very low leakage current
- Very low forward voltage drop
- Improved thermal behaviour

#### Applications:

- Diode Bridge for main rectification

#### Package: i4-Pac

- Isolation Voltage: 3000V~
- Industry convenient outline
- RoHS compliant
- Epoxy meets UL 94V-0
- Soldering pins for PCB mounting
- Backside: DCB ceramic
- Reduced weight
- Advanced power cycling

Rectifier				Ratings				
Symbol	Definition	Conditions		min.	typ.	max.	Unit	
$V_{RSM}$	max. non-repetitive reverse blocking voltage					1300	V	
$V_{RRM}$	max. repetitive reverse blocking voltage					1200	V	
$I_R$	reverse current, drain current	$V_R = 1200\text{ V}$	$T_{VJ} = 25^\circ\text{C}$			10	$\mu\text{A}$	
		$V_R = 1200\text{ V}$	$T_{VJ} = 150^\circ\text{C}$			1	mA	
$V_F$	forward voltage drop	$I_F = 10\text{ A}$	$T_{VJ} = 25^\circ\text{C}$			1.21	V	
						1.43	V	
		$I_F = 20\text{ A}$	$T_{VJ} = 150^\circ\text{C}$			1.14	V	
						1.45	V	
$I_{DAV}$	bridge output current	$T_C = 130^\circ\text{C}$ rectangular	$T_{VJ} = 175^\circ\text{C}$			20	A	
								d = 0.5
$V_{FO}$	threshold voltage					0.81	V	
$r_F$	slope resistance					32	m $\Omega$	
		} for power loss calculation only						
$R_{thJC}$	thermal resistance junction to case					3	K/W	
$R_{thCH}$	thermal resistance case to heatsink				0.20		K/W	
$P_{tot}$	total power dissipation			$T_C = 25^\circ\text{C}$		50	W	
$I_{FSM}$	max. forward surge current	t = 10 ms; (50 Hz), sine	$T_{VJ} = 45^\circ\text{C}$			150	A	
								t = 8,3 ms; (60 Hz), sine
		t = 10 ms; (50 Hz), sine	$T_{VJ} = 150^\circ\text{C}$				130	A
$I^2t$	value for fusing	t = 10 ms; (50 Hz), sine	$T_{VJ} = 45^\circ\text{C}$			115	A <sup>2</sup> s	
								t = 8,3 ms; (60 Hz), sine
		t = 10 ms; (50 Hz), sine	$T_{VJ} = 150^\circ\text{C}$				85	A <sup>2</sup> s
$C_J$	junction capacitance	$V_R = 400\text{ V}; f = 1\text{ MHz}$		$T_{VJ} = 25^\circ\text{C}$		4	pF	

Package i4-Pac		Ratings				
Symbol	Definition	Conditions	min.	typ.	max.	Unit
$I_{RMS}$	RMS current	per terminal			35	A
$T_{stg}$	storage temperature		-55		150	°C
$T_{VJ}$	virtual junction temperature		-55		175	°C
<b>Weight</b>				9		g
$F_C$	mounting force with clip		20		120	N
$d_{Spp/App}$	creepage distance on surface   striking distance through air	terminal to terminal	1.7			mm
$d_{Spb/Apb}$		terminal to backside	5.1			mm
$V_{ISOL}$	isolation voltage	t = 1 second	3000			V
		t = 1 minute	2500			V

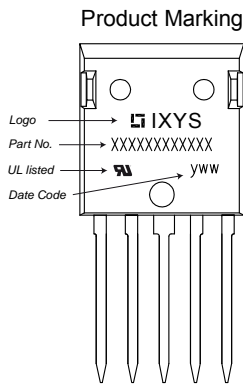

Ordering	Part Number	Marking on Product	Delivery Mode	Quantity	Code No.
Standard	FBO16-12N	FBO16-12N	Tube	25	492310

### Equivalent Circuits for Simulation

\* on die level

$T_{VJ} = 175^{\circ}C$



Rectifier

$V_{0\ max}$	threshold voltage	0.81	V
$R_{0\ max}$	slope resistance *	29	mΩ

## Outlines i4-Pac

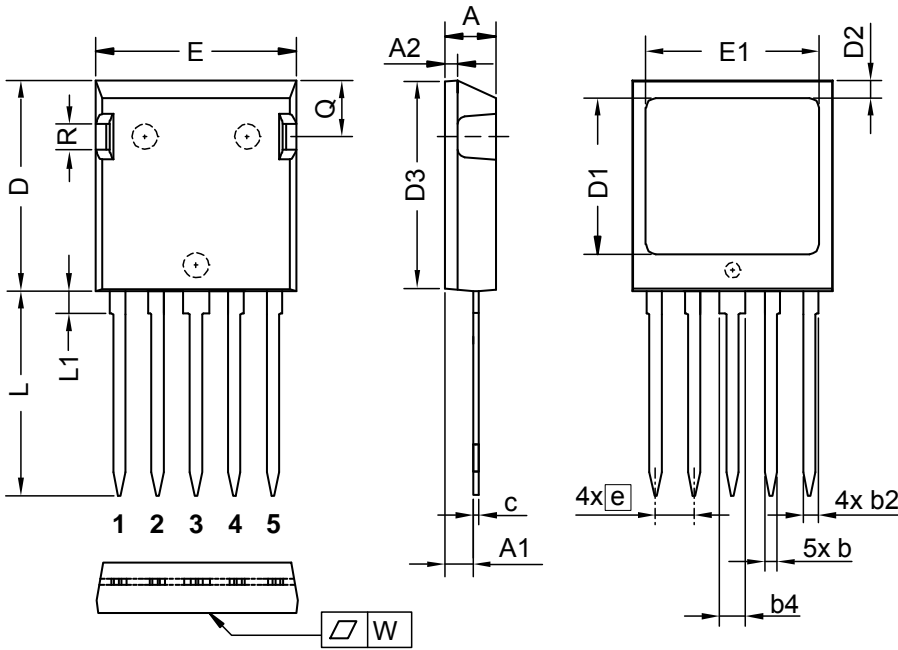

Dim.	Millimeter		Inches	
	min	max	min	max
A	4.83	5.21	0.190	0.205
A1	2.59	3.00	0.102	0.118
A2	1.17	2.16	0.046	0.085
b	1.14	1.40	0.045	0.055
b2	1.47	1.73	0.058	0.068
b4	2.54	2.79	0.100	0.110
c	0.51	0.74	0.020	0.029
D	20.80	21.34	0.819	0.840
D1	14.99	15.75	0.590	0.620
D2	1.65	2.03	0.065	0.080
D3	20.30	20.70	0.799	0.815
E	19.56	20.29	0.770	0.799
E1	16.76	17.53	0.660	0.690
e	3.81 BSC		0.150 BSC	
L	19.81	21.34	0.780	0.840
L1	2.11	2.59	0.083	0.102
Q	5.33	6.20	0.210	0.244
R	2.54	4.57	0.100	0.180
W	-	0.10	-	0.004

Die konvexe Form des Substrates ist typ. < 0.05 mm über der Kunststoffoberfläche der Bauteilunterseite  
 The convexbow of substrate is typ. < 0.05 mm over plastic surface level of device bottom side

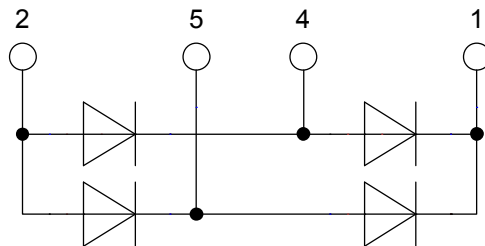

## Rectifier

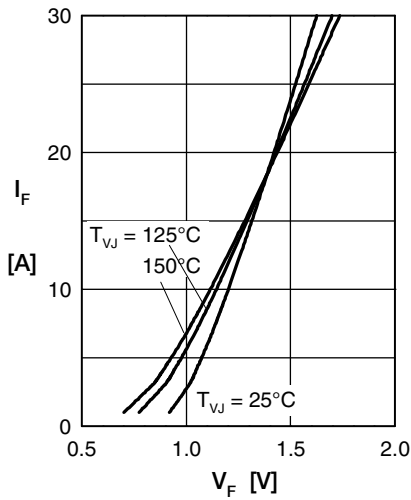

Fig. 1 Forward current versus voltage drop per diode

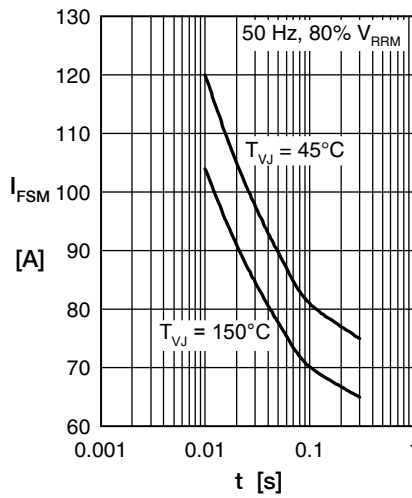

Fig. 2 Surge overload current

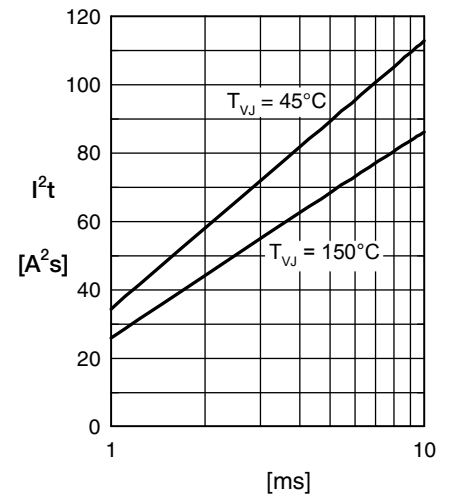

Fig. 3  $I^2t$  versus time per diode

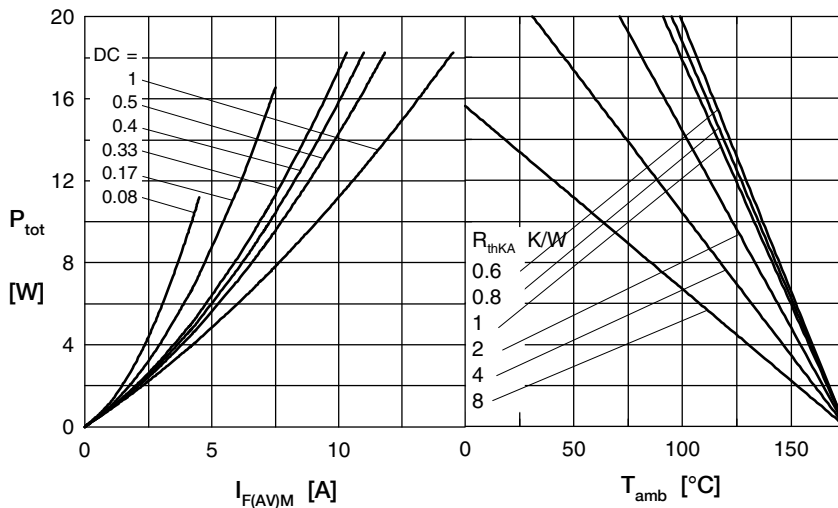

Fig. 4 Power dissipation vs. direct output current & ambient temperature

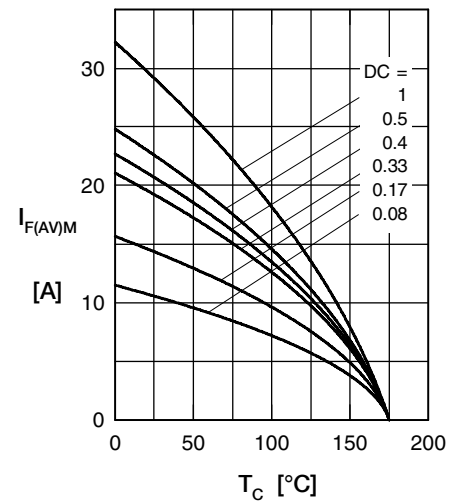

Fig. 5 Max. forward current vs. case temperature

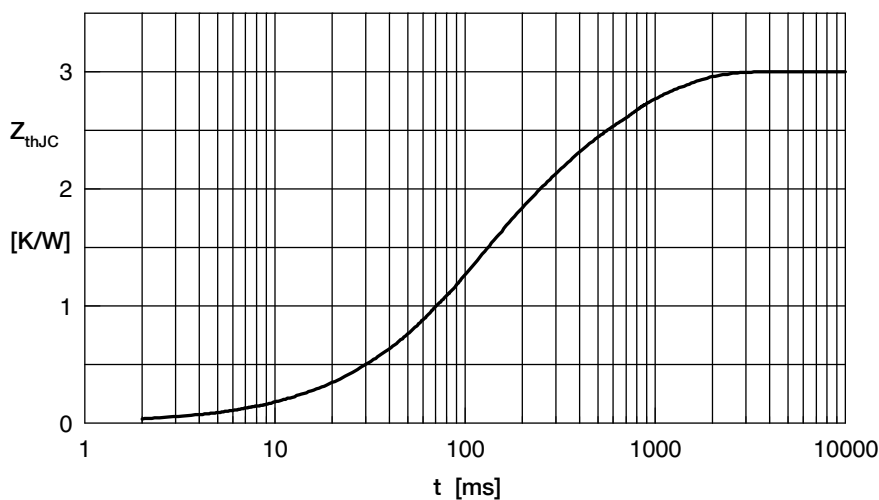

Fig. 6 Transient thermal impedance junction to case

Constants for  $Z_{thJC}$  calculation:

i	$R_{thi}$ (K/W)	$t_i$ (s)
1	1.359	0.1015
2	0.3286	0.1026
3	0.4651	0.4919
4	0.8473	0.62