

Detecting Devices



	Price Groups PG 102, 121		
9/2	Introduction		
	3SE5, 3SE2 Position Switches		3SF1 AS-Interface Position Switches
9/4	General data	9/82	General data
9/13	3SE5, molded-plastic enclosures	9/84	Molded-plastic enclosures
9/17	- Enclosure width 31 mm according to EN 50047	9/86	Metal enclosures
9/21	- Enclosure width 40 mm according to EN 50041 new		<u>With Separate Actuator</u>
9/25	- Ambient temperature up to -40 °C	9/90	General data
9/27	3SE5, metal enclosures	9/91	Molded-plastic enclosures
9/31	- Enclosure width 31 mm according to EN 50047 new	9/92	Metal enclosures
9/35	- Enclosure width 40 mm according to EN 50041	9/93	Accessories
9/39	- Enclosure width 56 mm, XL new		<u>With Interlocking</u>
9/42	- Ambient temperature up to -40 °C	9/94	General data
9/44	- Compact design new	9/95	Molded-plastic enclosures
9/46	3SE5, open-type design	9/96	Metal enclosures
9/47	Accessories and spare parts		<u>Hinge switches</u>
9/50	<u>With Separate Actuator</u>	9/97	Molded-plastic enclosures
9/55	General data	9/98	Metal enclosures
9/57	3SE5, molded-plastic enclosures		
9/59	3SE5, metal enclosures		3SE6 Magnetically Operated Switches
9/60	Accessories	9/99	Magnetic monitoring systems
9/61	3SE2, molded-plastic enclosures		
9/65	<u>With Interlocking</u>		More technical information
9/67	General data		can be found at
9/68	3SE5, molded-plastic enclosures		www.siemens.com/industrial-controls/support
9/70	3SE5, metal enclosures		under Product List:
9/71	3SE5, metal enclosures		- Technical specifications
9/72	3SE2, molded-plastic enclosures		under Entry List:
9/74	<u>For Explosion Protection (ATEX)</u>		- Updates
	3SE5, metal enclosures		- Downloads
			- FAQ
			- Manuals
			- Characteristics
			- Certificates
			and at
			www.siemens.com/industrial-controls/configurators
			- Configurators

Detecting Devices

Introduction

Overview



**3SE5 23.,
3SE5 21.,
3SF1 2.4**

**3SE5 24.,
3SF1 244**

**3SE5 13.,
3SE5 11.,
3SF1 114**

**3SE5 12.,
3SF1 124**

3SE5 16.

**3SE5 232,
3SE5 212,
3SF1 2.4**

**3SE5 132,
3SE5 112,
3SF1 1.4**

	Position switches, standard					Hinge switches	
Enclosures							
Plastic	✓	✓	✓	--	--	✓	✓
Metal	✓	--	✓	✓	✓	✓	✓
Dimensions (W x H x D) in mm	31 x 68 x 33	50 x 53 x 33	40 x 78 x 38	56 x 78 x 38	56 x 100 x 38	31 x 68 x 33	40 x 78 x 38
Degree of protection	IP65, IP66/IP67	IP66/IP67	IP66/IP67	IP66/IP67	IP66/IP67	IP65, IP66/IP67	IP66/IP67
Standards							
IEC 60947-5-1	Mounting and operating points acc. to EN 50047	Operating points acc. to EN 50047	Mounting and operating points acc. to EN 50041	Operating points acc. to EN 50041	Operating points acc. to EN 50047	Mounting and operating points acc. to EN 50047	Mounting and operating points acc. to EN 50041
Approvals	CE, UL, CSA, CCC		CE, UL, CSA, CCC			CE, UL, CSA, CCC	
Contact blocks							
2 slow-action contacts	1 NO + 1 NC, 2 NC		1 NO + 1 NC, 2 NC		--	1 NO + 1 NC	
2 snap-action contacts	1 NO + 1 NC		1 NO + 1 NC		--	1 NO + 1 NC	
• Short stroke	1 NO + 1 NC		✓		--	✓	
• With 2 x 2 mm contact gap	1 NO + 1 NC		✓		--	✓	
3 slow-action contacts	1 NO + 2 NC, 2 NO + 1 NC		1 NO + 2 NC, 2 NO + 1 NC		--	1 NO + 2 NC	
• With make-before-break	1 NO + 2 NC		1 NO + 2 NC		--	1 NO + 2 NC	
3 snap-action contacts	1 NO + 2 NC		1 NO + 2 NC		--	1 NO + 2 NC	
2 x (2 or 3 contacts)	--	--	--	--	✓	--	--
Special features							
LED status display	✓	✓	✓	✓	--	✓	✓
Increased corrosion protection	✓	✓	✓	✓	✓	✓	✓
Explosion protection (ATEX)	--	--	✓	✓	✓	✓	✓
ASIsafe integrated	✓	✓	✓	✓	--	✓	✓
Electrical specifications							
Insulation voltage U_i	400 V		400 V			400 V	
Conventional thermal current I_{the}	6 A/10 A (3-/2-pole)		6 A/10 A (3-/2-pole)			6 A/10 A (3-/2-pole)	
Connections							
Cable entry	1 x M20 x 1.5	2 x M20 x 1.5	1 x M20 x 1.5	3 x M20 x 1.5	1 x M20 x 1.5	1 x M20 x 1.5	1 x M20 x 1.5
M12 connector socket, 4-, 5- or 8-pole	✓	✓	✓	✓	✓	✓	✓
Connector socket, 6-pole + PE	--	--	✓	✓	--	--	--
Actuators							
Rounded plungers and roller plungers	✓	✓	✓	✓	--	--	--
Roller and angular roller levers	✓	✓	✓	✓	--	--	--
Spring rods	✓	✓	✓	✓	--	--	--
Twist levers and rod actuators	✓	✓	✓	✓	--	--	--
Fork levers	--	--	✓	✓	--	--	--
Hinge switches	--	--	--	--	✓	✓	✓
Page							
Complete units	9/13	9/21	9/31	9/35	9/39	9/70	9/71
Modular system	9/15	9/23	9/33	9/37	9/40	--	--
Ambient temperature -40 °C	9/25	9/25	9/42	9/42	--	--	--
ASIsafe	9/84	9/84	9/88	9/88	--	9/97	9/98
ATEX	9/75	--	9/78	9/78	9/79	9/77	9/81

✓ Available

-- Not available

3SE5 413,
3SE5 423

3SE5 250

3SE5 232,
3SE5 242,
3SF1 2.43SE5 112,
3SE5 122,
3SF1 1.43SE5 322,
3SE5 312,
3SF1 3.4

3SE6

	Compact design	Open-type	Position switches with separate actuator		Position switches with interlocking	Magnetically operated switches
Enclosures						
Plastic	--	✓	✓	✓	✓	✓
Metal	✓	--	✓	✓	✓	--
Dimensions (W x H x D) in mm	30 x .. x .., 40 x .. x ..	30 x 48,5 x 20	31 x 68 x 33, 50 x 53 x 33	40 x 78 x 38, 56 x 78 x 38	54 x 185 x 44	M30 x 44, 19 x 33 x 13, 25 x 88 x 13
Degree of protection	IP66/IP67	IP10 or IP20	IP65, IP66/IP67	IP66/IP67	IP66/IP67	IP67
Standards	--	Mounting and operating points acc. to EN 50047	Mounting acc. to EN 50047	Mounting acc. to EN 50041	EN 1088	Category 3 or 4 acc. to ISO 13849-1 (EN 954-1)
IEC 60947-5-1						
Approvals	CE, UL, CSA	--	CE, TÜV, UL, CSA, CCC		CE, TÜV, UL, CSA, CCC	CE, TÜV, UL, CSA
Contact blocks						
2 slow-action contacts	--	1 NO + 1 NC	1 NO + 1 NC		--	--
2 snap-action contacts	1 NO + 1 NC	1 NO + 1 NC	--		--	--
• Short stroke	--	✓				
• With 2 x 2 mm contact gap	--	✓				
3 slow-action contacts	--	1 NO + 2 NC	1 NO + 2 NC		--	--
• With make-before-break	--	1 NO + 2 NC	--		--	--
3 snap-action contacts	--	1 NO + 2 NC	--		--	--
6 slow-action contacts	--	--	--		2 x (1 NO + 2 NC)	--
Reed contacts	--	--	--		--	1 NO + 1 NC or 2 NC
Special features						
LED status display	--	--	✓		✓	--
Increased corrosion protection	--	--	✓		✓	--
Explosion protection (ATEX)	--	--	✓		--	--
ASIsafe integrated	--	--	✓		✓	--
Electrical specifications						
Insulation voltage U_i	--	400 V	400 V		400 V	--
Conventional thermal current I_{the}	--	6 A	6 A		6 A	--
Connections						
Cable entry	--	--	1 x M20 x 1.5, 2 x M20 x 1.5	1 x M20 x 1.5, 3 x M20 x 1.5	3 x M20 x 1.5	--
M12 connector socket, 4- or 5-pole	✓	--	✓	✓	✓	✓
Molded cables	✓	--	--	--	--	✓
AS-Interface	--	--	✓	✓	✓	✓ (through I/O module)
Actuators						
Plungers, twist levers	✓	✓	--		--	--
Separate actuators	--	--	✓		✓	--
Page						
Complete units	9/44	9/46	9/55	9/57	9/65, 9/66	--
Modular system	--	--	--	--	--	9/99
ASIsafe	--	--	9/91	9/92	9/95, 9/96	9/99
ATEX	--	--	9/77	9/81	--	--

✓ Available
-- Not available

Note: For safety characteristics see "Appendix" --> "Standards and approvals" --> "Overview"

3SE5, 3SE2 Position Switches

General data

Overview

The innovative SIRIUS 3SE5 position switches are modern in design, compact, modular and simple to connect. They save time and increase flexibility during installation of a whole range of switch variants. In principle it is possible to combine any enclosure with any operating mechanism, paying due consideration to the EN 50041 and EN 50047 standards where necessary.

Complete units

Popular versions of the position switches in standard enclosures are available as complete units.



3SE5 position switches with plastic and metal enclosures

Modular system

The 3SE5 series features a new modular system comprising different sizes of the basic switch and an actuator which must be ordered separately. Thanks to the modular design of the switch the user can select the right solution for his application from numerous versions and install it himself in a very short time.

An easy plug-in method enables fast replacement of the actuator heads.



Examples of selection options in the modular system

Design

All enclosure variants have an integrated chlorinated rubber diaphragm (high functional safety in cold and aggressive environments).

Enclosure sizes

The 3SE5 switches are available in five different enclosure sizes with 2 or 3 contacts and with the XL enclosure:

- Open-type position switch IP20 or IP10
- Molded-plastic enclosures according to EN 50047, 31 mm wide, IP65, 1 cable entry
- Metal enclosures according to EN 50047, 31 mm wide, IP66/IP67, 1 cable entry
- Plastic and metal enclosures according to EN 50041, 40 mm wide, IP66/IP67, 1 cable entry
- Molded-plastic enclosures, 50 mm wide, IP66/IP67, 2 cable entries
- Metal enclosures, 56 mm wide, IP66/IP67, 3 cable entries
- XL metal enclosures with 4 to 6 contacts, 56 mm wide, IP66/IP67, 3 cable entries

Enclosure versions

Various basic switches can be selected for the 3SE5 series:

- With contact blocks with two or three contacts (screw terminals) designed as slow-action or snap-action contacts; the slow-action contacts also with make-before-break
- Optional LED status display
- With mounted four- or five-pole M12 connector socket (available for the wide enclosures as an accessory for self-assembly)
- With 6-pole connector socket + PE on the metal enclosures
- Versions with increased corrosion protection
- Versions for operating temperature up to -40 °C
- Metal enclosures for explosion protection (ATEX) ([see page 9/74](#))
- AS-Interface version with integrated ASIsafe electronics for all enclosure designs ([see page 9/82](#))

Actuator variants

All operating mechanisms can be rotated around the axis in increments of 22.5° . The following actuator variants are available:

- Standard, rounded and roller plungers
- Roller and angular roller levers
- Spring rod
- Twist levers and rod actuators with twist actuator
- Fork levers with twist actuator

The actuator rollers are available with various materials and diameters.

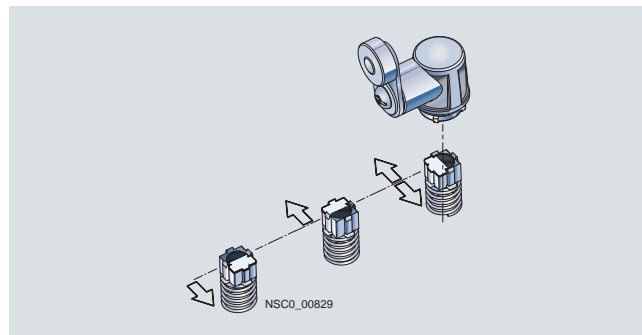

Twist actuators for twist levers and rod actuators, with setting of switching to right, left or right/left (standard for all twist actuators except fork levers)

Optional LED indicators

LED indicators
available for all enclosure sizes



The enclosure versions can be supplied with an LED signaling indicator (1 × green + 1 × yellow). This is the first time that optical signaling equipment is also available for small standard enclosures according to EN 50047. The LED signaling indicators are available in all common voltages (24 V DC and 230 V AC).

Additional contacts

Exchangeable two and three-pole contact blocks
for all enclosure sizes



The three-pole contact block with snap-action or slow-action contacts is regularly available for all enclosure forms. The same installation space is required as for a two-pole block. The version with 1 NO + 2 NC offers for example more safety through redundant shutdowns (2 NC contacts) with simultaneous signaling (1 NO contact). The three-pole blocks are also available with make-before-break and with 2 NO + 1 NC.

Contact reliability

The new switching blocks ensure an extremely high contact stability. This applies even when the devices are switching low voltages and currents, e.g. 1 mA at 5 V DC.

Positive opening \Rightarrow

The NC contacts of the switch are forced open mechanically, positively-driven and reliably by the plunger. This is referred to as "positive opening".

Mounting

Easy plug-in method
for fast replacement of the actuator heads



Open the cover (1)
Actuate the locking lever (2)
Replace the head (turnable by 16 x 22.5°) (3)
Lock and close the cover

Quick-connect technology

For molded-plastic enclosure with a width of 31 mm



These position switches can be wired quickly and easily as an added customer benefit. The connecting cable is first connected to the terminals of the contact block and then guided through a slit into the cable gland opening. The time saved through this new connection method is approx. 20 to 25 %.

A cable gland with seal must be used with the quick-connect method.

3SE5, 3SE2 Position Switches

General data

Benefits

The 3SE5 position switches differ from the previous series through the following new characteristics:

- The modular structure of the product range allows a number of versions with a smaller number of bearing types for enclosures and operating mechanisms.
- All actuators can be turned around the axis in increments of 22.5° (see picture on page 9/5).
- Rounded and roller plungers according to EN 50041 with 3 mm overtravel (total travel 9 mm) for greater tolerance when switching.
- All enclosure sizes – now also including the small enclosure 31 mm wide – are optionally available with an LED signaling indicator (see picture on page 9/5).
- All enclosure variants have an integrated chlorinated rubber diaphragm (high functional safety in cold and aggressive environments).
- All contact blocks are replaceable (see page 9/48).
- The three-pole contact blocks are available for all enclosure sizes (see picture on page 9/5).
- Elements with 1 NO + 2 NC slow-action contacts with make-before-break and 2 NO + 1 NC
- The short-stroke contact block 1 NO + 1 NC improves the precision of the switching operation through a reduced actuation path.
- The switching element with 1 NO + 1 NC snap-action contacts with 2 x 2 mm contact opening is suitable for simultaneous disconnection and signaling, particularly in the elevator industry
- **NEW:** XL enclosures for accommodating two 2- or 3-pole contact blocks
- The molded-plastic enclosure with a width of 31 mm has simple and fast wiring equipment which makes it possible to save from approx. 20 to 25 % of the time when connecting (see picture on page 9/5).
- The ASIsafe electric component is integrated for the versions with the AS-Interface connection (see page 9/82); an additional adapter is not required.

Application

With the standard position switches, mechanical positions of moved machine parts are converted into electrical signals. Through their modular and uniform design and large number of variants, the devices can meet practically all requirements in industry.

Devices are available with enclosure versions to suit the particular ambient conditions. Different control tasks can be performed with the best contact blocks suited for the particular purpose. And many different actuator variants are available to match the mechanical configuration of the moved machined parts. Dimensions, fixing points and characteristics are largely in accordance with the EN 50041 or EN 50047 standards.

The devices are suitable for use in any climate.

Standards

IEC 60947-5-1 or EN 60947-5-1.



The protective measure of "total insulation" by the molded-plastic enclosure is guaranteed by the use of molded-plastic screw-glands.

Safety position switches

For controls according to IEC 60204-1 or EN 60204-1 the devices can be used as a safety position switch. To secure position switches against changes in their position, keyed techniques must be employed on installation.

Safety circuits

IEC 60947-5-1 and EN 60947-5-1 require positive opening of the NC contacts, i.e. for the purposes of personal safety, the assured opening of NC contacts is expressly stipulated for the electrical equipment of machines in all safety circuits and marked according to the IEC standard 60947-5-1 with the symbol .

Category 2 according to ISO 13849-1 (EN 954-1) can be attained with 3SE5 position switches with , and category 3 or 4 when using an additional position switch, if the corresponding failsafe evaluation units are selected and correctly installed, e.g. the 3TK28 safety relays or matching devices from the ASIsafe, SIMATIC or SINUMERIK product ranges. The operating mechanisms (actuators) must also be connected to the enclosure by keyed techniques. The corresponding operating mechanisms are marked in the catalog with .

Contacts for each application

- **Snap-action contacts:** NC and NO contacts switch simultaneously – regardless of the actuating speed ($v_{\min} = 0.01$ m/s) and contact erosion.
- **Slow-action contacts:** Difference in travel between "NC contact opens" and "NO contact closes"; the switching speed is the same as or proportional to the actuating speed ($v_{\min} = 0.4$ m/s).
- **Slow-action contacts with make-before-break:** e.g. suitable for adding a second function to a sequence control.

Operating mechanisms for each application

Standard, rounded and roller plungers

- Operation in direction of the plunger axis or in case of roller plunger with bar at right angles to the plunger axis
- The roller plunger is recommended for lateral actuation and relatively long overtravel.

Roller and angular roller levers

- For actuators made of finely ground steel in the form of cams, straight-edges (approach angle 30°) or cam disks

Spring rod

- Can be used for undefined actuations and changing starting conditions
- Starting from any direction is possible.



Twist levers and rod actuators

- For a high starting speed ($v = 1.5$ m/s)
- Variety of starting options
- Insensitive to oil, grinding dust and coarse-grained material
- Adjustment of the lever in increments of 10°.
- Can be adjusted with left or right switching

Fork lever

- Switchable in two directions
- Latching actuator
- For reciprocating movements

Technical specifications

Type		3SE5 1..., 3SE5 2..	3SE5 41.	3SE5 42.
General data				
Standards		IEC 60947-5-1, EN 60947-5-1		
Rated insulation voltage U_i	V	400	400	
Pollution degree acc. to EN 60664-1		Class 3	Class 3	
Rated impulse withstand voltage U_{imp}	kV	6	4	
Rated operational voltage U_e	V	400 V AC, over 300 V AC only for equal potential ¹⁾	300 AC	
Conventional thermal current I_{th}	A	10	6	10
Rated operational current I_e		2-pole	3-pole	2-pole
• With alternating current 50/60 Hz		$I_e/AC-15$	$I_e/AC-15$	$I_e/AC-15$
- At 24 V	A	6	6	6
- At 120 V	A	6	3	6
- At 240 V	A	3	1.5	3
• For direct current		$I_e/DC-13$	$I_e/DC-13$	$I_e/DC-13$
- At 24 V	A	3	3	3
- At 125 V	A	0.55	0.55	0.55
- At 250 V	A	0.27	0.27	0.27
Short-circuit protection²⁾				
• With DIAZED fuse links, operational class gG	A	6		
• With miniature circuit breaker, Char. C	A	1	2	1
Mechanical endurance				
• Basic switches		15 × 10 ⁶ operating cycles	30 × 10 ⁶ operating cycles	30 × 10 ⁶ operating cycles
• With spring rod, 3SE5 ...-R..		10 × 10 ⁶ operating cycles	--	--
• With fork lever, 3SE5 1...-T..		1 × 10 ⁶ operating cycles	--	--
Electrical endurance				
• With 3RH.1, 3RT contactors in size S00, S0		10 × 10 ⁶ operating cycles	10 × 10 ⁶ operating cycles	5 × 10 ⁶ operating cycles
• For utilization category AC-15 when switching off $I_e/AC-15$ at 240 V		0.1 × 10 ⁶ operating cycles	--	--
• With utilization category DC-12/DC-13		For direct current depending on the loading of the switch		
Switching frequency With 3RH.1, 3RT contactors in size S00, S0		6000 operating cycles/h	1800 operating cycles/h	
Switching accuracy For repeated switching, measured at the plunger of the contact block	mm	0.05		
• With twist actuators		1°		
Rated data according to ,  and 				
• Rated voltage	V	300		
• Uninterrupted current	A	6		
• Switching capacity		Heavy duty, A 300/ B 300 /Q 300	A 300 / Q 300	

¹⁾ For slow-action contacts 1 NO + 2 NC with make-before-break and
2 NO + 1 NC the following applies: over 250 V AC only equal potential.

²⁾ Without any welds according to EN 60947-5-1.

Type		3SE5 23.	3SE5 13	3SE5 24.	3SE5 21.	3SE5 11.	3SE5 12., 3SE5 16.	3SE5 4..	3SE5 25.
Enclosures									
Enclosures		Ultradim A3X2G7			Zinc diecasting GD Zn Al4 Cu1				--
• Material									
• Width	mm	31	40	50	31	40	56	30 / 40	30
Degree of protection acc. to EN 60529		IP65	IP66/IP67 ¹⁾					IP67	IP20, IP10
Ambient temperature									
• During operation	°C	-25 ... +85						-25 ... +85	-25 ... +85
• In operation, switch with LEDs	°C	-25 ... +70						--	--
• Storage, transport	°C	-40 ... +90						-40 ... +90	-40 ... +90
Mounting position		Any							
Connection									
Cable entry		1 × (M20 × 1.5)		2 × (M20 × 1.5)	1 × (M20 × 1.5)		3 × (M20 × 1.5)	--	--
Conductor cross-sections²⁾									
• Solid	mm ²	2 × (0.5 ... 0.75), 1 × (0.5 ... 1.5)							
• Finely stranded with end sleeve	mm ²	2 × (0.5 ... 1.5)							
Tightening torque , contact block	Nm	0.8 ... 1.0							
Protective conductor connection inside enclosure		--			M3.5			--	--

¹⁾ For twist actuators with spring rod and rod actuators: IP65/IP67.

²⁾ For the maximum number of connectable conductors for the respective contact block see operating instructions.

3SE5, 3SE2 Position Switches

General data

Dimensions of the basic switches

Enclosure width 31 mm, EN 50047, with M20 x 1.5 connecting thread 3SE5 232, 3SE5 212

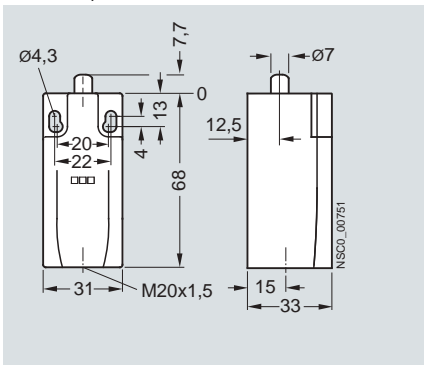

Enclosure width 31 mm, EN 50047, rear with fixing holes 3SE5 232, 3SE5 212

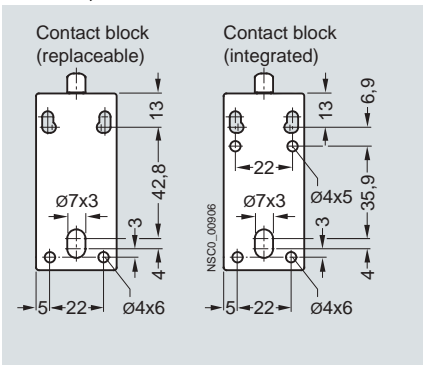

Enclosure width 31 mm, EN 50047, with M12 connector socket 3SE5 234, 3SE5 212

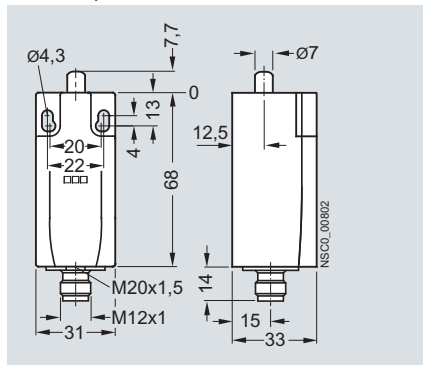

Enclosure width 50 mm, with M20 x 1.5 connecting thread 3SE5 242

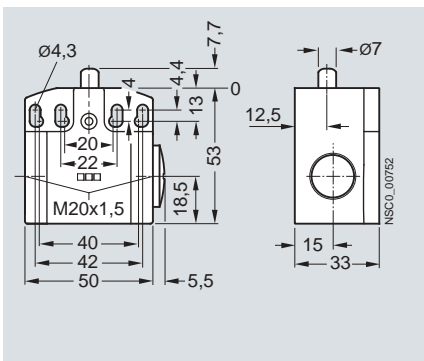

Enclosure width 50 mm, rear with fixing holes 3SE5 242

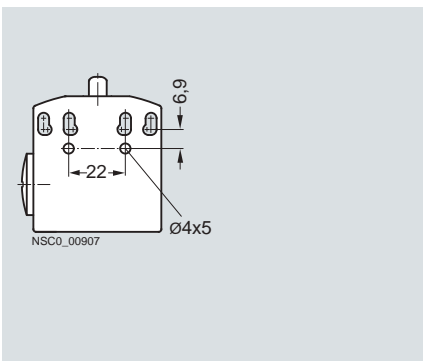

Enclosure width 40 mm, EN 50041, with M20 x 1.5 connecting thread 3SE5 112, 3SE5 132

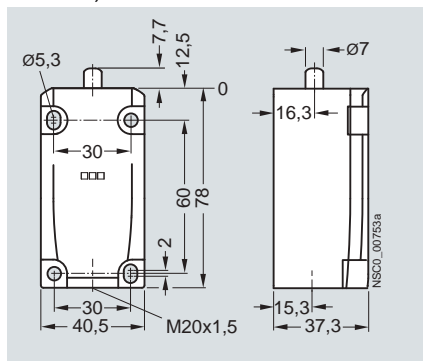

Enclosure width 40 mm, EN 50041, with 6-pole connector socket 3SE5 115

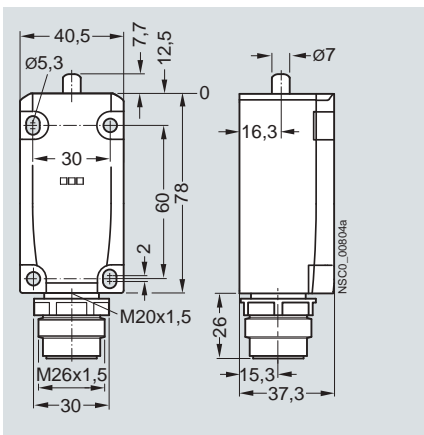

Enclosure width 56 mm, with M20 x 1.5 connecting thread 3SE5 122

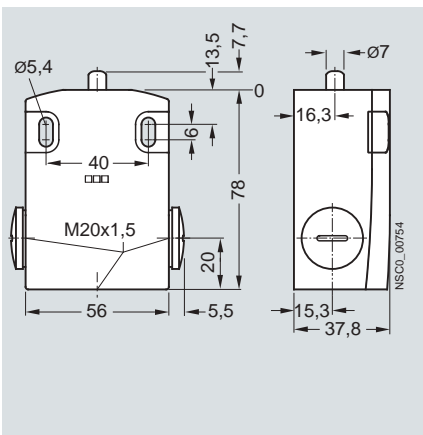

XL enclosure, width 56 mm, with M20 x 1.5 connecting thread 3SE5 162

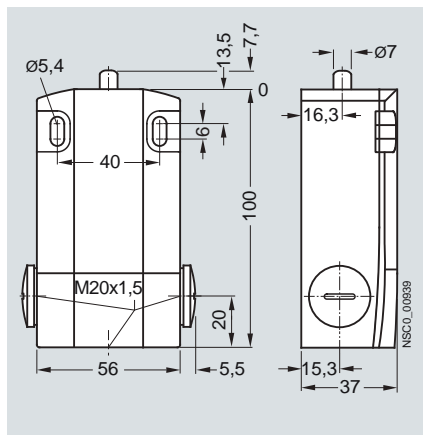

For operating mechanisms for basic switches, see pages 9/9 and 9/10.

Operating mechanisms for enclosure width 31 mm and 50 mm

Roller plunger, type C acc. to EN 50047

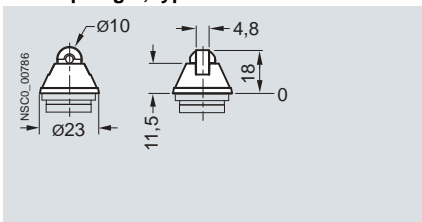

Roller plunger with central fixing

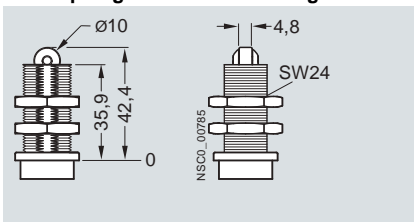

Roller lever, type E according to EN 50047

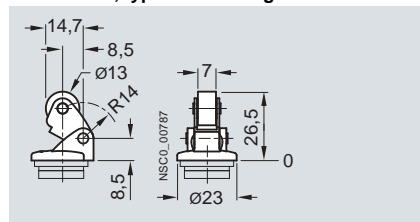

Angular roller lever

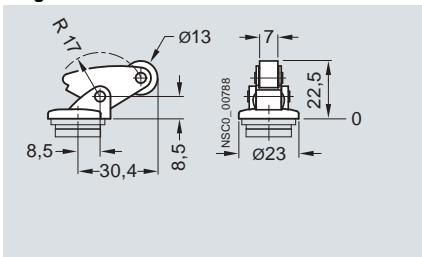

Twist lever, type A acc. to EN 50047

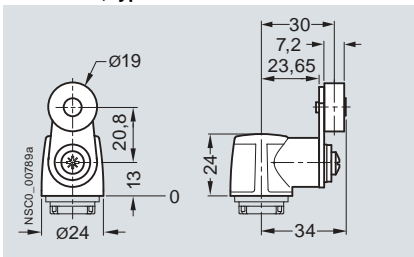

Twist lever, roller 30 mm

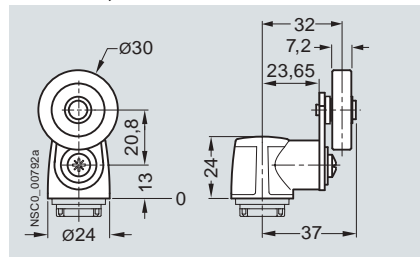

Operating mechanism for enclosure width 40 mm and 56 mm

Plain plunger

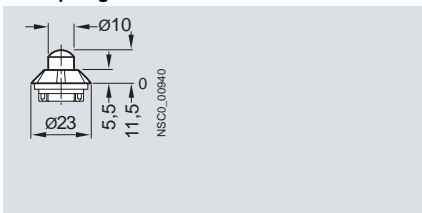

Rounded plunger, type B acc. to EN 50041

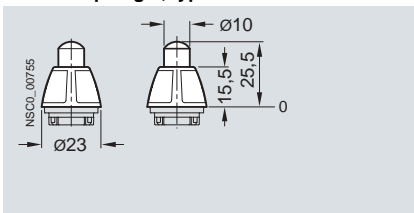

Roller plunger, type C acc. to EN 50041

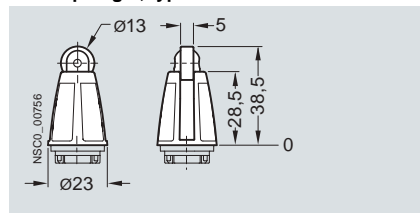

Roller lever

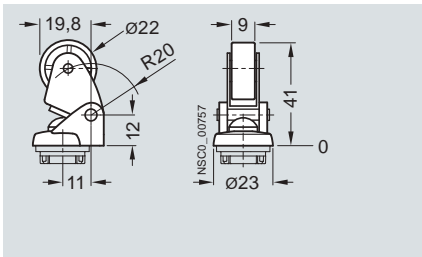

Angular roller lever

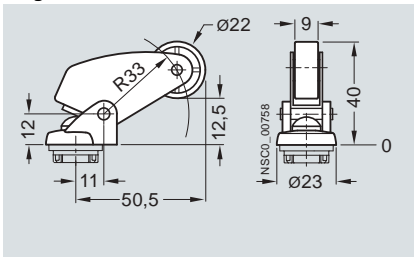

Twist lever, type A acc. to EN 50041

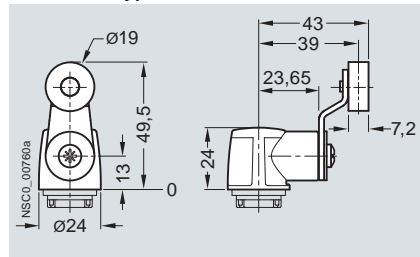

Twist lever, 2 rollers 19 mm

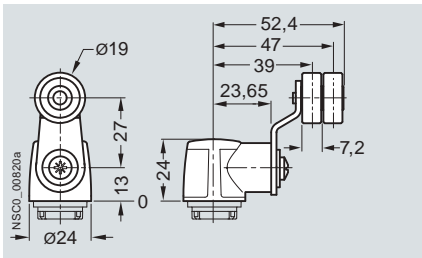

Fork lever, roller 19 mm

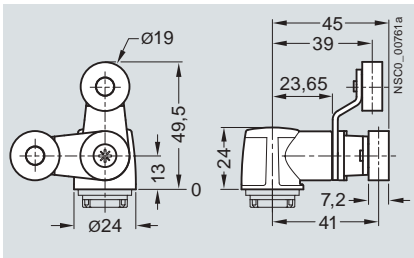

Twist lever, roller 30 mm

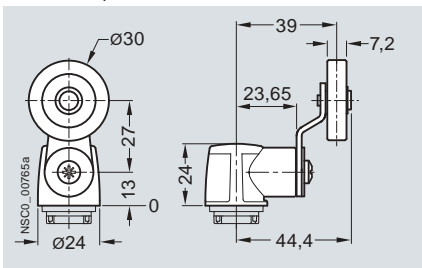

Twist lever, roller 50 mm

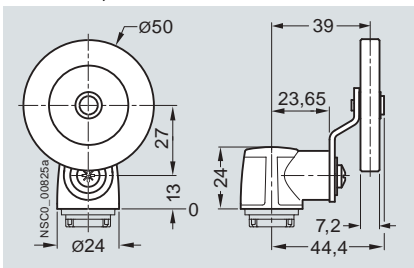

Twist lever, rubber roller 50 mm

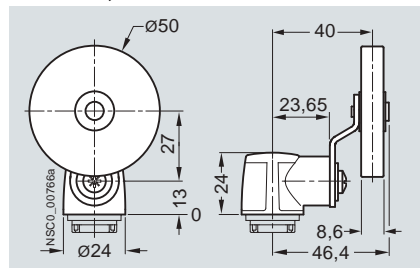

3SE5, 3SE2 Position Switches

General data

Operating mechanisms for all enclosure widths

Twist lever, adjustable length, roller 19 mm

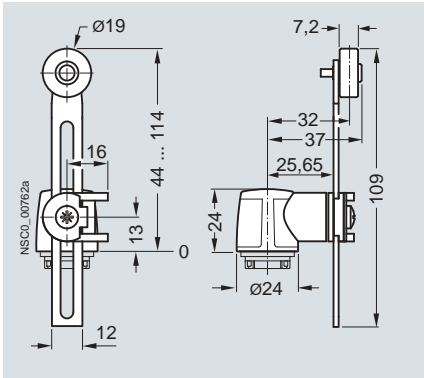

Twist lever, adjustable length, with grid hole, roller 19 mm

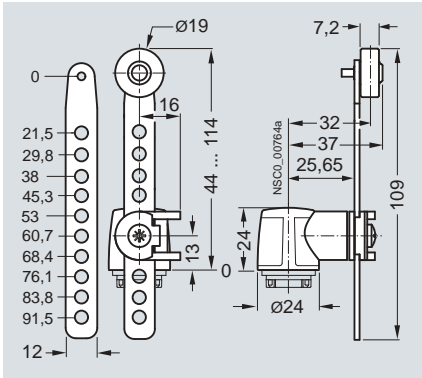

Twist lever, adjustable length, roller 30 mm

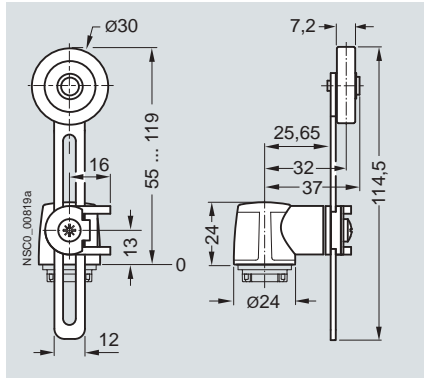

Twist lever, adjustable length, roller 50 mm

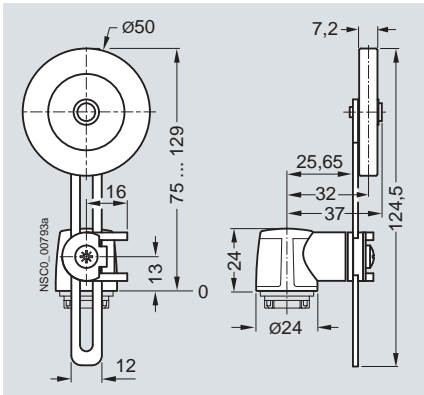

Twist lever, adjustable length, rubber roller 50 mm

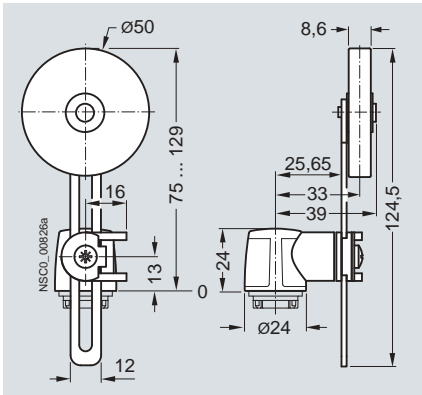

Twist lever, adjustable length, with grid hole, rubber roller 50 mm

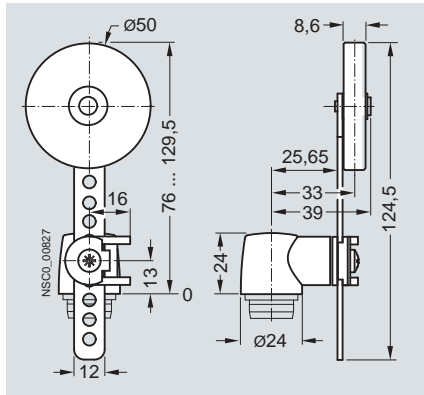

Rod actuator

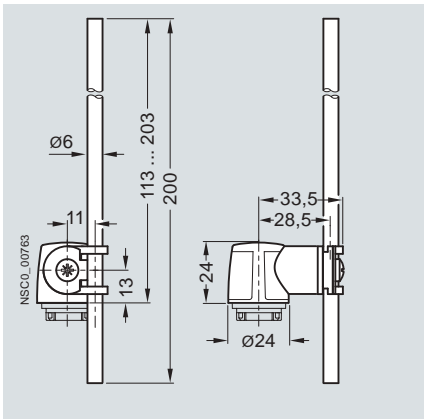

Spring rod, length 142.5 mm

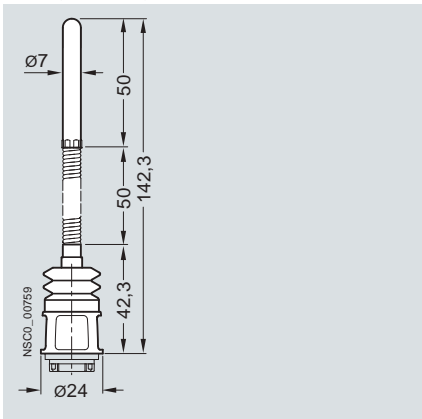

Spring rod, length 242.5 mm

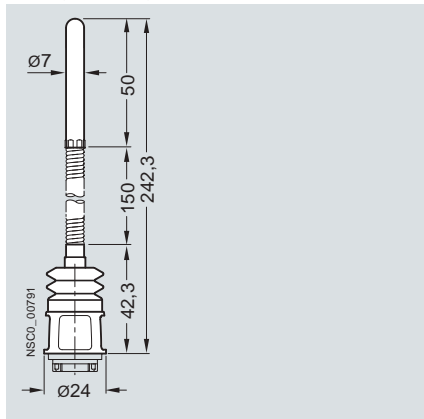

Spring rod, length 76 mm

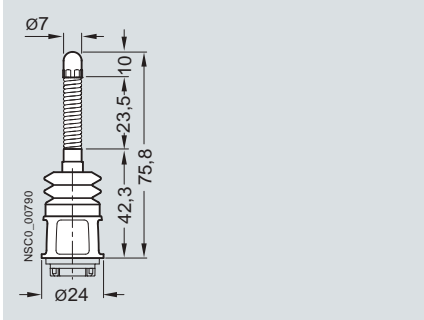

9

Circuit diagrams

Enclosure widths 31, 40, 50 and 56 mm

Slow-action contacts
1 NO + 1 NC
3SE5 ...-B..., -R...

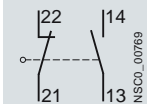

Slow-action contacts
2 NO + 1 NC
3SE5 ...-P...

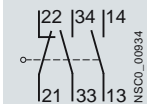

Snap-action contacts
1 NO + 1 NC
3SE5 ...-C..., -F..., -G..., -H..., -N...

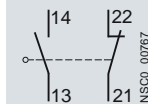

Slow-action contacts
1 NO + 2 NC
3SE5 ...-K..., -Q...

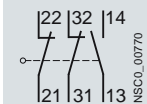

Slow-action contacts
1 NO + 2 NC with make-before-break, 3SE5 ...-M...

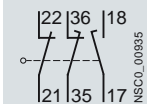

Snap-action contacts
1 NO + 2 NC
3SE5 ...-L...

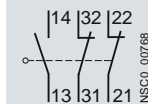

XL enclosures, width 56 mm

Slow-action contacts
2 x (1 NO + 1 NC)
3SE5 162-0B...



Slow-action contacts
2 x (1 NO + 2 NC) with make-before-break, 3SE5 162-0D...

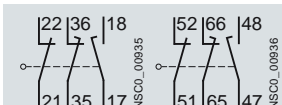

For slow-action contacts
1 NO + 2 NC with make-before-break, 1 NO + 1 NC
3SE5 162-0E...

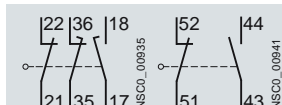

Snap-action contacts
2 x (1 NO + 1 NC)
3SE5 162-0C...



3SE5 connector assignment

M12 connector socket, 4-pole
3SY3 127



M12 connector socket, 5-pole
3SY3 128

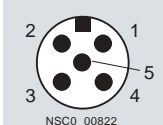

M12 connector socket, 8-pole
3SY3 134

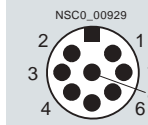

Connector socket, 6-pole + PE
3SY3 131

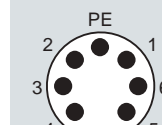

Order No.	Connector sockets		LEDs	Connections									
	Type	Version		Pin 1	Pin 2	Pin 3	Pin 4	Pin 5	Pin 6	Pin 7	Pin 8	PE	
M12 connector sockets (4-, 5- or 8-pole)													
3SE5..4-.....1AC4	3SY3 127	1 NO + 1 NC	--	21	22	13	14	--	--	--	--	--	
3SE5..4-.....1AC5	3SY3 128	1 NO + 1 NC	--	21	22	13	14	PE	--	--	--	--	
3SE5..4-.....1AE0	3SY3 127	2 NC	--	21	22	31	32	--	--	--	--	--	
3SE5..4-.....1AE1	3SY3 128	2 NC	--	21	22	31	32	PE	--	--	--	--	
3SE5..4-.....1AF3	3SY3 128	1 NO + 1 NC	2 LEDs	21	22	13 / LED gn	14 / LED ye	Ground LED	--	--	--	--	
3SE5..4-.....1AD4	3SY3 134	1 NO + 2 NC	2 LEDs	21	22	13 / LED gn	14 / LED ye	31	32	Ground LED	PE	--	
Connector sockets, 6-pole + PE													
3SE5..5-.....1AD0	3SY3 131	1 NO + 1 NC	--	21	22	13	14	--	--	--	--	✓	
3SE5..5-.....1AD1	3SY3 131	1 NO + 2 NC	--	21	22	13	14	31	32	--	--	✓	
3SE5..5-.....1AD2	3SY3 131	1 NO + 2 NC	2 LEDs	21	22	31	32	13 / LED gn	Ground LED	--	--	✓	
3SE5..5-.....1AF2	3SY3 131	1 NO + 1 NC	2 LEDs	21	22	13 / LED gn	14 / LED yw	--	Ground LED	--	--	✓	

gn Green
ye Yellow
✓ Connected

3SE5, 3SE2 Position Switches

General data

Options

On the following pages you will find selection tables for complete units as well as components of the modular system.

Complete units

Modular system

The differences between the units are indicated in the selection and ordering data by the symbols shown on orange backgrounds.

Using the modular system you can assemble switch variants which are not available as complete units. Each complete unit can also be supplied as a module.

A basic switch for the modular system comprises an enclosure with a contact block and a cover. Among the basic switches the following versions, for example, can be selected:

- Basic enclosure with teflon plunger
- Version with increased corrosion protection

- Version with 2 LEDs
- Version with M12 connector socket or 6-pole + PE
- Version with M12 connector socket and with 2 LEDs

For the molded-plastic enclosures with a width of 31 and 50 mm the basic switches are designed as complete units with rounded plunger (according to standard).

Online configurator

The online configurator helps you not only to select and order the right switch but also to create complete product documentation.

- Product data sheets
- Dimensional drawings
- Operating travel diagrams
- CAD data in 2D and 3D model images
- Ordering data
- Product photos

www.siemens.com/industrial-controls/configurators

Complete units

Ordering example

Required:

- Position switch according to EN 50047 in a molded-plastic enclosure
- Contact block with slow-action contacts 1 NO + 1 NC
- Angular roller lever, metal lever and plastic roller

To be ordered:

Version	Complete units	<input type="checkbox"/>
Order No.		
Complete units • Enclosure width 31 mm		
	Angular roller levers With metal lever and plastic roller 13 mm Slow-action contacts 1 NO + 1 NC	3SE5 232-0BF10

Modular system

Ordering example 1

Required:



- Position switch according to EN 50047 in a molded-plastic enclosure
- Contact block with slow-action contacts 1 NO + 1 NC
- Angular roller lever, metal lever and plastic roller

Ordering example 2



Required:

- Position switch according to EN 50047 in a molded-plastic enclosure
- Contact block with slow-action contacts 1 NO + 1 NC
- Twist lever, high-grade steel lever and plastic roller

To be ordered separately:

Version	Modular system	<input checked="" type="checkbox"/>
Order No.		
Basic switches • Enclosure width 31 mm		
	With teflon plunger Slow-action contacts 1 NO + 1 NC	3SE5 232-0BC05
+		
Operating mechanisms		
	Angular roller levers Metal lever, plastic roller	3SE5 000-0AF10

To be ordered separately:







Version	Modular system	<input checked="" type="checkbox"/>
Order No.		
Basic switches • Enclosure width 31 mm		
	With teflon plunger Slow-action contacts 1 NO + 1 NC	3SE5 232-0BC05
+		
Twist actuators		
	Twist actuators	3SE5 000-0AK00
	Twist levers High-grade steel lever, plastic roller	3SE5 000-0AA31

3SE5, molded-plastic enclosures
Enclosure width 31 mm according to EN 50047

Selection and ordering data

Complete units

2 or 3 contacts · Degree of protection IP65 · Cable entry M20 × 1.5¹⁾

Version	Contacts	LEDs	DT	Complete units	Price per PU	PU (UNIT, SET, M)	PS*	PG
				Order No.				
Complete units²⁾ • Enclosure width 31 mm								
Rounded plungers, type B, acc. to EN 50047								
 Rounded plunger	With teflon plunger							
	Slow-action contacts	1 NO + 1 NC --	⊕ ▶	3SE5 232-0BC05		1	1 unit	102
	Snap-action contacts	1 NO + 1 NC --	⊕ B	3SE5 232-0CC05		1	1 unit	102
	Snap-action contacts, integrated ³⁾	1 NO + 1 NC --	⊕ ▶	3SE5 232-0HC05		1	1 unit	102
	Snap-action contacts • Short-stroke, integrated ³⁾	1 NO + 1 NC --	⊕ B	3SE5 232-0FC05		1	1 unit	102
	Snap-action contacts • 2 × 2 mm contact gap	1 NO + 1 NC --	⊕ B	3SE5 232-0GC05		1	1 unit	102
	Slow-action contacts	1 NO + 2 NC --	⊕ A	3SE5 232-0KC05		1	1 unit	102
	Snap-action contacts	1 NO + 2 NC --	⊕ A	3SE5 232-0LC05		1	1 unit	102
	Slow-action contacts with make-before-break	1 NO + 2 NC --	⊕ A	3SE5 232-0MC05		1	1 unit	102
	Slow-action contacts	2 NO + 1 NC --	⊕ A	3SE5 232-0PC05		1	1 unit	102
 With increased corrosion protection	With increased corrosion protection							
	Slow-action contacts	1 NO + 1 NC --	⊕ B	3SE5 232-0BC05-1CA0		1	1 unit	102
	Snap-action contacts	1 NO + 1 NC --	⊕ B	3SE5 232-0CC05-1CA0		1	1 unit	102
	Slow-action contacts	1 NO + 2 NC --	⊕ B	3SE5 232-0KC05-1CA0		1	1 unit	102
	Snap-action contacts	1 NO + 2 NC --	⊕ B	3SE5 232-0LC05-1CA0		1	1 unit	102
	Slow-action contacts with make-before-break	1 NO + 2 NC --	⊕ B	3SE5 232-0MC05-1CA0		1	1 unit	102
 With 2 LEDs	With M12 connector socket, 4-pole (250 V, 4 A)							
	Slow-action contacts	1 NO + 1 NC --	⊕ B	3SE5 234-0BC05-1AC4		1	1 unit	102
	Snap-action contacts, integrated ³⁾	1 NO + 1 NC --	⊕ A	3SE5 234-0HC05-1AC4		1	1 unit	102
	Slow-action contacts	2 NC --	⊕ B	3SE5 234-0KC05-1AE0		1	1 unit	102
 With 2 LEDs	With 2 LEDs, yellow/green							
	Slow-action contacts	1 NO + 2 NC 24 V DC	⊕ B	3SE5 232-1KC05		1	1 unit	102
	Snap-action contacts	1 NO + 2 NC 24 V DC	⊕ B	3SE5 232-1LC05		1	1 unit	102
	Slow-action contacts	1 NO + 2 NC 230 V AC	⊕ B	3SE5 232-3KC05		1	1 unit	102
	Snap-action contacts	1 NO + 2 NC 230 V AC	⊕ B	3SE5 232-3LC05		1	1 unit	102
 With M12 connector socket, 5-pole (125 V, 4 A) and 2 LEDs	With M12 connector socket, 5-pole (125 V, 4 A) and 2 LEDs							
	Slow-action contacts	1 NO + 1 NC 24 V DC	⊕ B	3SE5 234-1BC05-1AF3		1	1 unit	102
 Roller plunger	Roller plungers, type C acc. to EN 50047							
	With plastic roller 10 mm							
	Slow-action contacts	1 NO + 1 NC --	⊕ B	3SE5 232-0BD03		1	1 unit	102
	Snap-action contacts • Integrated ³⁾	1 NO + 1 NC --	⊕ ▶	3SE5 232-0HD03		1	1 unit	102
	Snap-action contacts • Short-stroke, integrated ³⁾	1 NO + 1 NC --	⊕ B	3SE5 232-0FD03		1	1 unit	102
	Slow-action contacts	1 NO + 2 NC --	⊕ B	3SE5 232-0KD03		1	1 unit	102
	Snap-action contacts	1 NO + 2 NC --	⊕ B	3SE5 232-0LD03		1	1 unit	102
	Actuator head rotated by 90°							
	Snap-action contacts	1 NO + 2 NC --	⊕ B	3SE5 232-0LD03-1AH0		1	1 unit	102
	With M12 connector socket, 4-pole (250 V, 4 A)							
Snap-action contacts, integrated ³⁾	1 NO + 1 NC --	⊕ B	3SE5 234-0HD03-1AC4		1	1 unit	102	
 Roller plunger with central fixing	Roller plungers with central fixing							
	Snap-action contacts, integrated ³⁾	1 NO + 1 NC --	⊕ B	3SE5 232-0HD10		1	1 unit	102
	Slow-action contacts	1 NO + 2 NC --	⊕ B	3SE5 232-0KD10		1	1 unit	102

⊕ Positive opening according to IEC 60947-5-1, Appendix K.

¹⁾ A cable gland with seal must be used with the quick-connect method.

²⁾ Popular versions.







³⁾ Subsequent replacement of contact blocks is not possible.

* You can order this quantity or a multiple thereof.
Illustrations are approximate

3SE5, 3SE2 Position Switches

3SE5, molded-plastic enclosures Enclosure width 31 mm according to EN 50047

2 or 3 contacts · Degree of protection IP65 · Cable entry M20 × 1.5¹⁾

Version	Contacts	LEDs	DT	Complete units	<input type="checkbox"/>	PU (UNIT, SET, M)	PS*	PG
				Order No.	Price per PU			
Complete units²⁾ • Enclosure width 31 mm								
Roller levers, type E acc. to EN 50047								
With metal lever and plastic roller 13 mm								
	Slow-action contacts	1 NO + 1 NC --	⊕ A	3SE5 232-0BE10		1	1 unit	102
	Snap-action contacts, integrated ³⁾	1 NO + 1 NC --	⊕ ▶	3SE5 232-0HE10		1	1 unit	102
	Slow-action contacts	1 NO + 2 NC --	⊕ B	3SE5 232-0KE10		1	1 unit	102
	Snap-action contacts	1 NO + 2 NC --	⊕ B	3SE5 232-0LE10		1	1 unit	102
	With M12 connector socket, 4-pole (250 V, 4 A)							
	Snap-action contacts, integrated ³⁾	1 NO + 1 NC --	⊕ B	3SE5 234-0HE10-1AC4		1	1 unit	102
Angular roller levers								
With metal lever and plastic roller 13 mm								
	Slow-action contacts	1 NO + 1 NC --	⊕ B	3SE5 232-0BF10		1	1 unit	102
	Snap-action contacts, integrated ³⁾	1 NO + 1 NC --	⊕ A	3SE5 232-0HF10		1	1 unit	102
	Slow-action contacts	1 NO + 2 NC --	⊕ B	3SE5 232-0KF10		1	1 unit	102
	Snap-action contacts	1 NO + 2 NC --	⊕ B	3SE5 232-0LF10		1	1 unit	102
Spring rods								
Length 142.5 mm, with plastic plunger 50 mm								
	Snap-action contacts, integrated ³⁾	1 NO + 1 NC --	A	3SE5 232-0HR01		1	1 unit	102
	With M12 connector socket, 4-pole (250 V, 4 A)							
	Snap-action contacts, integrated ³⁾	1 NO + 1 NC --	B	3SE5 234-0HR01-1AC4		1	1 unit	102
Twist levers, type A acc. to EN 50047								
With metal lever 21 mm and plastic roller 19 mm								
	Slow-action contacts	1 NO + 1 NC --	⊕ A	3SE5 232-0BK21		1	1 unit	102
	Snap-action contacts, integrated ³⁾	1 NO + 1 NC --	⊕ B	3SE5 232-0HK21		1	1 unit	102
	Slow-action contacts	1 NO + 2 NC --	⊕ B	3SE5 232-0KK21		1	1 unit	102
	Snap-action contacts	1 NO + 2 NC --	⊕ B	3SE5 232-0LK21		1	1 unit	102
	With M12 connector socket, 4-pole (250 V, 4 A)							
	Snap-action contacts, integrated ³⁾	1 NO + 1 NC --	⊕ B	3SE5 234-0HK21-1AC4		1	1 unit	102
	With metal lever 35 mm and plastic roller 19 mm							
	Snap-action contacts, integrated ³⁾	1 NO + 1 NC --	⊕ B	3SE5 232-0HK15		1	1 unit	102
Twist levers, adjustable length								
With metal lever with grid hole and plastic roller 19 mm								
	Snap-action contacts, integrated ³⁾	1 NO + 1 NC --	⊕ A	3SE5 232-0HK60		1	1 unit	102
	With metal lever and plastic roller 19 mm							
	Slow-action contacts	1 NO + 1 NC --	B	3SE5 232-0BK50		1	1 unit	102
	Snap-action contacts, integrated ³⁾	1 NO + 1 NC --	▶	3SE5 232-0HK50		1	1 unit	102
	Snap-action contacts	1 NO + 2 NC --	B	3SE5 232-0LK50		1	1 unit	102
	With M12 connector socket, 4-pole (250 V, 4 A)							
	Snap-action contacts, integrated ³⁾	1 NO + 1 NC --	B	3SE5 234-0HK50-1AC4		1	1 unit	102
Rod actuators								
With aluminum rod, length 200 mm								
	Snap-action contacts, integrated ³⁾	1 NO + 1 NC --	B	3SE5 232-0HK80		1	1 unit	102
	With plastic rod, length 200 mm							
	Snap-action contacts, integrated ³⁾	1 NO + 1 NC --	B	3SE5 232-0HK82		1	1 unit	102
	With M12 connector socket, 4-pole (250 V, 4 A)							
	Snap-action contacts, integrated ³⁾	1 NO + 1 NC --	B	3SE5 234-0HK82-1AC4		1	1 unit	102

Note: If the device you require is not available as a complete unit, see "Modular system" on the next page.

⊕ Positive opening according to IEC 60947-5-1, Appendix K.

¹⁾ A cable gland with seal must be used with the quick-connect method.

²⁾ Popular versions.





³⁾ Subsequent replacement of contact blocks is not possible.

3SE5, 3SE2 Position Switches

3SE5, molded-plastic enclosures
Enclosure width 31 mm according to EN 50047

Modular system

2 or 3 contacts · Degree of protection IP65 · Cable entry M20 × 1.5¹⁾

Version	Contacts	LEDs	DT	Modular system	PU (UNIT, SET, M)	PS*	PG
				Order No.	Price per PU		
Basic switches • Enclosure width 31 mm (with rounded plunger²⁾)							
 Basic switch	With teflon plunger						
	Slow-action contacts	1 NO + 1 NC --	⊕ ▶	3SE5 232-0BC05	1	1 unit	102
	Snap-action contacts	1 NO + 1 NC --	⊕ B	3SE5 232-0CC05	1	1 unit	102
	Snap-action contacts, integrated ³⁾	1 NO + 1 NC --	⊕ ▶	3SE5 232-0HC05	1	1 unit	102
	Snap-action contacts • Short-stroke, integrated ³⁾	1 NO + 1 NC --	⊕ B	3SE5 232-0FC05	1	1 unit	102
	Snap-action contacts • 2 × 2 mm contact gap	1 NO + 1 NC --	⊕ B	3SE5 232-0GC05	1	1 unit	102
	Slow-action contacts	1 NO + 2 NC --	⊕ A	3SE5 232-0KC05	1	1 unit	102
	Snap-action contacts	1 NO + 2 NC --	⊕ A	3SE5 232-0LC05	1	1 unit	102
	Slow-action contacts with make-before-break	1 NO + 2 NC --	⊕ A	3SE5 232-0MC05	1	1 unit	102
Slow-action contacts	2 NO + 1 NC --	⊕ A	3SE5 232-0PC05	1	1 unit	102	
 With increased corrosion protection	With increased corrosion protection⁴⁾						
	Slow-action contacts	1 NO + 1 NC --	⊕ B	3SE5 232-0BC05-1CA0	1	1 unit	102
	Snap-action contacts	1 NO + 1 NC --	⊕ B	3SE5 232-0CC05-1CA0	1	1 unit	102
	Slow-action contacts	1 NO + 2 NC --	⊕ B	3SE5 232-0KC05-1CA0	1	1 unit	102
	Snap-action contacts	1 NO + 2 NC --	⊕ B	3SE5 232-0LC05-1CA0	1	1 unit	102
	Slow-action contacts with make-before-break	1 NO + 2 NC --	⊕ B	3SE5 232-0MC05-1CA0	1	1 unit	102
 With M12 socket	With M12 connector socket, 4-pole (250 V, 4 A)						
	Slow-action contacts	1 NO + 1 NC --	⊕ B	3SE5 234-0BC05-1AC4	1	1 unit	102
	Snap-action contacts, integrated ³⁾	1 NO + 1 NC --	⊕ A	3SE5 234-0HC05-1AC4	1	1 unit	102
	Slow-action contacts	2 NC --	⊕ B	3SE5 234-0KC05-1AE0	1	1 unit	102
Snap-action contacts	2 NC --	⊕ A	3SE5 234-0LC05-1AE0	1	1 unit	102	
 With 2 LEDs	With 2 LEDs, yellow/green						
	Slow-action contacts	1 NO + 2 NC 24 V DC	⊕ B	3SE5 232-1KC05	1	1 unit	102
	Snap-action contacts	1 NO + 2 NC 24 V DC	⊕ B	3SE5 232-1LC05	1	1 unit	102
	Slow-action contacts	1 NO + 2 NC 230 V AC	⊕ B	3SE5 232-3KC05	1	1 unit	102
Snap-action contacts	1 NO + 2 NC 230 V AC	⊕ B	3SE5 232-3LC05	1	1 unit	102	
 With M12 socket and 2 LEDs	With M12 connector socket, 5-pole (125 V, 4 A) and 2 LEDs						
	Slow-action contacts	1 NO + 1 NC 24 V DC	⊕ B	3SE5 234-1BC05-1AF3	1	1 unit	102
Snap-action contacts	1 NO + 1 NC 24 V DC	⊕ B	3SE5 234-1CC05-1AF3	1	1 unit	102	

⊕ Positive opening according to IEC 60947-5-1, Appendix K, or positively driven actuator, necessary in safety circuits.

¹⁾ A cable gland with seal must be used with the quick-connect method.

²⁾ On the plastic version the basic switch is a complete unit with rounded plunger.











³⁾ Subsequent replacement of contact blocks is not possible.

⁴⁾ Use corresponding high-grade steel lever.

Note: For selection aid, see page 9/12.

3SE5, 3SE2 Position Switches

3SE5, molded-plastic enclosures Enclosure width 31 mm according to EN 50047

Version	Diameter	DT	Modular system	PU (UNIT, SET, M)	PS*	PG
	mm		Order No.	Price per PU		
Operating mechanisms						
 Roller plunger	Roller plungers, type C acc. to EN 50047					
	Plastic rollers	10	⊕ A	3SE5 000-0AD03	1	1 unit 102
	High-grade steel rollers	10	⊕ B	3SE5 000-0AD04	1	1 unit 102
 With central fixing	Roller plungers with central fixing					
	Plastic rollers	10	⊕ B	3SE5 000-0AD10	1	1 unit 102
	High-grade steel rollers	10	⊕ B	3SE5 000-0AD11	1	1 unit 102
 Roller lever	Roller levers, type E acc. to EN 50047					
	Metal lever, plastic roller	13	⊕ A	3SE5 000-0AE10	1	1 unit 102
	Metal lever, high-grade steel roller	13	⊕ B	3SE5 000-0AE11	1	1 unit 102
	High-grade steel lever, plastic roller	13	⊕ B	3SE5 000-0AE12	1	1 unit 102
	High-grade steel lever, high-grade steel roller	13	⊕ B	3SE5 000-0AE13	1	1 unit 102
 Angular roller lever	Angular roller levers					
	Metal lever, plastic roller	13	⊕ A	3SE5 000-0AF10	1	1 unit 102
	Metal lever, high-grade steel roller	13	⊕ B	3SE5 000-0AF11	1	1 unit 102
	High-grade steel lever, plastic roller	13	⊕ A	3SE5 000-0AF12	1	1 unit 102
	High-grade steel lever, high-grade steel roller	13	⊕ B	3SE5 000-0AF13	1	1 unit 102
 Spring rod	Spring rods (for switches with snap-action contacts only)					
	Plastic plunger:					
	• Length 142.5 mm (spring 50 mm, plunger 50 mm)		B	3SE5 000-0AR01	1	1 unit 102
	• Length 76 mm (spring 23.5 mm, plunger 10 mm)		B	3SE5 000-0AR03	1	1 unit 102
	• Length 242.5 mm (spring 150 mm, plunger 50 mm)		B	3SE5 000-0AR04	1	1 unit 102
High-grade steel plunger:						
• Length 142.5 mm (spring 50 mm, plunger 50 mm)		B	3SE5 000-0AR02	1	1 unit 102	
Twist actuators						
 Twist actuator	Twist actuators, plastic (without lever) Switching right and/or left, adjustable		⊕ A	3SE5 000-0AK00	1	1 unit 102
	Levers for twist actuators					
 Twist lever	Twist levers 21 mm, straight, type A acc. to EN 50047					
	Metal lever, plastic roller	19	⊕ A	3SE5 000-0AA21	1	1 unit 102
	Metal lever, high-grade steel roller	19	⊕ B	3SE5 000-0AA22	1	1 unit 102
	Metal lever, roller with ball bearing	19	⊕ B	3SE5 000-0AA23	1	1 unit 102
	Metal lever, plastic roller	30	⊕ B	3SE5 000-0AA25	1	1 unit 102
	High-grade steel lever, plastic roller	19	⊕ B	3SE5 000-0AA31	1	1 unit 102
	High-grade steel lever, high-grade steel roller	19	⊕ B	3SE5 000-0AA32	1	1 unit 102
 Twist lever, adjustable length	Twist levers 30 mm, straight¹⁾					
	Metal lever, plastic roller	19	⊕ B	3SE5 000-0AA24	1	1 unit 102
 Twist lever, adjustable length	Twist levers, adjustable length, with grid hole					
	Metal lever, plastic roller	19	⊕ B	3SE5 000-0AA60	1	1 unit 102
	Metal lever, high-grade steel roller	19	⊕ B	3SE5 000-0AA61	1	1 unit 102
	Metal lever, plastic roller	50	⊕ B	3SE5 000-0AA67	1	1 unit 102
	Metal lever, rubber roller	50	⊕ B	3SE5 000-0AA68	1	1 unit 102
	High-grade steel lever, plastic roller	19	⊕ B	3SE5 000-0AA62	1	1 unit 102
	High-grade steel lever, high-grade steel roller	19	⊕ B	3SE5 000-0AA63	1	1 unit 102
 Rod actuator	Twist levers, adjustable length					
	Metal lever, plastic roller	19	A	3SE5 000-0AA50	1	1 unit 102
	Metal lever, high-grade steel roller	19	B	3SE5 000-0AA51	1	1 unit 102
	Metal lever, plastic roller	30	B	3SE5 000-0AA55	1	1 unit 102
	Metal lever, plastic roller	50	B	3SE5 000-0AA57	1	1 unit 102
	Metal lever, rubber roller	50	B	3SE5 000-0AA58	1	1 unit 102
	High-grade steel lever, plastic roller	19	B	3SE5 000-0AA52	1	1 unit 102
	High-grade steel lever, high-grade steel roller	19	B	3SE5 000-0AA53	1	1 unit 102
Rod actuators						
Aluminum rod, length 200 mm	6	B	3SE5 000-0AA80	1	1 unit 102	
Spring rod, length 200 mm	6	B	3SE5 000-0AA81	1	1 unit 102	
Plastic rod, length 200 mm	6	B	3SE5 000-0AA82	1	1 unit 102	

⊕ Positively driven actuator, necessary in safety circuits.

¹⁾ Can be clinch mounted (turned through 180°, rear of lever).

3SE5, molded-plastic enclosures
Enclosure width 40 mm according to EN 50041

Selection and ordering data

Complete units

2 or 3 contacts · Degree of protection IP66/67 · Cable entry M20 × 1.5

Version	Contacts	LEDs	DT	Complete units	Price per PU	PU (UNIT, SET, M)	PS*	PG
				Order No.	Price per PU			
Complete units¹⁾ · Enclosure width 40 mm								
Plain plungers								
With high-grade steel plunger								
 Plain plunger	Slow-action contacts	1 NO + 1 NC --	⊕ A	3SE5 132-0BB01		1	1 unit	102
	Snap-action contacts	1 NO + 1 NC --	⊕ A	3SE5 132-0CB01		1	1 unit	102
	Slow-action contacts	1 NO + 2 NC --	⊕ B	3SE5 132-0KB01		1	1 unit	102
	Snap-action contacts	1 NO + 2 NC --	⊕ B	3SE5 132-0LB01		1	1 unit	102
	Slow-action contacts	2 NO + 1 NC --	⊕ B	3SE5 132-0PB01		1	1 unit	102
Rounded plungers, type B acc. to EN 50041								
With plastic plunger								
 Rounded plunger	Slow-action contacts	1 NO + 1 NC --	⊕ B	3SE5 132-0BC03		1	1 unit	102
	Snap-action contacts	1 NO + 1 NC --	⊕ A	3SE5 132-0CC03		1	1 unit	102
	Slow-action contacts	1 NO + 2 NC --	⊕ B	3SE5 132-0KC03		1	1 unit	102
	Snap-action contacts	1 NO + 2 NC --	⊕ A	3SE5 132-0LC03		1	1 unit	102
	Slow-action contacts	2 NO + 1 NC --	⊕ B	3SE5 132-0PC03		1	1 unit	102
Roller plungers, type C acc. to EN 50041								
With plastic roller 13 mm								
 Roller plunger	Slow-action contacts	1 NO + 1 NC --	⊕ B	3SE5 132-0BD05		1	1 unit	102
	Snap-action contacts	1 NO + 1 NC --	⊕ B	3SE5 132-0CD05		1	1 unit	102
	Slow-action contacts	1 NO + 2 NC --	⊕ B	3SE5 132-0KD05		1	1 unit	102
	Snap-action contacts	1 NO + 2 NC --	⊕ B	3SE5 132-0LD05		1	1 unit	102
	Slow-action contacts	2 NO + 1 NC --	⊕ B	3SE5 132-0PD05		1	1 unit	102
Roller levers								
With metal lever and plastic roller 22 mm								
 Roller lever	Slow-action contacts	1 NO + 1 NC --	⊕ B	3SE5 132-0BE05		1	1 unit	102
	Snap-action contacts	1 NO + 1 NC --	⊕ B	3SE5 132-0CE05		1	1 unit	102
	Slow-action contacts	1 NO + 2 NC --	⊕ B	3SE5 132-0KE05		1	1 unit	102
	Snap-action contacts	1 NO + 2 NC --	⊕ B	3SE5 132-0LE05		1	1 unit	102
	Slow-action contacts	2 NO + 1 NC --	⊕ B	3SE5 132-0PE05		1	1 unit	102
Angular roller levers								
With metal lever and plastic roller 22 mm								
 Angular roller lever	Slow-action contacts	1 NO + 1 NC --	⊕ B	3SE5 132-0BF05		1	1 unit	102
	Snap-action contacts	1 NO + 1 NC --	⊕ B	3SE5 132-0CF05		1	1 unit	102
	Snap-action contacts	1 NO + 2 NC --	⊕ B	3SE5 132-0LF05		1	1 unit	102
Spring rods								
Length 142.5 mm, with plastic plunger 50 mm								
 Spring rod	Snap-action contacts	1 NO + 1 NC --	A	3SE5 132-0CR01		1	1 unit	102
	Snap-action contacts	1 NO + 2 NC --	B	3SE5 132-0LR01		1	1 unit	102

⊕ Positive opening according to IEC 60947-5-1, Appendix K.





¹⁾ Popular versions.

* You can order this quantity or a multiple thereof.
Illustrations are approximate

3SE5, 3SE2 Position Switches

3SE5, molded-plastic enclosures Enclosure width 40 mm according to EN 50041

2 or 3 contacts · Degree of protection IP66/IP67 · Cable entry M20 × 1.5

Version	Contacts	LEDs	DT	Complete units	<input type="checkbox"/>	PU (UNIT, SET, M)	PS*	PG
				Order No.	Price per PU			
Complete units¹⁾ · Enclosure width 40 mm								
Twist levers, type A acc. to EN 50041								
With metal lever 27 mm and plastic roller 19 mm								
	Slow-action contacts	1 NO + 1 NC --	⊕ B	3SE5 132-0BJ01		1	1 unit	102
	Snap-action contacts	1 NO + 1 NC --	⊕ A	3SE5 132-0CJ01		1	1 unit	102
	Slow-action contacts	1 NO + 2 NC --	⊕ B	3SE5 132-0KJ01		1	1 unit	102
	Snap-action contacts	1 NO + 2 NC --	⊕ B	3SE5 132-0LJ01		1	1 unit	102
	Slow-action contacts	2 NO + 1 NC --	⊕ B	3SE5 132-0PJ01		1	1 unit	102
Twist levers, adjustable length								
With metal lever with grid hole and plastic roller 19 mm								
	Snap-action contacts	1 NO + 1 NC --	⊕ B	3SE5 132-0CJ60		1	1 unit	102
	Snap-action contacts	1 NO + 2 NC --	⊕ B	3SE5 132-0LJ60		1	1 unit	102
With metal lever and plastic roller 19 mm								
	Snap-action contacts	1 NO + 1 NC --	B	3SE5 132-0CJ50		1	1 unit	102
	Snap-action contacts	1 NO + 2 NC --	B	3SE5 132-0LJ50		1	1 unit	102
Rod actuators, type D, acc. to EN 50041								
With aluminum rod, length 200 mm								
	Snap-action contacts	1 NO + 1 NC --	A	3SE5 132-0CJ80		1	1 unit	102
	Snap-action contacts	1 NO + 1 NC --	B	3SE5 132-0CJ82		1	1 unit	102

⊕ Positive opening according to IEC 60947-5-1, Appendix K.

¹⁾ Popular versions.





Note: If the device you require is not available as a complete unit, see "Modular system" on the next page.

3SE5, 3SE2 Position Switches

3SE5, molded-plastic enclosures
Enclosure width 40 mm according to EN 50041

Modular system

2 or 3 contacts · Degree of protection IP66/IP67 · Cable entry M20 × 1.5

Version	Contacts	LEDs	DT	Modular system	PU (UNIT, SET, M)	PS*	PG
				Order No.	Price per PU		
Basic switches • Enclosure width 40 mm							
With M20 × 1.5 connecting thread							
 Basic switch	Slow-action contacts	1 NO + 1 NC --	⊕ A	3SE5 132-0BA00	1	1 unit	102
	Snap-action contacts	1 NO + 1 NC --	⊕ A	3SE5 132-0CA00	1	1 unit	102
	• Gold-plated contacts		⊕ B	3SE5 132-0CA00-1AC1	1	1 unit	102
	Slow-action contacts	1 NO + 2 NC --	⊕ A	3SE5 132-0KA00	1	1 unit	102
	Snap-action contacts	1 NO + 2 NC --	⊕ A	3SE5 132-0LA00	1	1 unit	102
	Slow-action contacts with make-before-break	1 NO + 2 NC --	⊕ A	3SE5 132-0MA00	1	1 unit	102
	Slow-action contacts	2 NO + 1 NC --	⊕ A	3SE5 132-0PA00	1	1 unit	102
With increased corrosion protection¹⁾							
 With increased corrosion protection	Slow-action contacts	1 NO + 1 NC --	⊕ B	3SE5 132-0BA00-1CA0	1	1 unit	102
	Snap-action contacts	1 NO + 1 NC --	⊕ B	3SE5 132-0CA00-1CA0	1	1 unit	102
	Slow-action contacts	1 NO + 2 NC --	⊕ B	3SE5 132-0KA00-1CA0	1	1 unit	102
	Snap-action contacts	1 NO + 2 NC --	⊕ B	3SE5 132-0LA00-1CA0	1	1 unit	102
	Slow-action contacts with make-before-break	1 NO + 2 NC --	⊕ B	3SE5 132-0MA00-1CA0	1	1 unit	102
	Slow-action contacts	2 NO + 1 NC --	⊕ B	3SE5 132-0PA00-1CA0	1	1 unit	102
With M12 connector socket, 4-pole (250 V, 4 A)							
 With M12 socket	Slow-action contacts	1 NO + 1 NC --	⊕ B	3SE5 134-0BA00-1AC4	1	1 unit	102
	Snap-action contacts	1 NO + 1 NC --	⊕ B	3SE5 134-0CA00-1AC4	1	1 unit	102
	Slow-action contacts	2 NC --	⊕ B	3SE5 134-0KA00-1AE0	1	1 unit	102
	Snap-action contacts	2 NC --	⊕ B	3SE5 134-0LA00-1AE0	1	1 unit	102
With 2 LEDs, yellow/green							
 With 2 LEDs	Slow-action contacts	1 NO + 2 NC 24 V DC	⊕ B	3SE5 132-1KA00	1	1 unit	102
	Snap-action contacts	1 NO + 2 NC 24 V DC	⊕ B	3SE5 132-1LA00	1	1 unit	102
	Slow-action contacts	1 NO + 2 NC 230 V AC	⊕ C	3SE5 132-3KA00	1	1 unit	102
	Snap-action contacts	1 NO + 2 NC 230 V AC	⊕ C	3SE5 132-3LA00	1	1 unit	102











⊕ Positive opening according to IEC 60947-5-1, Appendix K, or positively driven actuator, necessary in safety circuits.

¹⁾ Use corresponding high-grade steel lever.

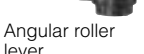
Note: For selection aid, see page 9/12.

3SE5, 3SE2 Position Switches

3SE5, molded-plastic enclosures Enclosure width 40 mm according to EN 50041

Version	Diameter	DT	Modular system	PU (UNIT, SET, M)	PS*	PG
	mm		Order No.	Price per PU		
Operating mechanisms						
 Plain plunger	Plain plungers High-grade steel plungers	10	⊕ A	3SE5 000-0AB01	1	1 unit 102
 Plunger	Rounded plungers, type B acc. to EN 50041 Plastic plungers	10	⊕ A	3SE5 000-0AC03	1	1 unit 102
 Plunger	Roller plungers, type C acc. to EN 50041 High-grade steel lever, plastic roller Plastic plunger, high-grade steel roller	13 13	⊕ A ⊕ A	3SE5 000-0AD05 3SE5 000-0AD06	1 1	1 unit 102 1 unit 102
 Roller lever	Roller levers Metal lever with plastic roller, plastic base	22	⊕ A	3SE5 000-0AE05	1	1 unit 102
 Angular roller lever	Angular roller levers Metal lever with plastic roller, plastic base	22	⊕ A	3SE5 000-0AF05	1	1 unit 102
 Spring rod	Spring rods (for switches with snap-action contacts only) Plastic plunger: • Length 142.5 mm (spring 50 mm, plunger 50 mm) • Length 76 mm (spring 23.5 mm, plunger 10 mm) • Length 242.5 mm (spring 150 mm, plunger 50 mm) High-grade steel plunger: • Length 142.5 mm (spring 50 mm, plunger 50 mm)		B B B B	3SE5 000-0AR01 3SE5 000-0AR03 3SE5 000-0AR04 3SE5 000-0AR02	1 1 1 1	1 unit 102 1 unit 102 1 unit 102 1 unit 102
Twist actuators						
 Twist actuator	Twist actuators, plastic (without lever) • For twist levers and rod actuators, switching right and/or left, adjustable		⊕ A	3SE5 000-0AJ00	1	1 unit 102
 Twist lever	Levers for twist actuators Twist levers, offset, type A acc. to EN 50041 Metal lever 27 mm, plastic roller Metal lever 27 mm, high-grade steel roller Metal lever 27 mm, roller with ball bearing Metal lever 27 mm, 2 plastic rollers Metal lever 27 mm, plastic roller Metal lever 27 mm, rubber roller High-grade steel lever 27 mm, plastic roller High-grade steel lever 27 mm, high-grade steel roller Metal lever 35 mm, plastic roller	19 19 19 19 30 50 19 19 19	⊕ A ⊕ A ⊕ B ⊕ B ⊕ B ⊕ B ⊕ B ⊕ B ⊕ B	3SE5 000-0AA01 3SE5 000-0AA02 3SE5 000-0AA03 3SE5 000-0AA04 3SE5 000-0AA05 3SE5 000-0AA08 3SE5 000-0AA11 3SE5 000-0AA12 3SE5 000-0AA15	1 1 1 1 1 1 1 1 1	1 unit 102 1 unit 102 1 unit 102 1 unit 102 1 unit 102 1 unit 102 1 unit 102 1 unit 102 1 unit 102
 Twist lever, adjustable length	Twist levers 30 mm, straight¹⁾ Metal lever, plastic roller Metal lever, plastic roller	19 30	⊕ B ⊕ B	3SE5 000-0AA24 3SE5 000-0AA26	1 1	1 unit 102 1 unit 102
 Rod actuator	Twist levers, adjustable length, with grid hole Metal lever, plastic roller Metal lever, high-grade steel roller Metal lever, rubber roller High-grade steel lever, plastic roller High-grade steel lever, high-grade steel roller	19 19 50 19 19	⊕ B ⊕ B ⊕ B ⊕ B ⊕ B	3SE5 000-0AA60 3SE5 000-0AA61 3SE5 000-0AA68 3SE5 000-0AA62 3SE5 000-0AA63	1 1 1 1 1	1 unit 102 1 unit 102 1 unit 102 1 unit 102 1 unit 102
	Twist levers, adjustable length Metal lever, plastic roller Metal lever, high-grade steel roller Metal lever, plastic roller Metal lever, rubber roller High-grade steel lever, plastic roller High-grade steel lever, high-grade steel roller	19 19 30 50 19 19	A B B B B B	3SE5 000-0AA50 3SE5 000-0AA51 3SE5 000-0AA55 3SE5 000-0AA58 3SE5 000-0AA52 3SE5 000-0AA53	1 1 1 1 1 1	1 unit 102 1 unit 102 1 unit 102 1 unit 102 1 unit 102 1 unit 102
	Rod actuators, type D acc. to EN 50041 Aluminum rod, length 200 mm Spring rod, length 200 mm Plastic rod, length 200 mm	6 6 6	B B B	3SE5 000-0AA80 3SE5 000-0AA81 3SE5 000-0AA82	1 1 1	1 unit 102 1 unit 102 1 unit 102





⊕ Positively driven actuator, necessary in safety circuits.

¹⁾ Can be clinch mounted (turned through 180°, rear of lever).* You can order this quantity or a multiple thereof.
Illustrations are approximate

Selection and ordering data

Complete units

2 or 3 contacts · Degree of protection IP66/IP67 · Cable entry 2 × (M20 × 1.5)

Version	Contacts	LEDs	DT	Complete units	PU (UNIT, SET, M)	PS*	PG
				Order No.	Price per PU		
Complete units¹⁾ • Enclosure width 50 mm							
Rounded plungers							
 Rounded plunger	With teflon plunger						
	Slow-action contacts	1 NO + 1 NC --	⊕ A	3SE5 242-0BC05	1	1 unit	102
	Snap-action contacts	1 NO + 1 NC --	⊕ B	3SE5 242-0CC05	1	1 unit	102
	Snap-action contacts, integrated ²⁾	1 NO + 1 NC --	⊕ ►	3SE5 242-0HC05	1	1 unit	102
	Snap-action contacts • Short-stroke, integrated ²⁾	1 NO + 1 NC --	⊕ B	3SE5 242-0FC05	1	1 unit	102
	Snap-action contacts • 2 × 2 mm contact gap	1 NO + 1 NC --	⊕ B	3SE5 242-0GC05	1	1 unit	102
	Slow-action contacts	1 NO + 2 NC --	⊕ B	3SE5 242-0KC05	1	1 unit	102
	Snap-action contacts	1 NO + 2 NC --	⊕ B	3SE5 242-0LC05	1	1 unit	102
	Slow-action contacts with make-before-break	1 NO + 2 NC --	⊕ A	3SE5 242-0MC05	1	1 unit	102
	Slow-action contacts	2 NO + 1 NC --	⊕ A	3SE5 242-0PC05	1	1 unit	102
 With increased corrosion protection	With increased corrosion protection						
	Slow-action contacts	1 NO + 1 NC --	⊕ B	3SE5 242-0BC05-1CA0	1	1 unit	102
	Snap-action contacts, integrated ²⁾	1 NO + 1 NC --	⊕ B	3SE5 242-0HC05-1CA0	1	1 unit	102
	Slow-action contacts	1 NO + 2 NC --	⊕ B	3SE5 242-0KC05-1CA0	1	1 unit	102
	Snap-action contacts	1 NO + 2 NC --	⊕ B	3SE5 242-0LC05-1CA0	1	1 unit	102
	Slow-action contacts with make-before-break	1 NO + 2 NC --	⊕ B	3SE5 242-0MC05-1CA0	1	1 unit	102
Slow-action contacts	2 NO + 1 NC --	⊕ B	3SE5 242-0PC05-1CA0	1	1 unit	102	
 With 2 LEDs	With 2 LEDs, yellow/green						
	Slow-action contacts	1 NO + 2 NC 24 V DC	⊕ B	3SE5 242-1KC05	1	1 unit	102
	Snap-action contacts	1 NO + 2 NC 24 V DC	⊕ B	3SE5 242-1LC05	1	1 unit	102
	Slow-action contacts	1 NO + 2 NC 230 V AC	⊕ B	3SE5 242-3KC05	1	1 unit	102
Snap-action contacts	1 NO + 2 NC 230 V AC	⊕ B	3SE5 242-3LC05	1	1 unit	102	
 Roller plunger	Roller plungers						
	With plastic roller 10 mm						
	Slow-action contacts	1 NO + 1 NC --	⊕ B	3SE5 242-0BD03	1	1 unit	102
	Snap-action contacts, integrated ²⁾	1 NO + 1 NC --	⊕ B	3SE5 242-0HD03	1	1 unit	102
Snap-action contacts	1 NO + 2 NC --	⊕ B	3SE5 242-0LD03	1	1 unit	102	

⊕ Positive opening according to IEC 60947-5-1, Appendix K.

1) Popular versions.

2) Subsequent replacement of contact blocks is not possible.



3SE5, 3SE2 Position Switches

3SE5, molded-plastic enclosures Enclosure width 50 mm

2 or 3 contacts · Degree of protection IP66/IP67 · Cable entry 2 × (M20 × 1.5)

Version	Contacts	LEDs	DT	Complete units	<input type="checkbox"/>	PU (UNIT, SET, M)	PS*	PG
				Order No.	Price per PU			

Complete units¹⁾ · Enclosure width 50 mm

	Roller levers							
	With metal lever and plastic roller 13 mm							
	Slow-action contacts	1 NO + 1 NC --	⊕ B	3SE5 242-0BE10		1	1 unit	102
	Snap-action contacts, integrated ²⁾	1 NO + 1 NC --	⊕ A	3SE5 242-0HE10		1	1 unit	102
	Snap-action contacts	1 NO + 2 NC --	⊕ B	3SE5 242-0LE10		1	1 unit	102
Roller lever	With M12 connector socket, 4-pole right (250 V, 4 A)							
	Snap-action contacts	2 NC --	⊕ B	3SE5 244-0LE10-1AE0		1	1 unit	102
	Twist levers							
	With metal lever 21 mm and plastic roller 19 mm							
	Slow-action contacts	1 NO + 1 NC --	⊕ B	3SE5 242-0BK21		1	1 unit	102
	Snap-action contacts, integrated ²⁾	1 NO + 1 NC --	⊕ B	3SE5 242-0HK21		1	1 unit	102
	Snap-action contacts	1 NO + 2 NC --	⊕ B	3SE5 242-0LK21		1	1 unit	102
Twist lever	Twist levers, adjustable length							
	With metal lever and plastic roller 19 mm							
	Snap-action contacts, integrated ²⁾	1 NO + 1 NC --	B	3SE5 242-0HK50		1	1 unit	102
								
Twist lever, adjustable length								

⊕ Positive opening according to IEC 60947-5-1, Appendix K.

¹⁾ Popular versions.

²⁾ Subsequent replacement of contact blocks is not possible.



Note: If the device you require is not available as a complete unit, see "Modular system" on the next page.

3SE5, 3SE2 Position Switches

3SE5, molded-plastic enclosures
Enclosure width 50 mm

Modular system

2 or 3 contacts · Degree of protection IP66/IP67 · Cable entry 2 × (M20 × 1.5)

Version	Contacts	LEDs	DT	Modular system	PU (UNIT, SET, M)	PS*	PG
				Order No.	Price per PU		
Basic switches • Enclosure width 50 mm (with rounded plunger¹⁾)							
	With teflon plunger						
	Slow-action contacts	1 NO + 1 NC --	⊕ A	3SE5 242-0BC05	1	1 unit	102
	Snap-action contacts	1 NO + 1 NC --	⊕ B	3SE5 242-0CC05	1	1 unit	102
	Snap-action contacts, integrated ²⁾	1 NO + 1 NC --	⊕ ▶	3SE5 242-0HC05	1	1 unit	102
	Snap-action contacts • Short-stroke, integrated ²⁾	1 NO + 1 NC --	⊕ B	3SE5 242-0FC05	1	1 unit	102
	Snap-action contacts • 2 × 2 mm contact gap	1 NO + 1 NC --	⊕ B	3SE5 242-0GC05	1	1 unit	102
	Slow-action contacts	1 NO + 2 NC --	⊕ B	3SE5 242-0KC05	1	1 unit	102
	Snap-action contacts	1 NO + 2 NC --	⊕ B	3SE5 242-0LC05	1	1 unit	102
	Slow-action contacts with make-before-break	1 NO + 2 NC --	⊕ A	3SE5 242-0MC05	1	1 unit	102
	Slow-action contacts	2 NO + 1 NC --	⊕ A	3SE5 242-0PC05	1	1 unit	102
	With increased corrosion protection³⁾						
	Slow-action contacts	1 NO + 1 NC --	⊕ B	3SE5 242-0BC05-1CA0	1	1 unit	102
	Snap-action contacts, integrated ²⁾	1 NO + 1 NC --	⊕ B	3SE5 242-0HC05-1CA0	1	1 unit	102
	Slow-action contacts	1 NO + 2 NC --	⊕ B	3SE5 242-0KC05-1CA0	1	1 unit	102
	Snap-action contacts	1 NO + 2 NC --	⊕ B	3SE5 242-0LC05-1CA0	1	1 unit	102
	Slow-action contacts with make-before-break	1 NO + 2 NC --	⊕ B	3SE5 242-0MC05-1CA0	1	1 unit	102
	With 2 LEDs, yellow/green						
	Slow-action contacts	1 NO + 2 NC 24 V DC	⊕ B	3SE5 242-1KC05	1	1 unit	102
	Snap-action contacts	1 NO + 2 NC 24 V DC	⊕ B	3SE5 242-1LC05	1	1 unit	102
	Slow-action contacts	1 NO + 2 NC 230 V AC	⊕ B	3SE5 242-3KC05	1	1 unit	102
	Snap-action contacts	1 NO + 2 NC 230 V AC	⊕ B	3SE5 242-3LC05	1	1 unit	102



⊕ Positive opening according to IEC 60947-5-1, Appendix K, or positively driven actuator, necessary in safety circuits.

1) On the plastic version the basic switch is a complete unit with rounded plunger.

2) Subsequent replacement of contact blocks is not possible.

3) Use corresponding high-grade steel lever.









Note: For selection aid, see page 9/12.

Version	Diameter	DT	Modular system	PU (UNIT, SET, M)	PS*	PG	
			Order No.	Price per PU			
Operating mechanisms							
	Roller plungers, type C acc. to EN 50047						
	Plastic rollers	10	⊕ A	3SE5 000-0AD03	1	1 unit	102
	High-grade steel rollers	10	⊕ B	3SE5 000-0AD04	1	1 unit	102
	Roller plungers with central fixing						
	Plastic rollers	10	⊕ B	3SE5 000-0AD10	1	1 unit	102
	High-grade steel rollers	10	⊕ B	3SE5 000-0AD11	1	1 unit	102

⊕ Positively driven actuator, necessary in safety circuits.

3SE5, 3SE2 Position Switches

3SE5, molded-plastic enclosures Enclosure width 50 mm

Version	Diameter	DT	Modular system	PU (UNIT, SET, M)	PS*	PG	
	mm		Order No.	Price per PU			
Operating mechanisms							
	Roller levers, type E acc. to EN 50047						
	Metal lever, plastic roller	13	⊕ A	3SE5 000-0AE10	1	1 unit 102	
	Metal lever, high-grade steel roller	13	⊕ B	3SE5 000-0AE11	1	1 unit 102	
	High-grade steel lever, plastic roller	13	⊕ B	3SE5 000-0AE12	1	1 unit 102	
	Angular roller levers						
	Metal lever, plastic roller	13	⊕ A	3SE5 000-0AF10	1	1 unit 102	
	Metal lever, high-grade steel roller	13	⊕ B	3SE5 000-0AF11	1	1 unit 102	
	High-grade steel lever, plastic roller	13	⊕ A	3SE5 000-0AF12	1	1 unit 102	
	Spring rods (for switches with snap-action contacts only)						
	Plastic plunger:						
	• Length 142.5 mm (spring 50 mm, plunger 50 mm)		B	3SE5 000-0AR01	1	1 unit 102	
	• Length 76 mm (spring 23.5 mm, plunger 10 mm)		B	3SE5 000-0AR03	1	1 unit 102	
	• Length 242.5 mm (spring 150 mm, plunger 50 mm)		B	3SE5 000-0AR04	1	1 unit 102	
High-grade steel plunger:							
• Length 142.5 mm (spring 50 mm, plunger 50 mm)		B	3SE5 000-0AR02	1	1 unit 102		
Twist actuators							
	Twist actuators, plastic (without lever)						
	Switching right and/or left, adjustable		⊕ A	3SE5 000-0AK00	1	1 unit 102	
	Levers for twist actuators						
	Twist levers 21 mm, straight, type A acc. to EN 50047						
	Metal lever, plastic roller	19	⊕ A	3SE5 000-0AA21	1	1 unit 102	
	Metal lever, high-grade steel roller	19	⊕ B	3SE5 000-0AA22	1	1 unit 102	
	Metal lever, roller with ball bearing	19	⊕ B	3SE5 000-0AA23	1	1 unit 102	
	Metal lever, plastic roller	30	⊕ B	3SE5 000-0AA25	1	1 unit 102	
	High-grade steel lever, plastic roller	19	⊕ B	3SE5 000-0AA31	1	1 unit 102	
	High-grade steel lever, high-grade steel roller	19	⊕ B	3SE5 000-0AA32	1	1 unit 102	
	Twist levers 30 mm, straight¹⁾						
	Metal lever, plastic roller	19	⊕ B	3SE5 000-0AA24	1	1 unit 102	
	Metal lever, plastic roller	30	⊕ B	3SE5 000-0AA26	1	1 unit 102	
	Twist levers, adjustable length, with grid hole						
	Metal lever, plastic roller	19	⊕ B	3SE5 000-0AA60	1	1 unit 102	
	Metal lever, high-grade steel roller	19	⊕ B	3SE5 000-0AA61	1	1 unit 102	
	Metal lever, plastic roller	50	⊕ B	3SE5 000-0AA67	1	1 unit 102	
	Metal lever, rubber roller	50	⊕ B	3SE5 000-0AA68	1	1 unit 102	
	High-grade steel lever, plastic roller	19	⊕ B	3SE5 000-0AA62	1	1 unit 102	
	High-grade steel lever, high-grade steel roller	19	⊕ B	3SE5 000-0AA63	1	1 unit 102	
	Twist levers, adjustable length						
Metal lever, plastic roller	19	A	3SE5 000-0AA50	1	1 unit 102		
Metal lever, high-grade steel roller	19	B	3SE5 000-0AA51	1	1 unit 102		
Metal lever, plastic roller	30	B	3SE5 000-0AA55	1	1 unit 102		
Metal lever, plastic roller	50	B	3SE5 000-0AA57	1	1 unit 102		
Metal lever, rubber roller	50	B	3SE5 000-0AA58	1	1 unit 102		
High-grade steel lever, plastic roller	19	B	3SE5 000-0AA52	1	1 unit 102		
High-grade steel lever, high-grade steel roller	19	B	3SE5 000-0AA53	1	1 unit 102		
	Rod actuators						
	Aluminum rod, length 200 mm	6	B	3SE5 000-0AA80	1	1 unit 102	
	Spring rod, length 200 mm	6	B	3SE5 000-0AA81	1	1 unit 102	
	Plastic rod, length 200 mm	6	B	3SE5 000-0AA82	1	1 unit 102	

⊕ Positively driven actuator, necessary in safety circuits.



¹⁾ Can be clinch mounted (turned through 180°, rear of lever).

3SE5, molded-plastic enclosures
Ambient temperature up to -40 °C

Selection and ordering data



Complete units

2 or 3 contacts · Degree of protection IP65 or IP66/IP67 · Cable entry M20 × 1.5

Version	Contacts	LEDs	DT	Complete units	PU (UNIT, SET, M)	PS*	PG
				Order No.	Price per PU		
Complete units¹⁾ • Enclosure width 31 mm							
	Twist levers, type A acc. to EN 50047 With high-grade steel lever 21 mm and plastic roller 19 mm						
Twist lever	Snap-action contacts	1 NO + 1 NC --	⊕ A	3SE5 232-0CK31-1AJ0	1	1 unit	102
	Twist levers, adjustable length With high-grade steel lever with grid hole and plastic roller 19 mm						
Twist lever, adjustable length	Snap-action contacts	1 NO + 1 NC --	⊕ A	3SE5 232-0CK62-1AJ0	1	1 unit	102
	Snap-action contacts	1 NO + 2 NC --	⊕ B	3SE5 232-0LK62-1AJ0	1	1 unit	102
Complete units¹⁾ • Enclosure width 50 mm							
	Twist levers With metal lever 21 mm and plastic roller 19 mm						
Twist lever, adjustable length	Snap-action contacts, integrated ²⁾	1 NO + 1 NC --	⊕ B	3SE5 242-0HK21-1AJ0	1	1 unit	102
	Twist levers, adjustable length With high-grade steel lever with grid hole and plastic roller 19 mm						
	Snap-action contacts, integrated ²⁾	1 NO + 1 NC --	⊕ B	3SE5 242-0HK62-1AJ0	1	1 unit	102

Modular system

2 or 3 contacts · Degree of protection IP65 or IP66/IP67 · Cable entry M20 × 1.5

Version	Contacts	LEDs	DT	Modular system	PU (UNIT, SET, M)	PS*	PG
				Order No.	Price per PU		
Basic switches • Enclosure width 31 mm (with rounded plunger¹⁾)							
	With teflon plunger						
Basic switch	Snap-action contacts	1 NO + 1 NC --	⊕ B	3SE5 232-0CC05-1AJ0	1	1 unit	102
	Slow-action contacts	1 NO + 2 NC --	⊕ B	3SE5 232-0KC05-1AJ0	1	1 unit	102
	Snap-action contacts	1 NO + 2 NC --	⊕ B	3SE5 232-0LC05-1AJ0	1	1 unit	102
Basic switches • Enclosure width 50 mm (with rounded plunger¹⁾)							
	With teflon plunger						
Basic switch	Slow-action contacts	1 NO + 1 NC --	⊕ B	3SE5 242-0BC05-1AJ0	1	1 unit	102
	Snap-action contacts, integrated ²⁾	1 NO + 1 NC --	⊕ B	3SE5 242-0HC05-1AJ0	1	1 unit	102

⊕ Positive opening according to IEC 60947-5-1, Appendix K, or positively driven actuator, necessary in safety circuits.







1) On the plastic version the basic switch is a complete unit with rounded plunger.

2) Subsequent replacement of contact blocks is not possible.

Note: For selection aid, see page 9/12.

3SE5, 3SE2 Position Switches

3SE5, molded-plastic enclosures
Ambient temperature up to -40 °C







Version	Diameter	DT	Modular system	PU (UNIT, SET, M)	PS*	PG
	mm		Order No.	Price per PU		
Operating mechanisms						
	Roller plungers, type C acc. to EN 50047					
Roller plunger	Plastic rollers	10	⊕ B	3SE5 000-0AD03-1AJ0	1	1 unit 102
	Roller levers, type E acc. to EN 50047					
Roller lever	Metal lever, plastic roller	13	⊕ B	3SE5 000-0AE10-1AJ0	1	1 unit 102
	High-grade steel lever, plastic roller	13	⊕ B	3SE5 000-0AE12-1AJ0	1	1 unit 102
	Angular roller levers					
Angular roller lever	Metal lever, plastic roller	13	⊕ B	3SE5 000-0AF10-1AJ0	1	1 unit 102
	High-grade steel lever, plastic roller	13	⊕ B	3SE5 000-0AF12-1AJ0	1	1 unit 102
Twist actuators						
	Twist actuators, plastic (without lever)					
Twist actuator	Switching right and/or left, adjustable		⊕ B	3SE5 000-0AK00-1AJ0	1	1 unit 102
Levers for twist actuators						
	Twist levers straight, 21 mm, type A acc. to EN 50047					
Twist lever	Metal lever, plastic roller	19	⊕ B	3SE5 000-0AA21-1AJ0	1	1 unit 102
	High-grade steel lever, plastic roller	19	⊕ B	3SE5 000-0AA31-1AJ0	1	1 unit 102
	Twist levers, adjustable length, with grid hole					
Twist lever, adjustable length	Metal lever, plastic roller	19	⊕ B	3SE5 000-0AA60-1AJ0	1	1 unit 102
	High-grade steel lever, plastic roller	19	⊕ B	3SE5 000-0AA62-1AJ0	1	1 unit 102

⊕ Positively driven actuator, necessary in safety circuits.

Selection and ordering data

Complete units

2 or 3 contacts · Degree of protection IP66/IP67 · Cable entry M20 × 1.5

Version	Contacts	LEDs	DT	Complete units	PU (UNIT, SET, M)	PS*	PG
				Order No.	Price per PU		
Complete units¹⁾ · Enclosure width 31 mm							
Rounded plungers, type B, acc. to EN 50047							
 Rounded plunger	With plunger						
	Slow-action contacts	1 NO + 1 NC --	⊕ A	3SE5 212-0BC05	1	1 unit	102
	Snap-action contacts	1 NO + 1 NC --	⊕ A	3SE5 212-0CC05	1	1 unit	102
	Slow-action contacts	1 NO + 2 NC --	⊕ A	3SE5 212-0KC05	1	1 unit	102
	Snap-action contacts	1 NO + 2 NC --	⊕ A	3SE5 212-0LC05	1	1 unit	102
	Slow-action contacts with make-before-break	1 NO + 2 NC --	⊕ A	3SE5 212-0MC05	1	1 unit	102
	Slow-action contacts	2 NO + 1 NC --	⊕ A	3SE5 212-0PC05	1	1 unit	102
 With increased corrosion protection	With increased corrosion protection						
	Slow-action contacts	1 NO + 1 NC --	⊕ B	3SE5 212-0BC05-1CA0	1	1 unit	102
	Snap-action contacts	1 NO + 1 NC --	⊕ B	3SE5 212-0CC05-1CA0	1	1 unit	102
	Slow-action contacts	1 NO + 2 NC --	⊕ B	3SE5 212-0KC05-1CA0	1	1 unit	102
	Snap-action contacts	1 NO + 2 NC --	⊕ B	3SE5 212-0LC05-1CA0	1	1 unit	102
	Slow-action contacts with make-before-break	1 NO + 2 NC --	⊕ B	3SE5 212-0MC05-1CA0	1	1 unit	102
	Slow-action contacts	2 NO + 1 NC --	⊕ B	3SE5 212-0PC05-1CA0	1	1 unit	102
 With 2 LEDs	With M12 connector socket, 5-pole (125 V, 4 A)						
	Slow-action contacts	1 NO + 1 NC --	⊕ B	3SE5 214-0BC05-1AC5	1	1 unit	102
	Snap-action contacts	1 NO + 1 NC --	⊕ B	3SE5 214-0CC05-1AC5	1	1 unit	102
	Slow-action contacts	2 NC --	⊕ B	3SE5 214-0KC05-1AE1	1	1 unit	102
	Snap-action contacts	2 NC --	⊕ B	3SE5 214-0LC05-1AE1	1	1 unit	102
	With 2 LEDs, yellow/green						
	Slow-action contacts	1 NO + 2 NC 24 V DC	⊕ B	3SE5 212-1KC05	1	1 unit	102
Snap-action contacts	1 NO + 2 NC 24 V DC	⊕ A	3SE5 212-1LC05	1	1 unit	102	
Slow-action contacts	1 NO + 2 NC 230 V AC	⊕ B	3SE5 212-3KC05	1	1 unit	102	
Snap-action contacts	1 NO + 2 NC 230 V AC	⊕ B	3SE5 212-3LC05	1	1 unit	102	
 With 2 LEDs	With M12 connector socket, 5-pole (125 V, 4 A) and 2 LEDs						
	Slow-action contacts	1 NO + 1 NC 24 V DC	⊕ B	3SE5 214-1BC05-1AF3	1	1 unit	102
	Snap-action contacts	1 NO + 1 NC 24 V DC	⊕ B	3SE5 214-1CC05-1AF3	1	1 unit	102
Plain plungers							
 Plain plunger	With high-grade steel plunger						
	Slow-action contacts	1 NO + 1 NC --	⊕ B	3SE5 212-0BB01	1	1 unit	102
	Snap-action contacts	1 NO + 1 NC --	⊕ B	3SE5 212-0CB01	1	1 unit	102
	Slow-action contacts	1 NO + 2 NC --	⊕ B	3SE5 212-0KB01	1	1 unit	102
	Snap-action contacts	1 NO + 2 NC --	⊕ B	3SE5 212-0LB01	1	1 unit	102
Roller plungers, type C acc. to EN 50047							
 Roller plunger	With plastic roller 10 mm						
	Slow-action contacts	1 NO + 1 NC --	⊕ A	3SE5 212-0BD03	1	1 unit	102
	Snap-action contacts	1 NO + 1 NC --	⊕ B	3SE5 212-0CD03	1	1 unit	102
	Slow-action contacts	1 NO + 2 NC --	⊕ A	3SE5 212-0KD03	1	1 unit	102
	Snap-action contacts	1 NO + 2 NC --	⊕ B	3SE5 212-0LD03	1	1 unit	102





⊕ Positive opening according to IEC 60947-5-1, Appendix K.

1) Popular versions.

3SE5, 3SE2 Position Switches

3SE5, metal enclosures Enclosure width 31 mm according to EN 50047

2 or 3 contacts · Degree of protection IP66/IP67 · Cable entry M20 × 1.5

Version	Contacts	LEDs	DT	Complete units	<input type="checkbox"/>	PU (UNIT, SET, M)	PS*	PG
				Order No.	Price per PU			
Complete units¹⁾ • Enclosure width 31 mm								
Roller levers, type E acc. to EN 50047								
With metal lever and plastic roller 13 mm								
	Slow-action contacts	1 NO + 1 NC --	⊕ A	3SE5 212-0BE10		1	1 unit	102
	Snap-action contacts	1 NO + 1 NC --	⊕ B	3SE5 212-0CE10		1	1 unit	102
	Slow-action contacts	1 NO + 2 NC --	⊕ B	3SE5 212-0KE10		1	1 unit	102
	Snap-action contacts	1 NO + 2 NC --	⊕ B	3SE5 212-0LE10		1	1 unit	102
Roller lever								
Angular roller levers								
With metal lever and plastic roller 13 mm								
	Slow-action contacts	1 NO + 1 NC --	⊕ B	3SE5 212-0BF10		1	1 unit	102
	Snap-action contacts	1 NO + 1 NC --	⊕ B	3SE5 212-0CF10		1	1 unit	102
	Slow-action contacts	1 NO + 2 NC --	⊕ B	3SE5 212-0KF10		1	1 unit	102
	Snap-action contacts	1 NO + 2 NC --	⊕ B	3SE5 212-0LF10		1	1 unit	102
Angular roller lever								
Twist levers, type A acc. to EN 50047								
With metal lever 21 mm and plastic roller 19 mm								
	Slow-action contacts	1 NO + 1 NC --	⊕ A	3SE5 212-0BK21		1	1 unit	102
	Snap-action contacts	1 NO + 1 NC --	⊕ A	3SE5 212-0CK21		1	1 unit	102
	Slow-action contacts	1 NO + 2 NC --	⊕ B	3SE5 212-0KK21		1	1 unit	102
	Snap-action contacts	1 NO + 2 NC --	⊕ B	3SE5 212-0LK21		1	1 unit	102
Twist lever								
Twist levers, adjustable length								
With metal lever with grid hole and plastic roller 19 mm								
	Snap-action contacts	1 NO + 1 NC --	⊕ A	3SE5 212-0CK60		1	1 unit	102
	Slow-action contacts	1 NO + 2 NC --	⊕ B	3SE5 212-0KK60		1	1 unit	102
	Snap-action contacts	1 NO + 2 NC --	⊕ B	3SE5 212-0LK60		1	1 unit	102
With metal lever and plastic roller 19 mm								
	Slow-action contacts	1 NO + 1 NC --	A	3SE5 212-0BK50		1	1 unit	102
	Snap-action contacts	1 NO + 1 NC --	B	3SE5 212-0CK50		1	1 unit	102
	Snap-action contacts	1 NO + 2 NC --	B	3SE5 212-0LK50		1	1 unit	102
Twist lever, adjustable length								





⊕ Positive opening according to IEC 60947-5-1, Appendix K.

¹⁾ Popular versions.

Note: If the device you require is not available as a complete unit, see "Modular system" on the next page.

3SE5, metal enclosures
Enclosure width 31 mm according to EN 50047
Modular system

2 or 3 contacts · Degree of protection IP66/IP67 · Cable entry M20 × 1.5



Version	Contacts	LEDs	DT	Modular system	PU (UNIT, SET, M)	PS*	PG
				Order No.	Price per PU		
Basic switches • Enclosure width 31 mm (with rounded plunger¹⁾)							
 Basic switch	With plunger						
	Slow-action contacts	1 NO + 1 NC --	⊕ A	3SE5 212-0BC05	1	1 unit	102
	Snap-action contacts	1 NO + 1 NC --	⊕ A	3SE5 212-0CC05	1	1 unit	102
	Slow-action contacts	1 NO + 2 NC --	⊕ A	3SE5 212-0KC05	1	1 unit	102
	Snap-action contacts	1 NO + 2 NC --	⊕ A	3SE5 212-0LC05	1	1 unit	102
	Slow-action contacts with make-before-break	1 NO + 2 NC --	⊕ A	3SE5 212-0MC05	1	1 unit	102
	Slow-action contacts	2 NO + 1 NC --	⊕ A	3SE5 212-0PC05	1	1 unit	102
 With increased corrosion protection	With increased corrosion protection²⁾						
	Slow-action contacts	1 NO + 1 NC --	⊕ B	3SE5 212-0BC05-1CA0	1	1 unit	102
	Snap-action contacts	1 NO + 1 NC --	⊕ B	3SE5 212-0CC05-1CA0	1	1 unit	102
	Slow-action contacts	1 NO + 2 NC --	⊕ B	3SE5 212-0KC05-1CA0	1	1 unit	102
	Snap-action contacts	1 NO + 2 NC --	⊕ B	3SE5 212-0LC05-1CA0	1	1 unit	102
	Slow-action contacts with make-before-break	1 NO + 2 NC --	⊕ B	3SE5 212-0MC05-1CA0	1	1 unit	102
	Slow-action contacts	2 NO + 1 NC --	⊕ B	3SE5 212-0PC05-1CA0	1	1 unit	102
 With M12 socket	With M12 connector socket, 5-pole (125 V, 4 A)						
	Slow-action contacts	1 NO + 1 NC --	⊕ B	3SE5 214-0BC05-1AC5	1	1 unit	102
	Snap-action contacts	1 NO + 1 NC --	⊕ B	3SE5 214-0CC05-1AC5	1	1 unit	102
	Slow-action contacts	2 NC --	⊕ B	3SE5 214-0KC05-1AE1	1	1 unit	102
	Snap-action contacts	2 NC --	⊕ B	3SE5 214-0LC05-1AE1	1	1 unit	102
 With 2 LEDs	With 2 LEDs, yellow/green						
	Slow-action contacts	1 NO + 2 NC 24 V DC	⊕ B	3SE5 212-1KC05	1	1 unit	102
	Snap-action contacts	1 NO + 2 NC 24 V DC	⊕ A	3SE5 212-1LC05	1	1 unit	102
	Slow-action contacts	1 NO + 2 NC 230 V AC	⊕ B	3SE5 212-3KC05	1	1 unit	102
	Snap-action contacts	1 NO + 2 NC 230 V AC	⊕ B	3SE5 212-3LC05	1	1 unit	102
 With M12 socket and 2 LEDs	With M12 connector socket, 5-pole (125 V, 4 A) and 2 LEDs						
	Slow-action contacts	1 NO + 1 NC 24 V DC	⊕ B	3SE5 214-1BC05-1AF3	1	1 unit	102
	Snap-action contacts	1 NO + 1 NC 24 V DC	⊕ B	3SE5 214-1CC05-1AF3	1	1 unit	102

⊕ Positive opening according to IEC 60947-5-1, Appendix K, or positively driven actuator, necessary in safety circuits.

1) On enclosure width 31 mm the basic switch is a complete unit with rounded plunger.

2) Use corresponding high-grade steel lever.











Note: For selection aid, see page 9/12.

Version	Diameter	DT	Modular system	PU (UNIT, SET, M)	PS*	PG
			Order No.	Price per PU		
Operating mechanisms						
 Plain plunger	Plain plungers					
	High-grade steel plungers	10	⊕ A	3SE5 000-0AB01	1	1 unit 102
 Roller plunger	Roller plungers, type C acc. to EN 50047					
	Plastic rollers	10	⊕ A	3SE5 000-0AD03	1	1 unit 102
	High-grade steel rollers	10	⊕ B	3SE5 000-0AD04	1	1 unit 102

* You can order this quantity or a multiple thereof.
Illustrations are approximate

3SE5, 3SE2 Position Switches

3SE5, metal enclosures Enclosure width 31 mm according to EN 50047

Version	Diameter	DT	Modular system	PU (UNIT, SET, M)	PS*	PG
	mm		Order No.	Price per PU		
Operating mechanisms						
	Roller plungers with central fixing					
	Plastic rollers	10	⊕ B	3SE5 000-0AD10	1	1 unit 102
	High-grade steel rollers	10	⊕ B	3SE5 000-0AD11	1	1 unit 102
With central fixing						
	Roller levers, type E acc. to EN 50047					
	Metal lever, plastic roller	13	⊕ A	3SE5 000-0AE10	1	1 unit 102
	Metal lever, high-grade steel roller	13	⊕ B	3SE5 000-0AE11	1	1 unit 102
	High-grade steel lever, plastic roller	13	⊕ B	3SE5 000-0AE12	1	1 unit 102
Roller lever	High-grade steel lever, high-grade steel roller	13	⊕ B	3SE5 000-0AE13	1	1 unit 102
	Angular roller levers					
	Metal lever, plastic roller	13	⊕ A	3SE5 000-0AF10	1	1 unit 102
	Metal lever, high-grade steel roller	13	⊕ B	3SE5 000-0AF11	1	1 unit 102
	High-grade steel lever, plastic roller	13	⊕ A	3SE5 000-0AF12	1	1 unit 102
Angular roller lever	High-grade steel lever, high-grade steel roller	13	⊕ B	3SE5 000-0AF13	1	1 unit 102
	Spring rods (for switches with snap-action contacts only)					
	Plastic plunger:					
	• Length 142.5 mm (spring 50 mm, plunger 50 mm)		B	3SE5 000-0AR01	1	1 unit 102
	• Length 76 mm (spring 23.5 mm, plunger 10 mm)		B	3SE5 000-0AR03	1	1 unit 102
	• Length 242.5 mm (spring 150 mm, plunger 50 mm)		B	3SE5 000-0AR04	1	1 unit 102
High-grade steel plunger:						
• Length 142.5 mm (spring 50 mm, plunger 50 mm)		B	3SE5 000-0AR02	1	1 unit 102	
Spring rod						
Twist actuators						
	Twist actuators, plastic (without lever)					
	Switching right and/or left, adjustable		⊕ A	3SE5 000-0AK00	1	1 unit 102
Twist actuator	Levers for twist actuators					
	Twist levers, straight, type A acc. to EN 50047					
	Metal lever 21 mm, plastic roller	19	⊕ A	3SE5 000-0AA21	1	1 unit 102
	Metal lever 21 mm, high-grade steel roller	19	⊕ B	3SE5 000-0AA22	1	1 unit 102
	Metal lever 21 mm, roller with ball bearing	19	⊕ B	3SE5 000-0AA23	1	1 unit 102
	Metal lever 21 mm, plastic roller	30	⊕ B	3SE5 000-0AA25	1	1 unit 102
	High-grade steel lever 21 mm, plastic roller	19	⊕ B	3SE5 000-0AA31	1	1 unit 102
Twist lever	High-grade steel lever 21 mm, high-grade steel roller	19	⊕ B	3SE5 000-0AA32	1	1 unit 102
	Twist levers 30 mm, straight¹⁾					
	Metal lever, plastic roller	19	⊕ B	3SE5 000-0AA24	1	1 unit 102
	Metal lever, plastic roller	30	⊕ B	3SE5 000-0AA26	1	1 unit 102
	Twist levers, adjustable length, with grid hole					
	Metal lever, plastic roller	19	⊕ B	3SE5 000-0AA60	1	1 unit 102
	Metal lever, high-grade steel roller	19	⊕ B	3SE5 000-0AA61	1	1 unit 102
	Metal lever, plastic roller	50	⊕ B	3SE5 000-0AA67	1	1 unit 102
	Metal lever, rubber roller	50	⊕ B	3SE5 000-0AA68	1	1 unit 102
	High-grade steel lever, plastic roller	19	⊕ B	3SE5 000-0AA62	1	1 unit 102
	High-grade steel lever, high-grade steel roller	19	⊕ B	3SE5 000-0AA63	1	1 unit 102
	Twist levers, adjustable length					
	Metal lever, plastic roller	19	A	3SE5 000-0AA50	1	1 unit 102
	Metal lever, high-grade steel roller	19	B	3SE5 000-0AA51	1	1 unit 102
	Metal lever, plastic roller	30	B	3SE5 000-0AA55	1	1 unit 102
	Metal lever, plastic roller	50	B	3SE5 000-0AA57	1	1 unit 102
	Metal lever, rubber roller	50	B	3SE5 000-0AA58	1	1 unit 102
	High-grade steel lever, plastic roller	19	B	3SE5 000-0AA52	1	1 unit 102
	High-grade steel lever, high-grade steel roller	19	B	3SE5 000-0AA53	1	1 unit 102
		Rod actuators, type D acc. to EN 50041				
Aluminum rod, length 200 mm		6	B	3SE5 000-0AA80	1	1 unit 102
Spring rod, length 200 mm		6	B	3SE5 000-0AA81	1	1 unit 102
Plastic rod, length 200 mm		6	B	3SE5 000-0AA82	1	1 unit 102
	Plastic rod, length 330 mm	6	B	3SE5 000-0AA83	1	1 unit 102
Rod actuator						



⊕ Positively driven actuator, necessary in safety circuits.

¹⁾ Can be clinch mounted (turned through 180°, rear of lever).

Selection and ordering data

Complete units

2 or 3 contacts · Degree of protection IP66/IP67 · Cable entry M20 × 1.5

Version	Contacts	LEDs	DT	Complete units	PU (UNIT, SET, M)	PS*	PG
				Order No.	Price per PU		
Complete units¹⁾ · Enclosure width 40 mm							
Plain plungers							
	With high-grade steel plunger						
Plain plunger	Slow-action contacts	1 NO + 1 NC --	⊕ A	3SE5 112-0BB01	1	1 unit	102
	Snap-action contacts	1 NO + 1 NC --	⊕ A	3SE5 112-0CB01	1	1 unit	102
	Slow-action contacts	1 NO + 2 NC --	⊕ B	3SE5 112-0KB01	1	1 unit	102
	Snap-action contacts	1 NO + 2 NC --	⊕ B	3SE5 112-0LB01	1	1 unit	102
Rounded plungers, type B acc. to EN 50041							
	With high-grade steel plungers, with 3 mm overtravel						
Rounded plunger	Slow-action contacts	1 NO + 1 NC --	⊕ B	3SE5 112-0BC02	1	1 unit	102
	Snap-action contacts	1 NO + 1 NC --	⊕ ▶	3SE5 112-0CC02	1	1 unit	102
	Slow-action contacts	1 NO + 2 NC --	⊕ B	3SE5 112-0KC02	1	1 unit	102
	Snap-action contacts	1 NO + 2 NC --	⊕ B	3SE5 112-0LC02	1	1 unit	102
Roller plungers, type C acc. to EN 50041							
	With high-grade steel roller 13 mm, with 3 mm overtravel						
Roller plunger	Slow-action contacts	1 NO + 1 NC --	⊕ B	3SE5 112-0BD02	1	1 unit	102
	Snap-action contacts	1 NO + 1 NC --	⊕ ▶	3SE5 112-0CD02	1	1 unit	102
	Slow-action contacts	1 NO + 2 NC --	⊕ B	3SE5 112-0KD02	1	1 unit	102
	Snap-action contacts	1 NO + 2 NC --	⊕ B	3SE5 112-0LD02	1	1 unit	102
With M12 connector socket, 5-pole (125 V, 4 A)							
	Snap-action contacts	1 NO + 1 NC 24 V DC	⊕ B	3SE5 114-1CD02-1AF3	1	1 unit	102
Roller levers							
	With metal lever and plastic roller 22 mm						
Roller lever	Slow-action contacts	1 NO + 1 NC --	⊕ B	3SE5 112-0BE01	1	1 unit	102
	Snap-action contacts	1 NO + 1 NC --	⊕ ▶	3SE5 112-0CE01	1	1 unit	102
	Slow-action contacts	1 NO + 2 NC --	⊕ B	3SE5 112-0KE01	1	1 unit	102
	Snap-action contacts	1 NO + 2 NC --	⊕ B	3SE5 112-0LE01	1	1 unit	102
Angular roller levers							
	With metal lever and plastic roller 22 mm						
Angular roller lever	Slow-action contacts	1 NO + 1 NC --	⊕ B	3SE5 112-0BF01	1	1 unit	102
	Snap-action contacts	1 NO + 1 NC --	⊕ A	3SE5 112-0CF01	1	1 unit	102
	Snap-action contacts	1 NO + 2 NC --	⊕ B	3SE5 112-0LF01	1	1 unit	102
Spring rods							
	Length 142.5 mm, with plastic plunger 50 mm						
Spring rod	Snap-action contacts	1 NO + 1 NC --	▶	3SE5 112-0CR01	1	1 unit	102

⊕ Positive opening according to IEC 60947-5-1, Appendix K.

1) Popular versions.

* You can order this quantity or a multiple thereof.
Illustrations are approximate









3SE5, 3SE2 Position Switches

3SE5, metal enclosures Enclosure width 40 mm according to EN 50041

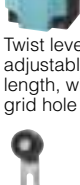
2 or 3 contacts · Degree of protection IP66/IP67 · Cable entry M20 × 1.5

Version	Contacts	LEDs	DT	Complete units	<input type="checkbox"/>	PU (UNIT, SET, M)	PS*	PG
				Order No.	Price per PU			

Complete units¹⁾ · Enclosure width 40 mm

	Twist levers, type A acc. to EN 50041								
	With metal lever 27 mm and plastic roller 19 mm								
	Slow-action contacts	1 NO + 1 NC --		⊕ B	3SE5 112-0BH01		1	1 unit	102
	Snap-action contacts	1 NO + 1 NC --		⊕ ▶	3SE5 112-0CH01		1	1 unit	102
	Slow-action contacts	1 NO + 2 NC --		⊕ B	3SE5 112-0KH01		1	1 unit	102
	Snap-action contacts	1 NO + 2 NC --		⊕ B	3SE5 112-0LH01		1	1 unit	102
	With M12 connector socket, 5-pole (125 V, 4 A)								
	Snap-action contacts	1 NO + 1 NC --		⊕ A	3SE5 114-0CH01-1AC5		1	1 unit	102
	With M12 connector socket, 5-pole (125 V, 4 A) and 2 LEDs								
	Snap-action contacts	1 NO + 1 NC 24 V DC		⊕ B	3SE5 114-1CH01-1AF3		1	1 unit	102
	With metal lever 27 mm and high-grade steel roller 19 mm								
	Slow-action contacts	1 NO + 1 NC --		⊕ B	3SE5 112-0BH02		1	1 unit	102
	Snap-action contacts	1 NO + 1 NC --		⊕ A	3SE5 112-0CH02		1	1 unit	102
	With M12 connector socket, 5-pole (125 V, 4 A) and 2 LEDs								
	Snap-action contacts	1 NO + 1 NC --		⊕ B	3SE5 114-1CH02-1AF3		1	1 unit	102
	With metal lever 30 mm and plastic roller 19 mm								
	Snap-action contacts	1 NO + 1 NC --		⊕ ▶	3SE5 112-0CH24		1	1 unit	102
	Twist levers, adjustable length								
	With metal lever with grid hole and plastic roller 19 mm								
	Slow-action contacts	1 NO + 1 NC --		⊕ B	3SE5 112-0BH60		1	1 unit	102
	Snap-action contacts	1 NO + 1 NC --		⊕ ▶	3SE5 112-0CH60		1	1 unit	102
	Snap-action contacts	1 NO + 2 NC --		⊕ B	3SE5 112-0LH60		1	1 unit	102
	With metal lever and plastic roller 19 mm								
	Slow-action contacts	1 NO + 1 NC --		B	3SE5 112-0BH50		1	1 unit	102
	Snap-action contacts	1 NO + 1 NC --		▶	3SE5 112-0CH50		1	1 unit	102
	Snap-action contacts	1 NO + 2 NC --		B	3SE5 112-0LH50		1	1 unit	102
	With M12 connector socket, 8-pole (30 V, 2 A) and 2 LEDs								
	Snap-action contacts	1 NO + 2 NC 24 V DC		⊕ B	3SE5 114-1LH50-1AD4		1	1 unit	102
	With metal lever and high-grade steel roller 19 mm								
	Snap-action contacts	1 NO + 1 NC --		B	3SE5 112-0CH51		1	1 unit	102
	Fork levers, latching								
	With metal lever and 2 plastic rollers 19 mm								
	Snap-action contacts	1 NO + 1 NC --		⊕ B	3SE5 112-0CT11		1	1 unit	102
	Rod actuators, type D, acc. to EN 50041								
	With aluminum rod, length 200 mm								
	Snap-action contacts	1 NO + 1 NC --		▶	3SE5 112-0CH80		1	1 unit	102
	With plastic rod, length 200 mm								
	Snap-action contacts	1 NO + 1 NC --		B	3SE5 112-0CH82		1	1 unit	102

⊕ Positive opening according to IEC 60947-5-1, Appendix K.







¹⁾ Popular versions.

Note: If the device you require is not available as a complete unit, see "Modular system" on the next page.

3SE5, metal enclosures
Enclosure width 40 mm according to EN 50041

Modular system

2 or 3 contacts · Degree of protection IP66/IP67 · Cable entry M20 × 1.5

Version	Contacts	LEDs	DT	Modular system	PU (UNIT, SET, M)	PS*	PG	
				Order No.	Price per PU			
Basic switches • Enclosure width 40 mm								
	With M20 × 1.5 connecting thread							
	Slow-action contacts	1 NO + 1 NC --	⊕ B	3SE5 112-0BA00	1	1 unit	102	
	Snap-action contacts	1 NO + 1 NC --	⊕ A	3SE5 112-0CA00	1	1 unit	102	
	• Gold-plated contacts		⊕ B	3SE5 112-0CA00-1AC1	1	1 unit	102	
	Slow-action contacts	1 NO + 2 NC --	⊕ A	3SE5 112-0KA00	1	1 unit	102	
	Snap-action contacts	1 NO + 2 NC --	⊕ A	3SE5 112-0LA00	1	1 unit	102	
	Slow-action contacts with make-before-break	1 NO + 2 NC --	⊕ A	3SE5 112-0MA00	1	1 unit	102	
	Slow-action contacts	2 NO + 1 NC --	⊕ A	3SE5 112-0PA00	1	1 unit	102	
	With increased corrosion protection¹⁾							
	Slow-action contacts	1 NO + 1 NC --	⊕ B	3SE5 112-0BA00-1CA0	1	1 unit	102	
	Snap-action contacts	1 NO + 1 NC --	⊕ B	3SE5 112-0CA00-1CA0	1	1 unit	102	
	Slow-action contacts	1 NO + 2 NC --	⊕ B	3SE5 112-0KA00-1CA0	1	1 unit	102	
	Snap-action contacts	1 NO + 2 NC --	⊕ B	3SE5 112-0LA00-1CA0	1	1 unit	102	
	Slow-action contacts with make-before-break	1 NO + 2 NC --	⊕ B	3SE5 112-0MA00-1CA0	1	1 unit	102	
	Slow-action contacts	2 NO + 1 NC --	⊕ B	3SE5 112-0PA00-1CA0	1	1 unit	102	
	With M12 connector socket, 5-pole (125 V, 4 A)							
	Slow-action contacts	1 NO + 1 NC --	⊕ B	3SE5 114-0BA00-1AC5	1	1 unit	102	
	Snap-action contacts	1 NO + 1 NC --	⊕ B	3SE5 114-0CA00-1AC5	1	1 unit	102	
	Slow-action contacts	2 NC --	⊕ B	3SE5 114-0KA00-1AE1	1	1 unit	102	
	Snap-action contacts	2 NC --	⊕ B	3SE5 114-0LA00-1AE1	1	1 unit	102	
		With connector socket, 6-pole + PE (250 V, 10 A)						
Slow-action contacts		1 NO + 2 NC --	⊕ B	3SE5 115-0KA00-1AD1	1	1 unit	102	
Snap-action contacts		1 NO + 2 NC --	⊕ B	3SE5 115-0LA00-1AD1	1	1 unit	102	
With connector socket, 6-pole + PE (250 V, 10 A) and quick-release device								
Snap-action contacts		1 NO + 1 NC --	⊕ B	3SE5 115-0CA00-1AD0	1	1 unit	102	
		With 2 LEDs, yellow/green						
		Slow-action contacts	1 NO + 2 NC 24 V DC	⊕ B	3SE5 112-1KA00	1	1 unit	102
	Snap-action contacts	1 NO + 2 NC 24 V DC	⊕ B	3SE5 112-1LA00	1	1 unit	102	
	Slow-action contacts	1 NO + 2 NC 230 V AC	⊕ B	3SE5 112-3KA00	1	1 unit	102	
	Snap-action contacts	1 NO + 2 NC 230 V AC	⊕ B	3SE5 112-3LA00	1	1 unit	102	
		With M12 connector socket, 5-pole (125 V, 4 A) and 2 LEDs						
		Slow-action contacts	1 NO + 1 NC 24 V DC	⊕ B	3SE5 114-1BA00-1AF3	1	1 unit	102
Snap-action contacts		1 NO + 1 NC 24 V DC	⊕ B	3SE5 114-1CA00-1AF3	1	1 unit	102	
With M12 connector socket, 8-pole (30 V, 2 A) and 2 LEDs								
Snap-action contacts		1 NO + 2 NC 24 V DC	⊕ B	3SE5 114-1LA00-1AD4	1	1 unit	102	
		With connector socket, 6-pole + PE (10 A), and 2 LEDs						
		Slow-action contacts	1 NO + 1 NC 24 V DC	⊕ B	3SE5 115-1BA00-1AF2	1	1 unit	102
	Snap-action contacts	1 NO + 1 NC 24 V DC	⊕ B	3SE5 115-1CA00-1AF2	1	1 unit	102	
	Snap-action contacts	2 NC 24 V DC	⊕ B	3SE5 115-1LA00-1AD2	1	1 unit	102	







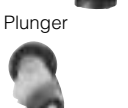

⊕ Positive opening according to IEC 60947-5-1, Appendix K, or positively driven actuator, necessary in safety circuits.

¹⁾ Use corresponding high-grade steel lever.

Note: For selection aid, see page 9/12.

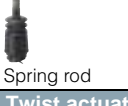
3SE5, 3SE2 Position Switches

3SE5, metal enclosures Enclosure width 40 mm according to EN 50041

Version	Diameter	DT	Modular system	PU (UNIT, SET, M)	PS*	PG	
	mm		Order No.	Price per PU			
Operating mechanisms							
	Plain plungers						
	High-grade steel plungers	10	⊕ A	3SE5 000-0AB01	1	1 unit	102
	Rounded plungers, type B acc. to EN 50041						
	High-grade steel plungers, with 3 mm overtravel	10	⊕ B	3SE5 000-0AC02	1	1 unit	102
	Roller plungers, type C acc. to EN 50041						
	High-grade steel roller, with 3 mm overtravel	13	⊕ B	3SE5 000-0AD02	1	1 unit	102
	Roller levers						
	Metal lever, plastic roller	22	⊕ A	3SE5 000-0AE01	1	1 unit	102
	Metal lever, high-grade steel roller	22	⊕ B	3SE5 000-0AE02	1	1 unit	102
	High-grade steel lever, plastic roller	22	⊕ B	3SE5 000-0AE03	1	1 unit	102
	Angular roller levers						
	Metal lever, plastic roller	22	⊕ A	3SE5 000-0AF01	1	1 unit	102
	Metal lever, high-grade steel roller	22	⊕ B	3SE5 000-0AF02	1	1 unit	102
	High-grade steel lever, plastic roller	22	⊕ B	3SE5 000-0AF03	1	1 unit	102
	Spring rods (for switches with snap-action contacts only)						
	Plastic plunger:						
	• Length 142.5 mm (spring 50 mm, plunger 50 mm)		B	3SE5 000-0AR01	1	1 unit	102
	• Length 76 mm (spring 23.5 mm, plunger 10 mm)		B	3SE5 000-0AR03	1	1 unit	102
High-grade steel plunger:							
• Length 242.5 mm (spring 150 mm, plunger 50 mm)		B	3SE5 000-0AR04	1	1 unit	102	
• Length 142.5 mm (spring 50 mm, plunger 50 mm)		B	3SE5 000-0AR02	1	1 unit	102	
Twist actuators							
	Twist actuators, metal (without lever)						
	• For twist levers and rod actuators, switching right and/or left, adjustable		⊕ A	3SE5 000-0AH00	1	1 unit	102
	Levers for twist actuators						
	• For fork levers, latching		⊕ B	3SE5 000-0AT10	1	1 unit	102
	Twist levers, offset, type A acc. to EN 50041						
	Metal lever 27 mm, plastic roller	19	⊕ A	3SE5 000-0AA01	1	1 unit	102
	Metal lever 27 mm, high-grade steel roller	19	⊕ A	3SE5 000-0AA02	1	1 unit	102
	Metal lever 27 mm, roller with ball bearing	19	⊕ B	3SE5 000-0AA03	1	1 unit	102
	Metal lever 27 mm, 2 plastic rollers	19	⊕ B	3SE5 000-0AA04	1	1 unit	102
	Metal lever 27 mm, plastic roller	30	⊕ B	3SE5 000-0AA05	1	1 unit	102
	Metal lever 27 mm, rubber roller	50	⊕ B	3SE5 000-0AA08	1	1 unit	102
	High-grade steel lever 27 mm, plastic roller	19	⊕ B	3SE5 000-0AA11	1	1 unit	102
	High-grade steel lever 27 mm, high-gr. steel roller	19	⊕ B	3SE5 000-0AA12	1	1 unit	102
	Metal lever 35 mm, plastic roller	19	⊕ B	3SE5 000-0AA15	1	1 unit	102
	Twist levers 30 mm, straight¹⁾						
	Metal lever, plastic roller	19	⊕ B	3SE5 000-0AA24	1	1 unit	102
	Twist levers, adjustable length, with grid hole						
	Metal lever, plastic roller	19	⊕ B	3SE5 000-0AA60	1	1 unit	102
	Metal lever, high-grade steel roller	19	⊕ B	3SE5 000-0AA61	1	1 unit	102
Metal lever, rubber roller	50	⊕ B	3SE5 000-0AA68	1	1 unit	102	
High-grade steel lever, plastic roller	19	⊕ B	3SE5 000-0AA62	1	1 unit	102	
High-grade steel lever, high-grade steel roller	19	⊕ B	3SE5 000-0AA63	1	1 unit	102	
Twist levers, adjustable length							
Metal lever, plastic roller	19	A	3SE5 000-0AA50	1	1 unit	102	
Metal lever, high-grade steel roller	19	B	3SE5 000-0AA51	1	1 unit	102	
Metal lever, plastic roller	30	B	3SE5 000-0AA55	1	1 unit	102	
Metal lever, rubber roller	50	B	3SE5 000-0AA58	1	1 unit	102	
High-grade steel lever, plastic roller	19	B	3SE5 000-0AA52	1	1 unit	102	
High-grade steel lever, high-grade steel roller	19	B	3SE5 000-0AA53	1	1 unit	102	
Fork levers (for switches with snap-action contacts only)							
2 metal levers, 2 plastic rollers	19	⊕ B	3SE5 000-0AT01	1	1 unit	102	
2 metal levers, 2 high-grade steel rollers	19	⊕ B	3SE5 000-0AT02	1	1 unit	102	
2 high-grade steel levers, 2 plastic rollers	19	⊕ B	3SE5 000-0AT03	1	1 unit	102	
Rod actuators, type D acc. to EN 50041							
Aluminum rod, length 200 mm	6	B	3SE5 000-0AA80	1	1 unit	102	
Spring rod, length 200 mm	6	B	3SE5 000-0AA81	1	1 unit	102	
Plastic rod, length 200 mm	6	B	3SE5 000-0AA82	1	1 unit	102	

⊕ Positively driven actuator, necessary in safety circuits.

¹⁾ Can be clinch mounted (turned through 180°, rear of lever).

Selection and ordering data

Complete units

2 or 3 contacts · Degree of protection IP66/IP67 · Cable entry 3 × (M20 × 1.5)

Version	Contacts	LEDs	DT	Complete units	PU (UNIT, SET, M)	PS*	PG
				Order No.	Price per PU		
Complete units¹⁾ · Enclosure width 56 mm							
Plain plungers							
	With high-grade steel plunger						
	Slow-action contacts	1 NO + 1 NC --	⊕ B	3SE5 122-0BB01	1	1 unit	102
	Snap-action contacts	1 NO + 1 NC --	⊕ B	3SE5 122-0CB01	1	1 unit	102
	Slow-action contacts	1 NO + 2 NC --	⊕ B	3SE5 122-0KB01	1	1 unit	102
	Snap-action contacts	1 NO + 2 NC --	⊕ B	3SE5 122-0LB01	1	1 unit	102
Plain plunger							
Rounded plungers							
	With high-grade steel plungers, with 3 mm overtravel						
	Slow-action contacts	1 NO + 1 NC --	⊕ B	3SE5 122-0BC02	1	1 unit	102
	Snap-action contacts	1 NO + 1 NC --	⊕ ▶	3SE5 122-0CC02	1	1 unit	102
	Slow-action contacts	1 NO + 2 NC --	⊕ B	3SE5 122-0KC02	1	1 unit	102
	Snap-action contacts	1 NO + 2 NC --	⊕ B	3SE5 122-0LC02	1	1 unit	102
Rounded plunger							
Roller plungers							
	With high-grade steel roller 13 mm, with 3 mm overtravel						
	Slow-action contacts	1 NO + 1 NC --	⊕ B	3SE5 122-0BD02	1	1 unit	102
	Snap-action contacts	1 NO + 1 NC --	⊕ A	3SE5 122-0CD02	1	1 unit	102
	Slow-action contacts	1 NO + 2 NC --	⊕ B	3SE5 122-0KD02	1	1 unit	102
	Snap-action contacts	1 NO + 2 NC --	⊕ B	3SE5 122-0LD02	1	1 unit	102
Roller plunger							
Roller levers							
	With metal lever and plastic roller 22 mm						
	Slow-action contacts	1 NO + 1 NC --	⊕ B	3SE5 122-0BE01	1	1 unit	102
	Snap-action contacts	1 NO + 1 NC --	⊕ A	3SE5 122-0CE01	1	1 unit	102
	Slow-action contacts	1 NO + 2 NC --	⊕ B	3SE5 122-0KE01	1	1 unit	102
	Snap-action contacts	1 NO + 2 NC --	⊕ B	3SE5 122-0LE01	1	1 unit	102
	With metal lever and high-grade steel roller 22 mm						
	Snap-action contacts	1 NO + 1 NC --	⊕ B	3SE5 122-0CE02	1	1 unit	102
Roller lever							
Angular roller levers							
	With metal lever and plastic roller 22 mm						
	Slow-action contacts	1 NO + 1 NC --	⊕ B	3SE5 122-0BF01	1	1 unit	102
	Snap-action contacts	1 NO + 1 NC --	⊕ B	3SE5 122-0CF01	1	1 unit	102
Angular roller lever							
Spring rods							
	Length 142.5 mm, with plastic plunger 50 mm						
	Snap-action contacts	1 NO + 1 NC --	B	3SE5 122-0CR01	1	1 unit	102
Spring rod							

⊕ Positive opening according to IEC 60947-5-1, Appendix K.

¹⁾ Popular versions.* You can order this quantity or a multiple thereof.
Illustrations are approximate





3SE5, 3SE2 Position Switches

3SE5, metal enclosures Enclosure width 56 mm

2 or 3 contacts · Degree of protection IP66/IP67 · Cable entry 3 × (M20 × 1.5)

Version	Contacts	LEDs	DT	Complete units	<input type="checkbox"/>	PU (UNIT, SET, M)	PS*	PG
				Order No.	Price per PU			

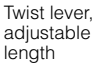
Complete units¹⁾ · Enclosure width 56 mm

	Twist levers							
	With metal lever 27 mm and plastic roller 19 mm							
	Slow-action contacts	1 NO + 1 NC --	⊕ B	3SE5 122-0BH01	1	1 unit	102	
	Snap-action contacts	1 NO + 1 NC --	⊕ A	3SE5 122-0CH01	1	1 unit	102	
	Slow-action contacts	1 NO + 2 NC --	⊕ B	3SE5 122-0KH01	1	1 unit	102	
	Snap-action contacts	1 NO + 2 NC --	⊕ B	3SE5 122-0LH01	1	1 unit	102	
	Twist levers, adjustable length							
	With metal lever with grid hole and plastic roller 19 mm							
	Slow-action contacts	1 NO + 1 NC --	⊕ B	3SE5 122-0BH60	1	1 unit	102	
	Snap-action contacts	1 NO + 1 NC --	⊕ A	3SE5 122-0CH60	1	1 unit	102	
	Snap-action contacts	1 NO + 2 NC --	⊕ B	3SE5 122-0LH60	1	1 unit	102	
	With metal lever and plastic roller 19 mm							
	Slow-action contacts	1 NO + 1 NC --	B	3SE5 122-0BH50	1	1 unit	102	
	Snap-action contacts	1 NO + 1 NC --	A	3SE5 122-0CH50	1	1 unit	102	
	Snap-action contacts	1 NO + 2 NC --	B	3SE5 122-0LH50	1	1 unit	102	
	Fork levers, latching							
	With metal lever and 2 plastic rollers 19 mm							
	Snap-action contacts	1 NO + 1 NC --	⊕ B	3SE5 122-0CT11	1	1 unit	102	
	Rod actuators							
	With aluminum rod, length 200 mm							
	Snap-action contacts	1 NO + 1 NC --	B	3SE5 122-0CH80	1	1 unit	102	
	With plastic rod, length 200 mm							
	Snap-action contacts	1 NO + 1 NC --	B	3SE5 122-0CH82	1	1 unit	102	



⊕ Positive opening according to IEC 60947-5-1, Appendix K.

¹⁾ Popular versions.

Note: If the device you require is not available as a complete unit, see "Modular system" on the next page.

Modular system





2 or 3 contacts · Degree of protection IP66/IP67 · Cable entry 3 × (M20 × 1.5)

Version	Contacts	LEDs	DT	Modular system	PU (UNIT, SET, M)	PS*	PG
				Order No.	Price per PU		
Basic switches · Enclosure width 56 mm							
With 3 x M20 x 1.5 connecting thread							
	Slow-action contacts	1 NO + 1 NC --	⊕ A	3SE5 122-0BA00	1	1 unit	102
	Snap-action contacts	1 NO + 1 NC --	⊕ A	3SE5 122-0CA00	1	1 unit	102
	Slow-action contacts	1 NO + 2 NC --	⊕ B	3SE5 122-0KA00	1	1 unit	102
	Snap-action contacts	1 NO + 2 NC --	⊕ A	3SE5 122-0LA00	1	1 unit	102
	Slow-action contacts with make-before-break	1 NO + 2 NC --	⊕ A	3SE5 122-0MA00	1	1 unit	102
	Slow-action contacts	2 NO + 1 NC --	⊕ A	3SE5 122-0PA00	1	1 unit	102
With increased corrosion protection¹⁾							
	Slow-action contacts	1 NO + 1 NC --	⊕ B	3SE5 122-0BA00-1CA00	1	1 unit	102
	Snap-action contacts	1 NO + 1 NC --	⊕ B	3SE5 122-0CA00-1CA00	1	1 unit	102
	Slow-action contacts	1 NO + 2 NC --	⊕ B	3SE5 122-0KA00-1CA00	1	1 unit	102
	Snap-action contacts	1 NO + 2 NC --	⊕ B	3SE5 122-0LA00-1CA00	1	1 unit	102
	Slow-action contacts with make-before-break	1 NO + 2 NC --	⊕ B	3SE5 122-0MA00-1CA00	1	1 unit	102
	Slow-action contacts	2 NO + 1 NC --	⊕ B	3SE5 122-0PA00-1CA00	1	1 unit	102
With 2 LEDs, yellow/green							
	Slow-action contacts	1 NO + 2 NC 24 V DC	⊕ B	3SE5 122-1KA00	1	1 unit	102
	Snap-action contacts	1 NO + 2 NC 24 V DC	⊕ B	3SE5 122-1LA00	1	1 unit	102
	Slow-action contacts	1 NO + 2 NC 230 V AC	⊕ B	3SE5 122-3KA00	1	1 unit	102
	Snap-action contacts	1 NO + 2 NC 230 V AC	⊕ B	3SE5 122-3LA00	1	1 unit	102

⊕ Positive opening according to IEC 60947-5-1, Appendix K, or positively driven actuator, necessary in safety circuits.

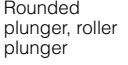
1) Use corresponding high-grade steel lever.

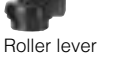
Note: For selection aid, see page 9/12.





Version	Diameter	DT	Modular system	PU (UNIT, SET, M)	PS*	PG
mm			Order No.	Price per PU		
Operating mechanisms						
Plain plungers						
	High-grade steel plungers	10	⊕ A	3SE5 000-0AB01	1	1 unit 102
	Rounded plungers, type B acc. to EN 50041					
	High-grade steel plungers, with 3 mm overtravel	10	⊕ B	3SE5 000-0AC02	1	1 unit 102
	Roller plungers, type C acc. to EN 50041					
	High-grade steel roller, with 3 mm overtravel	13	⊕ B	3SE5 000-0AD02	1	1 unit 102
	Roller levers					
	Metal lever, plastic roller	22	⊕ A	3SE5 000-0AE01	1	1 unit 102
	Metal lever, high-grade steel roller	22	⊕ B	3SE5 000-0AE02	1	1 unit 102
	High-grade steel lever, plastic roller	22	⊕ B	3SE5 000-0AE03	1	1 unit 102
	High-grade steel lever, high-grade steel roller	22	⊕ B	3SE5 000-0AE04	1	1 unit 102
Angular roller levers						
	Metal lever, plastic roller	22	⊕ A	3SE5 000-0AF01	1	1 unit 102
	Metal lever, high-grade steel roller	22	⊕ B	3SE5 000-0AF02	1	1 unit 102
	High-grade steel lever, plastic roller	22	⊕ B	3SE5 000-0AF03	1	1 unit 102
	High-grade steel lever, high-grade steel roller	22	⊕ B	3SE5 000-0AF04	1	1 unit 102
Spring rods (for switches with snap-action contacts only)						
	Plastic plunger:					
		• Length 142.5 mm (spring 50 mm, plunger 50 mm)	B	3SE5 000-0AR01	1	1 unit 102
		• Length 76 mm (spring 23.5 mm, plunger 10 mm)	B	3SE5 000-0AR03	1	1 unit 102
		• Length 242.5 mm (spring 150 mm, plunger 50 mm)	B	3SE5 000-0AR04	1	1 unit 102
	High-grade steel plunger:					
		• Length 142.5 mm (spring 50 mm, plunger 50 mm)	B	3SE5 000-0AR02	1	1 unit 102

⊕ Positively driven actuator, necessary in safety circuits.

* You can order this quantity or a multiple thereof.
Illustrations are approximate

3SE5, 3SE2 Position Switches

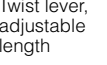
3SE5, metal enclosures Enclosure width 56 mm

Version	Diameter	DT	Modular system	PU (UNIT, SET, M)	PS*	PG	
	mm		Order No.	Price per PU			
Twist actuators							
	Twist actuators, metal (without lever)						
	<ul style="list-style-type: none"> For twist levers and rod actuators, switching right and/or left, adjustable For fork levers, latching 						
Twist actuator		⊕ A	3SE5 000-0AH00	1	1 unit	102	
		⊕ B	3SE5 000-0AT10	1	1 unit	102	
Levers for twist actuators							
	Twist levers 27 mm, offset, type A acc. to EN 50041						
	Metal lever, plastic roller	19	⊕ A	3SE5 000-0AA01	1	1 unit	102
	Metal lever, high-grade steel roller	19	⊕ A	3SE5 000-0AA02	1	1 unit	102
	Metal lever, roller with ball bearing	19	⊕ B	3SE5 000-0AA03	1	1 unit	102
	Metal lever, 2 plastic rollers	19	⊕ B	3SE5 000-0AA04	1	1 unit	102
	Metal lever, plastic roller	30	⊕ B	3SE5 000-0AA05	1	1 unit	102
	Metal lever, plastic roller	50	⊕ B	3SE5 000-0AA07	1	1 unit	102
	Metal lever, rubber roller	50	⊕ B	3SE5 000-0AA08	1	1 unit	102
	High-grade steel lever, plastic roller	19	⊕ B	3SE5 000-0AA11	1	1 unit	102
	High-grade steel lever, high-grade steel roller	19	⊕ B	3SE5 000-0AA12	1	1 unit	102
	Twist levers 35 mm, offset						
	Metal lever, plastic roller	19	⊕ B	3SE5 000-0AA15	1	1 unit	102
Twist levers 30 mm, straight¹⁾							
Metal lever, plastic roller	19	⊕ B	3SE5 000-0AA24	1	1 unit	102	
Metal lever, plastic roller	30	⊕ B	3SE5 000-0AA26	1	1 unit	102	
	Twist levers, adjustable length, with grid hole						
	Metal lever, plastic roller	19	⊕ B	3SE5 000-0AA60	1	1 unit	102
	Metal lever, high-grade steel roller	19	⊕ B	3SE5 000-0AA61	1	1 unit	102
	Metal lever, plastic roller	50	⊕ B	3SE5 000-0AA67	1	1 unit	102
	Metal lever, rubber roller	50	⊕ B	3SE5 000-0AA68	1	1 unit	102
	High-grade steel lever, plastic roller	19	⊕ B	3SE5 000-0AA62	1	1 unit	102
	Twist levers, adjustable length						
	Metal lever, plastic roller	19	A	3SE5 000-0AA50	1	1 unit	102
	Metal lever, high-grade steel roller	19	B	3SE5 000-0AA51	1	1 unit	102
	Metal lever, plastic roller	30	B	3SE5 000-0AA55	1	1 unit	102
	Metal lever, plastic roller	50	B	3SE5 000-0AA57	1	1 unit	102
	Metal lever, rubber roller	50	B	3SE5 000-0AA58	1	1 unit	102
	High-grade steel lever, plastic roller	19	B	3SE5 000-0AA52	1	1 unit	102
High-grade steel lever, high-grade steel roller	19	B	3SE5 000-0AA53	1	1 unit	102	
	Fork levers (for switches with snap-action contacts only)						
	2 metal levers, 2 plastic rollers	19	⊕ B	3SE5 000-0AT01	1	1 unit	102
	2 metal levers, 2 high-grade steel rollers	19	⊕ B	3SE5 000-0AT02	1	1 unit	102
	2 high-grade steel levers, 2 plastic rollers	19	⊕ B	3SE5 000-0AT03	1	1 unit	102
	2 high-grade steel levers, 2 high-grade steel rollers	19	⊕ B	3SE5 000-0AT04	1	1 unit	102
	Rod actuators, type D acc. to EN 50041						
	Aluminum rod, length 200 mm	6	B	3SE5 000-0AA80	1	1 unit	102
	Spring rod, length 200 mm	6	B	3SE5 000-0AA81	1	1 unit	102
	Plastic rod, length 200 mm	6	B	3SE5 000-0AA82	1	1 unit	102







⊕ Positively driven actuator, necessary in safety circuits.

¹⁾ Can be clinch mounted (turned through 180°, rear of lever).

Selection and ordering data

Complete units

4 or 5 contacts · Degree of protection IP66/IP67 · Cable entry 3 × (M20 × 1.5)

Version	Contacts	LEDs	DT	Complete units	PU (UNIT, SET, M)	PS*	PG
				Order No.	Price per PU		
Complete units¹⁾ · Enclosure width 56 mm, XL							
	Plain plungers With high-grade steel plunger						
Plain plunger	Snap-action contacts	2 × (1 NO + 1 NC) --	⊕ B	3SE5 162-0CB01	1	1 unit	102
	Rounded plungers With high-grade steel plungers, with 3 mm overtravel						
Rounded plunger	Slow-action contacts	1 NO + 1 NC and --	⊕ B	3SE5 162-0EC02	1	1 unit	102
	Slow-action contacts with make-before-break	1 NO + 2 NC					
	2 mm travel difference						
	Roller plungers With high-grade steel roller 13 mm, with 3 mm overtravel						
Roller plunger	Slow-action contacts	2 × (1 NO + 1 NC) --	⊕ B	3SE5 162-0BD02	1	1 unit	102
	Snap-action contacts	2 × (1 NO + 1 NC) --	⊕ A	3SE5 162-0CD02	1	1 unit	102
	Roller levers With metal lever and plastic roller 22 mm						
Roller lever	Slow-action contacts	2 × (1 NO + 1 NC) --	⊕ B	3SE5 162-0BE01	1	1 unit	102
	Snap-action contacts	2 × (1 NO + 1 NC) --	⊕ A	3SE5 162-0CE01	1	1 unit	102
	With metal lever and high-grade steel roller 22 mm						
	Snap-action contacts	2 × (1 NO + 1 NC) --	⊕ B	3SE5 162-0CE02	1	1 unit	102
	Angular roller levers With metal lever and plastic roller 22 mm						
Angular roller lever	Snap-action contacts	2 × (1 NO + 1 NC) --	⊕ B	3SE5 162-0CF01	1	1 unit	102
	Twist levers With metal lever 27 mm and plastic roller 19 mm						
Twist lever	Snap-action contacts	2 × (1 NO + 1 NC) --	⊕ A	3SE5 162-0CH01	1	1 unit	102

⊕ Positive opening according to IEC 60947-5-1, Appendix K.

¹⁾ Popular versions.*Note: If the device you require is not available as a complete unit, see "Modular system" on the next page.*

3SE5, 3SE2 Position Switches

Metal enclosures Enclosure width 56 mm, XL

Modular system

4 or 6 contacts · Degree of protection IP66/IP67 · Cable entry 3 × (M20 × 1.5)

Version	Contacts	LEDs	DT	Modular system	PU (UNIT, SET, M)	PS*	PG
				☒			
				Order No.	Price per PU		

Basic switches • Enclosure width 56 mm, XL



Basic switch

With 3 x M20 x 1.5 connecting thread

Slow-action contacts	2 × (1 NO + 1 NC) --	⊕ A	3SE5 162-0BA00	1	1 unit	102
Snap-action contacts	2 × (1 NO + 1 NC) --	⊕ A	3SE5 162-0CA00	1	1 unit	102
Slow-action contacts with make-before-break	2 × (1 NO + 2 NC) --	⊕ A	3SE5 162-0DA00	1	1 unit	102

With increased corrosion protection¹⁾

Slow-action contacts	2 × (1 NO + 1 NC) --	⊕ B	3SE5 162-0BA00-1CA0	1	1 unit	102
Snap-action contacts	2 × (1 NO + 1 NC) --	⊕ B	3SE5 162-0CA00-1CA0	1	1 unit	102
Slow-action contacts with make-before-break	2 × (1 NO + 2 NC) --	⊕ B	3SE5 162-0DA00-1CA0	1	1 unit	102

⊕ Positive opening according to IEC 60947-5-1, Appendix K, or positively driven actuator, necessary in safety circuits.

¹⁾ Use corresponding high-grade steel lever.

Note: For selection aid, see page 9/12.

Version	Diameter	DT	Modular system	PU (UNIT, SET, M)	PS*	PG
			☒			
		mm	Order No.	Price per PU		

Operating mechanisms



Plain plunger

Plain plungers

High-grade steel plungers	10	⊕ A	3SE5 000-0AB01	1	1 unit	102
---------------------------	----	-----	-----------------------	---	--------	-----



Rounded plunger

Rounded plungers, type B acc. to EN 50041

High-grade steel plungers, with 3 mm overtravel	10	⊕ B	3SE5 000-0AC02	1	1 unit	102
---	----	-----	-----------------------	---	--------	-----



Roller plunger

Roller plungers, type C acc. to EN 50041

High-grade steel roller, with 3 mm overtravel	13	⊕ B	3SE5 000-0AD02	1	1 unit	102
---	----	-----	-----------------------	---	--------	-----



Roller lever

Roller levers

Metal lever, plastic roller	22	⊕ A	3SE5 000-0AE01	1	1 unit	102
Metal lever, high-grade steel roller	22	⊕ B	3SE5 000-0AE02	1	1 unit	102
High-grade steel lever, plastic roller	22	⊕ B	3SE5 000-0AE03	1	1 unit	102
High-grade steel lever, high-grade steel roller	22	⊕ B	3SE5 000-0AE04	1	1 unit	102



Angular roller lever

Angular roller levers

Metal lever, plastic roller	22	⊕ A	3SE5 000-0AF01	1	1 unit	102
Metal lever, high-grade steel roller	22	⊕ B	3SE5 000-0AF02	1	1 unit	102
High-grade steel lever, plastic roller	22	⊕ B	3SE5 000-0AF03	1	1 unit	102
High-grade steel lever, high-grade steel roller	22	⊕ B	3SE5 000-0AF04	1	1 unit	102



Spring rod

Spring rods (for switches with snap-action contacts only)

Plastic plunger:





• Length 142.5 mm (spring 50 mm, plunger 50 mm)	B	3SE5 000-0AR01	1	1 unit	102
• Length 76 mm (spring 23.5 mm, plunger 10 mm)	B	3SE5 000-0AR03	1	1 unit	102
• Length 242.5 mm (spring 150 mm, plunger 50 mm)	B	3SE5 000-0AR04	1	1 unit	102

High-grade steel plunger:

• Length 142.5 mm (spring 50 mm, plunger 50 mm)	B	3SE5 000-0AR02	1	1 unit	102
---	---	-----------------------	---	--------	-----

⊕ Positively driven actuator, necessary in safety circuits.

Metal enclosures
Enclosure width 56 mm, XL

Version	Diameter	DT	Modular system	PU (UNIT, SET, M)	PS*	PG	
	mm		Order No.	Price per PU			
Twist actuators							
	Twist actuators , metal (without lever)						
	<ul style="list-style-type: none"> For twist levers and rod actuators, switching right and/or left, adjustable For fork levers, latching 						
Twist actuator		⊕ A	3SE5 000-0AH00	1	1 unit	102	
		⊕ B	3SE5 000-0AT10	1	1 unit	102	
Levers for twist actuators							
Twist levers 27 mm, offset, type A acc. to EN 50041							
	Metal lever, plastic roller	19	⊕ A	3SE5 000-0AA01	1	1 unit	102
	Metal lever, high-grade steel roller	19	⊕ A	3SE5 000-0AA02	1	1 unit	102
	Metal lever, roller with ball bearing	19	⊕ B	3SE5 000-0AA03	1	1 unit	102
	Metal lever, 2 plastic rollers	19	⊕ B	3SE5 000-0AA04	1	1 unit	102
	Metal lever, plastic roller	30	⊕ B	3SE5 000-0AA05	1	1 unit	102
	Metal lever, plastic roller	50	⊕ B	3SE5 000-0AA07	1	1 unit	102
	Metal lever, rubber roller	50	⊕ B	3SE5 000-0AA08	1	1 unit	102
	High-grade steel lever, plastic roller	19	⊕ B	3SE5 000-0AA11	1	1 unit	102
	High-grade steel lever, high-grade steel roller	19	⊕ B	3SE5 000-0AA12	1	1 unit	102
	Twist levers 35 mm, offset						
	Metal lever, plastic roller	19	⊕ B	3SE5 000-0AA15	1	1 unit	102
	Twist levers 30 mm, straight¹⁾						
Metal lever, plastic roller	19	⊕ B	3SE5 000-0AA24	1	1 unit	102	
Metal lever, plastic roller	30	⊕ B	3SE5 000-0AA26	1	1 unit	102	
Twist levers, adjustable length, with grid hole							
	Metal lever, plastic roller	19	⊕ B	3SE5 000-0AA60	1	1 unit	102
	Metal lever, high-grade steel roller	19	⊕ B	3SE5 000-0AA61	1	1 unit	102
	Metal lever, plastic roller	50	⊕ B	3SE5 000-0AA67	1	1 unit	102
	Metal lever, rubber roller	50	⊕ B	3SE5 000-0AA68	1	1 unit	102
	High-grade steel lever, plastic roller	19	⊕ B	3SE5 000-0AA62	1	1 unit	102
	High-grade steel lever, high-grade steel roller	19	⊕ B	3SE5 000-0AA63	1	1 unit	102
	Twist levers, adjustable length						
Twist lever, adjustable length	Metal lever, plastic roller	19	A	3SE5 000-0AA50	1	1 unit	102
	Metal lever, high-grade steel roller	19	B	3SE5 000-0AA51	1	1 unit	102
	Metal lever, plastic roller	30	B	3SE5 000-0AA55	1	1 unit	102
	Metal lever, plastic roller	50	B	3SE5 000-0AA57	1	1 unit	102
	Metal lever, rubber roller	50	B	3SE5 000-0AA58	1	1 unit	102
	High-grade steel lever, plastic roller	19	B	3SE5 000-0AA52	1	1 unit	102
	High-grade steel lever, high-grade steel roller	19	B	3SE5 000-0AA53	1	1 unit	102
Fork levers (for switches with snap-action contacts only)							
	2 metal levers, 2 plastic rollers	19	⊕ B	3SE5 000-0AT01	1	1 unit	102
	2 metal levers, 2 high-grade steel rollers	19	⊕ B	3SE5 000-0AT02	1	1 unit	102
	2 high-grade steel levers, 2 plastic rollers	19	⊕ B	3SE5 000-0AT03	1	1 unit	102
	2 high-grade steel levers, 2 high-grade steel rollers	19	⊕ B	3SE5 000-0AT04	1	1 unit	102
Rod actuators, type D acc. to EN 50041							
	Aluminum rod, length 200 mm	6	B	3SE5 000-0AA80	1	1 unit	102
	Spring rod, length 200 mm	6	B	3SE5 000-0AA81	1	1 unit	102
	Plastic rod, length 200 mm	6	B	3SE5 000-0AA82	1	1 unit	102
	Plastic rod, length 330 mm	6	B	3SE5 000-0AA83	1	1 unit	102

⊕ Positively driven actuator, necessary in safety circuits.

¹⁾ Can be clinch mounted (turned through 180°, rear of lever).

3SE5, 3SE2 Position Switches

3SE5, metal enclosures
Ambient temperature up to -40 °C

Selection and ordering data

Complete units

2 or 3 contacts · Degree of protection IP66/IP67 · Cable entry M20 × 1.5

Version	Contacts	LEDs	DT	Complete units	PU (UNIT, SET, M)	PS*	PG
				<input type="checkbox"/>			
				Order No.	Price per PU		

Complete units • Enclosure width 40 mm

Twist levers, adjustable length

With high-grade steel lever with grid hole
and plastic roller 19 mm



Twist lever,
adjustable
length

Snap-action contacts	1 NO + 1 NC --	⊕ A		3SE5 112-0CH62-1AJ0	1	1 unit	102
----------------------	----------------	-----	--	----------------------------	---	--------	-----

Modular system

2 or 3 contacts · Degree of protection IP66/IP67 · Cable entry M20 × 1.5

Version	Contacts	LEDs	DT	Modular system	PU (UNIT, SET, M)	PS*	PG
				<input checked="" type="checkbox"/>			
				Order No.	Price per PU		

Basic switches • Enclosure width 40 mm

With M20 × 1.5 connecting thread



Basic switch

Snap-action contacts	1 NO + 1 NC --	⊕ B		3SE5 112-0CA00-1AJ0	1	1 unit	102
Slow-action contacts	1 NO + 2 NC --	⊕ B		3SE5 112-0KA00-1AJ0	1	1 unit	102
Snap-action contacts	1 NO + 2 NC --	⊕ B		3SE5 112-0LA00-1AJ0	1	1 unit	102

Basic switches • Enclosure width 56 mm

With 3 x M20 x 1.5 connecting thread









Basic switch

Snap-action contacts	1 NO + 1 NC --	⊕ B		3SE5 122-0CA00-1AJ0	1	1 unit	102
Slow-action contacts	1 NO + 2 NC --	⊕ B		3SE5 122-0KA00-1AJ0	1	1 unit	102
Snap-action contacts	1 NO + 2 NC --	⊕ B		3SE5 122-0LA00-1AJ0	1	1 unit	102

⊕ Positive opening according to IEC 60947-5-1, Appendix K or positively driven actuator, necessary in safety circuits.

Note: For selection aid, see page 9/12.

3SE5, metal enclosures
Ambient temperature up to -40 °C

Version	Diameter	DT	Modular system	PU (UNIT, SET, M)	PS*	PG
	mm		Order No.	Price per PU		
Operating mechanisms						
	Rounded plungers, type B acc. to EN 50041 High-grade steel plungers, with 3 mm overtravel	10	⊕ B	3SE5 000-0AC02-1AJ0	1	1 unit 102
Rounded plunger						
	Roller plungers, type C acc. to EN 50041 High-grade steel roller, with 3 mm overtravel	10	⊕ B	3SE5 000-0AD02-1AJ0	1	1 unit 102
Roller plunger						
	Roller levers Metal lever, plastic roller	13	⊕ B	3SE5 000-0AE01-1AJ0	1	1 unit 102
Roller lever	High-grade steel lever, plastic roller	13	⊕ B	3SE5 000-0AE03-1AJ0	1	1 unit 102
	Angular roller levers Metal lever, plastic roller	13	⊕ B	3SE5 000-0AF01-1AJ0	1	1 unit 102
Angular roller lever	High-grade steel lever, plastic roller	13	⊕ B	3SE5 000-0AF03-1AJ0	1	1 unit 102
Twist actuators						
	Twist actuators, metal (without lever) Switching right and/or left, adjustable		⊕ B	3SE5 000-0AH00-1AJ0	1	1 unit 102
Twist actuator						
Levers for twist actuators						
	Twist levers, type A acc. to EN 50041 Metal lever, plastic roller	19	⊕ B	3SE5 000-0AA01-1AJ0	1	1 unit 102
Twist lever	High-grade steel lever, plastic roller	19	⊕ B	3SE5 000-0AA11-1AJ0	1	1 unit 102
	Twist levers, adjustable length, with grid hole Metal lever, plastic roller	19	⊕ B	3SE5 000-0AA60-1AJ0	1	1 unit 102
Twist lever, adjustable length	High-grade steel lever, plastic roller	19	⊕ B	3SE5 000-0AA62-1AJ0	1	1 unit 102

⊕ Positively driven actuator, necessary in safety circuits.

3SE5, 3SE2 Position Switches

3SE5, metal enclosures Compact design

Overview



Compact design in width 30 mm

Particularly in harsh environments or on equipment with limited space, the small 3SE5 4 position switches in compact design with a depth of 16 mm and a weight of only 80 g (without cable) are ideal. Above all the versions with molded cable can be mounted in the most confined places.

3SE5 4 compact position switches are available in two different widths as complete units:

- The 3SE5 413 series complies with the EU standard and features a 30 mm wide enclosure with drilled holes at a distance of 20 mm.
- The 3SE5 423 series meets the requirements of the US market and features a 40 mm wide enclosure with drilled holes at a spacing of 25 mm.

Both the enclosure and the twist actuator are made of metal and comply with the high IP67 degree of protection. Following actuators are available:

- Rounded plungers
- Rounded plungers with central fixing
- Rounded plungers with external seal
- Roller plungers
- Roller plunger with central fixing
- Twist levers

The contact block is designed with snap-action contacts 1 NO + 1 NC. The NC contact complies with the requirements for positive opening acc. to IEC 60947-5-1.

Use in safety circuits up to Category 4 according to EN ISO 13849-1.

Connection:

- With molded cable, 2 m or 5 m long
- With M12 connector socket

Benefits

- Very compact yet with the same rating as the 3SE51 standard switches, for notable space savings in confined installation conditions
- Various actuator versions available
- The actuators can be rotated in 90° increments
- Time is saved when mounting the fully assembled unit
- Ideal for use in harsh industrial environments thanks to metal enclosure with degrees of protection IP67
- Insensitive to electromagnetic interference

Selection and ordering data

2 snap-action contacts 1 NO + 1 NC · Degree of protection IP67 · With connecting cable or M12 connector socket

Operating mechanism	Enclosure width mm	DT	Order No.	Price per PU	PU (UNIT, SET, M)	PS*	PG	
Complete units • Enclosure width 30 or 40 mm								
 Rounded plunger	Rounded plungers							
	• Standard mounting							
	- With 2 m cable 5 x 0.75 mm ²	30	⊕ A	3SE5 413-0CC20-1EA2		1	1 unit	102
		40	⊕ A	3SE5 423-0CC20-1EA2		1	1 unit	102
	- With 5 m cable 5 x 0.75 mm ²	30	⊕ B	3SE5 413-0CC20-1EA5		1	1 unit	102
- With M12 connector socket	30	⊕ A	3SE5 413-0CC20-1EB1		1	1 unit	102	
	40	⊕ A	3SE5 423-0CC20-1EB1		1	1 unit	102	
 With central fixing	• With M12 central fixing							
	- With 2 m cable 5 x 0.75 mm ²	30	⊕ A	3SE5 413-0CC21-1EA2		1	1 unit	102
	40	⊕ A	3SE5 423-0CC21-1EA2		1	1 unit	102	
 With external seal	• With external seal							
	- With 2 m cable 5 x 0.75 mm ²	30	⊕ A	3SE5 413-0CC22-1EA2		1	1 unit	102
	40	⊕ A	3SE5 423-0CC22-1EA2		1	1 unit	102	
 Roller plunger	Roller plungers							
	• Standard mounting							
	- With 2 m cable 5 x 0.75 mm ²	30	⊕ A	3SE5 413-0CD20-1EA2		1	1 unit	102
		40	⊕ A	3SE5 423-0CD20-1EA2		1	1 unit	102
	- With 5 m cable 5 x 0.75 mm ²	30	⊕ B	3SE5 413-0CD20-1EA5		1	1 unit	102
- With M12 connector socket	30	⊕ A	3SE5 413-0CD20-1EB1		1	1 unit	102	
	40	⊕ A	3SE5 423-0CD20-1EB1		1	1 unit	102	
 With M12 central fixing	• With M12 central fixing							
	- With 2 m cable 5 x 0.75 mm ²	30	⊕ A	3SE5 413-0CD21-1EA2		1	1 unit	102
	40	⊕ A	3SE5 423-0CD21-1EA2		1	1 unit	102	
 With plug	• Actuator head rotated 90°							
	- With 2 m cable 5 x 0.75 mm ²	30	⊕ A	3SE5 413-0CD23-1EA2		1	1 unit	102
 Twist lever	Twist levers							
	• Standard mounting							
	- With 2 m cable 5 x 0.75 mm ²	30	⊕ A	3SE5 413-0CN20-1EA2		1	1 unit	102
		40	⊕ A	3SE5 423-0CN20-1EA2		1	1 unit	102
	- With 5 m cable 5 x 0.75 mm ²	30	⊕ A	3SE5 413-0CN20-1EA5		1	1 unit	102
- With M12 connector socket	30	⊕ A	3SE5 413-0CN20-1EB1		1	1 unit	102	
	40	⊕ A	3SE5 423-0CN20-1EB1		1	1 unit	102	

⊕ Positive opening according to IEC 60947-5-1, Appendix K.

3SE5, 3SE2 Position Switches

Open-Type

3SE5, open-type design

Overview



Open-type



Their compact design makes these switches particularly suitable for use in confined conditions. The fixing dimensions and operating points are according to EN 50047.

The switches are equipped with two or three contacts in slow-action or snap-action versions. The stroke is 6 mm.

The empty enclosure can be equipped with all switch block variants (see page 9/48).

Selection and ordering data

2 or 3 contacts · Degree of protection IP20 (2 contacts), IP10 (3 contacts)



















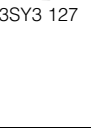
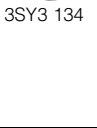

Version	Contacts	DT	Order No.	Price per PU	PU (UNIT, SET, M)	PS*	PG
Molded-plastic enclosures • Enclosure width 30 mm							
With teflon plunger, Ø 6 mm							
With contact block with 2 contacts							
	Slow-action contacts	1 NO + 1 NC	⊕ A	3SE5 250-0BC05	1	1 unit	102
	Snap-action contacts	1 NO + 1 NC	⊕ ▶	3SE5 250-0CC05	1	1 unit	102
With contact block with 3 contacts							
	Slow-action contacts	1 NO + 2 NC	⊕ B	3SE5 250-0KC05	1	1 unit	102
	Snap-action contacts	1 NO + 2 NC	⊕ A	3SE5 250-0LC05	1	1 unit	102
	Slow-action contacts with make-before-break	1 NO + 2 NC	⊕ A	3SE5 250-0MC05	1	1 unit	102
	Slow-action contacts	2 NO + 1 NC	⊕ A	3SE5 250-0PC05	1	1 unit	102
	Empty enclosures without contact block	--	⊕ B	3SE5 250-0AC05	1	1 unit	102

Empty enclosure

⊕ Positive opening according to IEC 60947-5-1, Appendix K.

Selection and ordering data





The quick-release devices and plug-in connections are used for fast installation and replacement of position switches.

Version	DT	Order No.	Price per PU	PU (UNIT, SET, M)	PS*	PG	
Quick-release devices for enclosure width 40 mm							
		Adapter plates with screws	B	3SY3 110	1	1 unit	102
		Base plates with locking lever	B	3SY3 027	1	1 unit	102
		3SY3 110					
		3SY3 027					
Plug-in connections for M20 x 1.5 connecting threads							
		Connector sockets (6-pole + PE), for M20 x 1.5 For max. 250 V, 10 A With 0.75 mm ² connecting cable, plastic, degree of protection IP65, ambient temperature -40 to +90 °C	C	3SY3 131	1	1 unit	102
		Cable boxes (6-pole + PE)¹⁾ With terminal compartment, can be pre-assembled, plastic, degree of protection IP65	A	3SY3 136	1	1 unit	102
		3SY3 131					
		3SY3 136					
		Connector sockets (4-pole), M12, for M20 x 1.5, fixed For max 250 V, 4 A, $U_{imp} = 2500$ V With four 0.25 mm ² connecting cables, plastic, degree of protection IP67, ambient temperature -40 to +85 °C	B	3SY3 127	1	1 unit	102
		Connector sockets (5-pole), M12, for M20 x 1.5, fixed For max. 125 V, 4 A, $U_{imp} = 1500$ V With five 0.25 mm ² connecting cables, plastic, degree of protection IP67, ambient temperature -40 to +85 °C	B	3SY3 128	1	1 unit	102
		3SY3 127					
		3SY3 128					
		Connector sockets (8-pole), M12, for M20 x 1.5, fixed, metal version For max. 30 V, 2 A, $U_{imp} = 800$ V With eight 0.25 mm ² connecting cables, metal, degree of protection IP67, ambient temperature -40 to +85 °C	C	3SY3 134	1	1 unit	102
		3SY3 134					
Adapters and cable glands for M20 x 1.5 connecting threads							
		Adapters according to  and  For cable entry from M20 x 1.5 to NPT 1/2	B	3SX9 917	1	1 unit	102
		• Metal • Plastic	D	3SX9 918	1	1 unit	102
		3SX9 917					
		3SX9 918					
		Cable glands M20 x 1.5 Plastic	A	3SX9 926	1	1 unit	102
		3SX9 926					

¹⁾ For wiring, a crimping tool is necessary, max. conductor cross-section 1 mm².

3SE5, 3SE2 Position Switches

Accessories and spare parts

Version	Color/ contacts	DT	Order No.	Price per PU	PU (UNIT, SET, M)	PS*	PG
Optional accessories for 3SE52							
	Protective caps, rubber, for rounded plungers acc. to EN 50047, 3SE5 ...-...C05	Black	A	3SE5 000-0AC30	1	1 unit	102
Spare parts for 3SE51, 3SE52							
	Empty enclosures, plastic Enclosure width 31 mm • With increased corrosion protection Enclosure width 50 mm • With increased corrosion protection	Turquoise	B	3SE5 232-0AC05	1	1 unit	102
			B	3SE5 232-0AC05-1CA0	1	1 unit	102
			B	3SE5 242-0AC05	1	1 unit	102
			B	3SE5 242-0AC05-1CA0	1	1 unit	102
Enclosure width 31 mm							
	Empty enclosures, metal Enclosure width 31 mm • With increased corrosion protection Enclosure width 40 mm • With increased corrosion protection Enclosure width 56 mm • With increased corrosion protection Enclosure width 56 mm, XL ¹⁾	Turquoise	B	3SE5 212-0AC05	1	1 unit	102
			B	3SE5 212-0AC05-1CA0	1	1 unit	102
			B	3SE5 112-0AA00	1	1 unit	102
			B	3SE5 112-0AA00-1CA0	1	1 unit	102
			B	3SE5 122-0AA00	1	1 unit	102
			B	3SE5 122-0AA00-1CA0	1	1 unit	102
Enclosure width 40 mm							
	Contact blocks with 2 contacts • Slow-action contacts • Snap-action contacts - Standard - Gold-plated contacts - 2 × 2 mm switching interval - Short stroke	1 NO + 1 NC 1 NO + 1 NC	⊕ B	3SE5 000-0BA00	1	1 unit	102
			⊕ B	3SE5 000-0CA00	1	1 unit	102
			⊕ B	3SE5 000-0CA00-1AC1	1	1 unit	102
			⊕ B	3SE5 000-0GA00	1	1 unit	102
			⊕ B	3SE5 000-0NA00	1	1 unit	102
2 contacts							
	Contact blocks with 3 contacts • Slow-action contacts • Snap-action contacts • Slow-action contacts with make-before-break • Slow-action contacts	1 NO + 2 NC 1 NO + 2 NC 1 NO + 2 NC 2 NO + 1 NC	⊕ B	3SE5 000-0KA00	1	1 unit	102
			⊕ B	3SE5 000-0LA00	1	1 unit	102
			⊕ A	3SE5 000-0MA00	1	1 unit	102
			A	3SE5 000-0PA00	1	1 unit	102
3 contacts							

⊕ Positive opening according to IEC 60947-5-1, Appendix K.

¹⁾ Equip XL enclosures only with contact combinations according to pages 9/11, 9/39 and 9/40.

Accessories and spare parts

Version	Rated voltage LED	DT	Order No.	Price per PU	PU (UNIT, SET, M)	PS*	PG
V							
Spare parts for 3SE51, 3SE52							
 31 mm, turquoise with LED	Covers for molded-plastic enclosures, width 31 mm						
	• Turquoise with LED	24 DC	B	3SE5 230-1AA00		1	1 unit 102
		230 AC	B	3SE5 230-3AA00		1	1 unit 102
	• Yellow	--	B	3SE5 230-0AA00-1AG0		1	1 unit 102
	• Yellow with LED	24 DC	B	3SE5 230-1AA00-1AG0		1	1 unit 102
		230 AC	B	3SE5 230-3AA00-1AG0		1	1 unit 102
 40 mm, yellow with LED	Covers for molded-plastic enclosures, width 40 mm						
	• Turquoise with LED	24 DC	B	3SE5 130-1AA00		1	1 unit 102
		230 AC	B	3SE5 130-3AA00		1	1 unit 102
	• Yellow	--	B	3SE5 130-0AA00-1AG0		1	1 unit 102
	• Yellow with LED	24 DC	B	3SE5 130-1AA00-1AG0		1	1 unit 102
		230 AC	B	3SE5 130-3AA00-1AG0		1	1 unit 102
 50 mm, turquoise with LED	Covers for molded-plastic enclosures, width 50 mm						
	• Turquoise with LED	24 DC	B	3SE5 240-1AA00		1	1 unit 102
		230 AC	B	3SE5 240-3AA00		1	1 unit 102
	• Yellow	--	B	3SE5 240-0AA00-1AG0		1	1 unit 102
	• Yellow with LED	24 DC	B	3SE5 240-1AA00-1AG0		1	1 unit 102
		230 AC	B	3SE5 240-3AA00-1AG0		1	1 unit 102
 31 mm, turquoise with LED	Covers for metal enclosures, width 31 mm						
	• Turquoise with LED	24 DC	B	3SE5 210-1AA00		1	1 unit 102
		230 AC	B	3SE5 210-3AA00		1	1 unit 102
	• Yellow	--	B	3SE5 210-0AA00-1AG0		1	1 unit 102
	• Yellow with LED	24 DC	B	3SE5 210-1AA00-1AG0		1	1 unit 102
		230 AC	B	3SE5 210-3AA00-1AG0		1	1 unit 102
 40 mm, yellow with LED	Covers for metal enclosures, width 40 mm						
	• Turquoise with LED	24 DC	B	3SE5 110-1AA00		1	1 unit 102
		230 AC	B	3SE5 110-3AA00		1	1 unit 102
	• Yellow	--	B	3SE5 110-0AA00-1AG0		1	1 unit 102
	• Yellow with LED	24 DC	B	3SE5 110-1AA00-1AG0		1	1 unit 102
		230 AC	B	3SE5 110-3AA00-1AG0		1	1 unit 102
 56 mm, yellow with LED	Covers for metal enclosures, width 56 mm						
	• Turquoise with LED	24 DC	B	3SE5 120-1AA00		1	1 unit 102
		230 AC	B	3SE5 120-3AA00		1	1 unit 102
	• Yellow	--	B	3SE5 120-0AA00-1AG0		1	1 unit 102
	• Yellow with LED	24 DC	B	3SE5 120-1AA00-1AG0		1	1 unit 102
		230 AC	B	3SE5 120-3AA00-1AG0		1	1 unit 102
Covers for XL metal enclosures, width 56 mm							
• Yellow	--	B	3SE5 160-0AA00-1AG0		1	1 unit 102	

3SE5, 3SE2 Position Switches With Separate Actuator

General data

Overview

Position switches with separate actuator are used where the position of doors, covers or protective grills must be monitored for safety reasons.

3SE5 position switches with separate actuator have the same enclosures as the standard switches (modular system).



Position switches with head for separate actuator

Design

Enclosure sizes

The 3SE5 switches are available in various enclosure sizes:

- Molded-plastic enclosures according to EN 50047, 31 mm wide, IP65, 1 cable entry
- Metal enclosures according to EN 50047, 31 mm wide, IP66/IP67, 1 cable entry
- Molded-plastic and metal enclosures according to EN 50041, 40 mm wide, IP66/IP67, 1 cable entry
- Molded-plastic enclosures, 50 mm wide, IP66/IP67, 2 cable entries
- Metal enclosures, 56 mm wide, IP66/IP67, 3 cable entries

Also available is a switch in the 3SE2 series which has arisen in this form according to general market requirements:

- Molded-plastic enclosures outside of the standards, enclosure width 52 mm, IP67

Enclosure versions

Various basic versions can be selected for the enclosures of the 3SE5 series:

- Available with two- or three-pole switching elements designed as slow-action contacts
- Optional LED status display
- With mounted four- or five-pole M12 connector socket (available for the wide enclosures as an accessory for self-assembly)
- With 6-pole connector socket + PE on the metal enclosures
- Similarly with a combination of connector socket and LED indicators
- Metal enclosures for explosion protection (ATEX) (see pages 9/77 and 9/81)
- AS-Interface version with integrated ASIsafe electronics for all enclosure designs (see page 9/90)

For a description of the basic switches see page 9/4.

Operation

The actuator head is included in the scope of supply. For actuation from four directions it can be adjusted through $4 \times 90^\circ$. The switches can also be approached from above.

The twist actuators of the 3SE2 243 and 3SE2 257 switches with special enclosures cannot be changed. The switches can be approached from the two broad sides and from above.

The actuators are not included in the scope of supply of the position switch and must be ordered separately from a choice of six versions to suit the application (see page 9/59).

The actuator is encoded. Simple overruling by hand or auxiliary devices is impossible.

Radius actuators

The position switches with radius actuators are particularly suitable for rotatable protective devices. The movable actuation key allows even small radii to be approached. Damage to the switch and the actuator due to inaccurate approach is prevented.

Locking devices

A high-grade steel blocking insert for attaching up to eight padlocks is available for even more safety (see page 9/59).



Blocking insert with padlock

Dust protection

A rubber cap to protect the twist actuator from contamination is available for operation in dusty environments (see page 9/59).

Contact reliability

The new switching blocks ensure an extremely high contact stability. This applies even when the devices are switching low voltages and currents, e.g. 1 mA at 5 V DC.

Positive opening

The NC contacts of the switch are forced open mechanically, positively-driven and reliably by the plunger. This is referred to as "positive opening".

3SE5, 3SE2 Position Switches

With Separate Actuator

General data

Benefits

The 3SE5 position switches with separate actuator differ from the previous series through the following new characteristics:

- All enclosure sizes with increased corrosion protection
- All enclosure sizes are optionally available with a LED signaling indicator.
- The three-pole contact block 1 NO + 2 NC is available for all enclosure sizes.
- The molded-plastic enclosure has simple and fast wiring equipment which makes it possible to save from approx. 20 to 25 % of the time when connecting.
- The ASIsafe electric component is integrated for the versions with the AS-Interface connection (see page 9/90); an adapter is not required.

Application

Position switches with separate actuator are used where the position of doors, covers or protective grills must be monitored for safety reasons.

The position switch can only be operated with the matching coded actuator. Simple overruling by hand or auxiliary devices is impossible.

Devices are available with enclosure versions to suit the particular ambient conditions. Different control tasks can be performed with the best contact blocks suited for the particular purpose. Dimensions, fixing points of the enclosure are in

accordance with EN 50041 or EN 50047 standards. The devices are suitable for use in any climate.

Standards

IEC 60947-5-1 or EN 60947-5-1.

The protective measure of "total insulation" by the molded-plastic enclosure is guaranteed by the use of molded-plastic screw-glands.

Safety position switches

For controls according to IEC 60204-1 or EN 60204-1 the devices can be used as a safety position switch. To secure position switches against changes in their position, keyed techniques must be employed on installation.

Safety circuits

IEC 60947-5-1 and EN 60947-5-1 require positive opening of the NC contacts, i.e. for the purposes of personal safety, the assured opening of NC contacts is expressly stipulated for the electrical equipment of machines in all safety circuits and marked according to the IEC standard 60947-5-1 with the symbol .

Category 3 according to ISO 13849-1 (EN 954-1) can be attained with a position switch with a separate actuator if the corresponding failsafe evaluation units are selected and correctly installed, e.g. the 3TK28 safety relays or matching units from the ASIsafe, SIMATIC or SINUMERIK product ranges.

Category 4 can be achieved when using an additional position switch.

Technical specifications

Type		3SE5 1...-V.., 3SE5 2...-V..	3SE2 257-.XX..	3SE2 243-.XX..			
General data							
Standards		IEC 60947-5-1, EN 60947-5-1					
Rated insulation voltage U_i	V	400	500				
Pollution degree acc. to EN 60664-1		Class 3	Class 3				
Rated impulse withstand voltage U_{imp}	kV	6	6				
Rated operational voltage U_e	V	400 AC; over 300 V AC only equal potential	500 AC; over 380 V AC only equal potential				
Conventional thermal current I_{th}	A	6	10				
Rated operational current I_e		2-pole	3-pole	1-pole	3-pole		
• With alternating current 50/60 Hz		$I_e/AC-15$	$I_e/AC-15$	$I_e/AC-12$	$I_e/AC-15$	$I_e/AC-12$	$I_e/AC-15$
- At 24 V	A	6	6	10	10	10	10
- At 120 V	A	6	3	10	10	10	10
- At 240 V	A	3	1.5	10	6	10	4
- At 400 V	A	--	--	10	4	10	4
- At 500 V	A	--	--	10	3	10	3
• For direct current		$I_e/DC-13$	$I_e/DC-13$	$I_e/DC-12$	$I_e/DC-13$	$I_e/DC-12$	$I_e/DC-13$
- At 24 V	A	3	3	10	10	10	10
- At 125 V	A	0.55	0.55	--	--	--	--
- At 250 V	A	0.27	0.27	--	--	--	--
- At 110 V	A	--	--	4	1	4	1
- At 220 V	A	--	--	1	0.4	1	0.4
- At 440 V	A	--	--	0.5	0.2	0.5	0.2
Short-circuit protection¹⁾							
• With DIAZED fuse links, operational class gG	A	6	6				
• With fuse links, quick		--	10				
• With miniature circuit breaker, Char. C	A	1	2	--			
Mechanical endurance		1 × 10 ⁶ operating cycles					
Electrical endurance		10 × 10 ⁶ operating cycles		> 1 × 10 ⁶ operating cycles			
• With 3RH.1, 3RT contactors in size S00, S0		0.1 × 10 ⁶ operating cycles		0.5 × 10 ⁶ operating cycles			
• For utilization category AC-15 when switching off $I_e/AC-15$ at 240 V							
Switching frequency		6000 operating cycles/h					
With 3RH.1, 3RT contactors in size S00, S0							
Minimum pull-out force for positive opening	N	20	10		30		

3SE5, 3SE2 Position Switches With Separate Actuator

General data

3SE51, 3SE52 configuration

Enclosure width 31 mm
3SE5 23.-.QV40, 3SE5 23.-.RV40

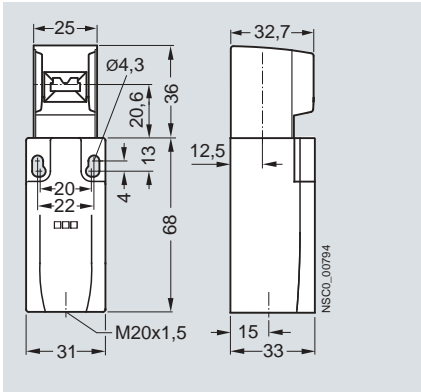

Enclosure width 50 mm
3SE5 24.-.QV40, 3SE5 24.-.RV40

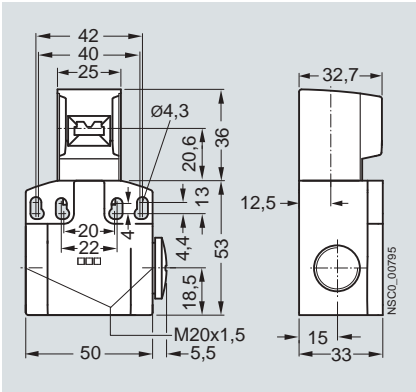

Enclosure width 40 mm
3SE5 11.-.QV10, 3SE5 11.-.RV10

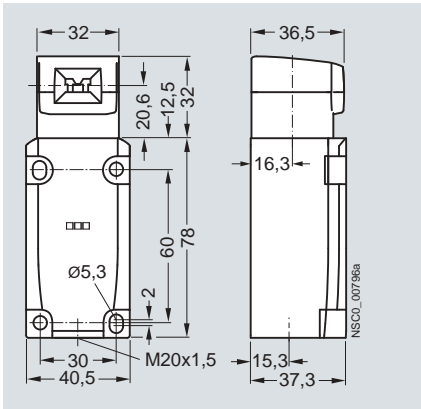

Enclosure width 56 mm
3SE5 12.-.QV10, 3SE5 12.-.RV10

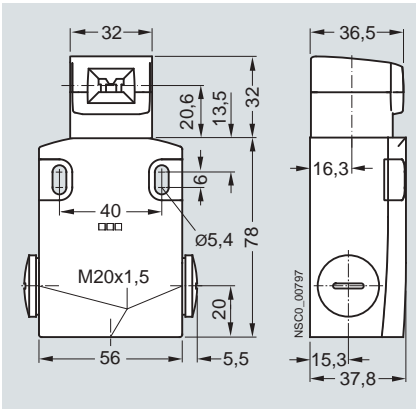

Actuators

3SE5 000-0AV01
standard actuator

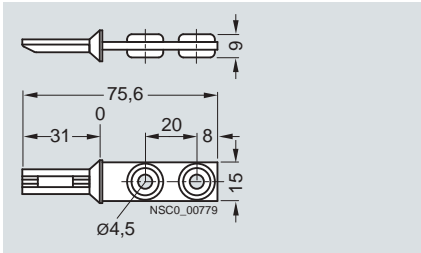

3SE5 000-0AV02
actuator with vertical fixing

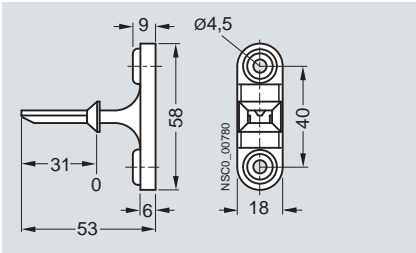

3SE5 000-0AV03
actuator with horizontal fixing

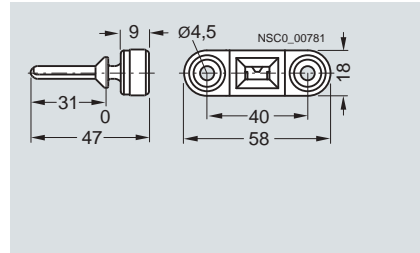

3SE5 000-0AV04
radius actuator, approach from left

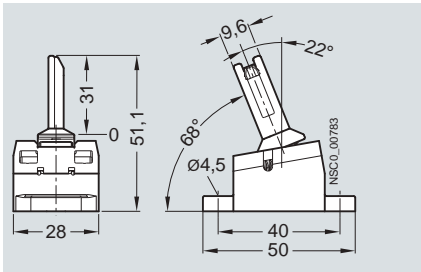

3SE5 000-0AV06
radius actuator approach from right

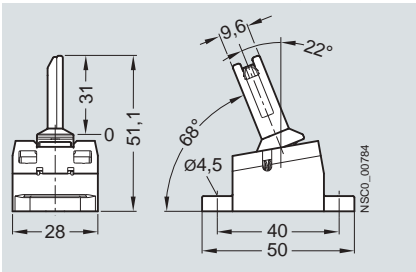

3SE5 000-0AV05
universal radius actuator

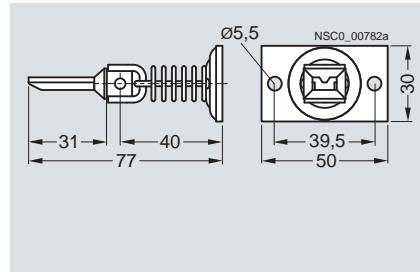

9

3SE5, 3SE2 Position Switches With Separate Actuator

General data

3SE5 000-0AV07 universal radius actuator, heavy duty

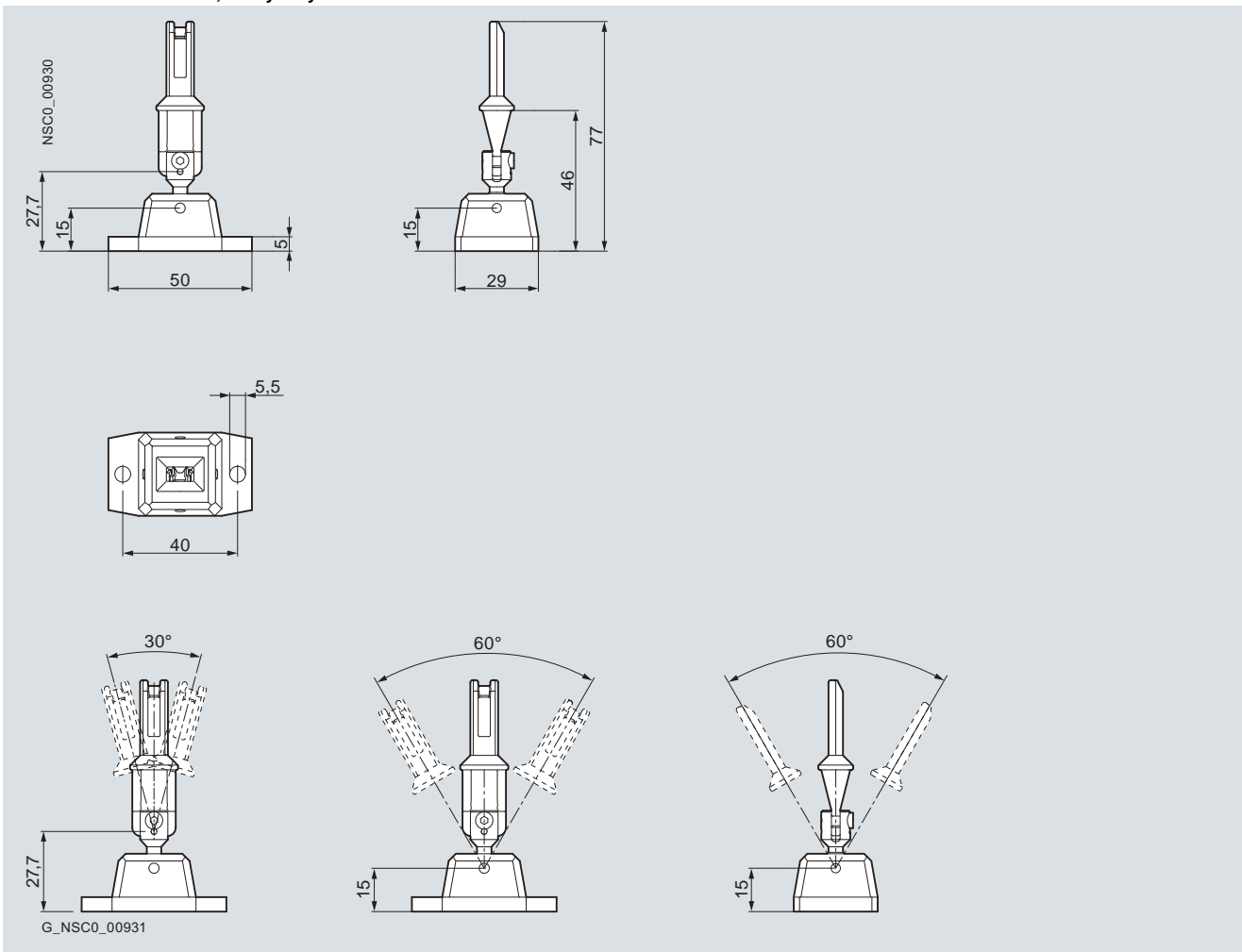

Actuation and operating travel

Standard actuators

Axial and lateral actuation ($4 \times 90^\circ$)

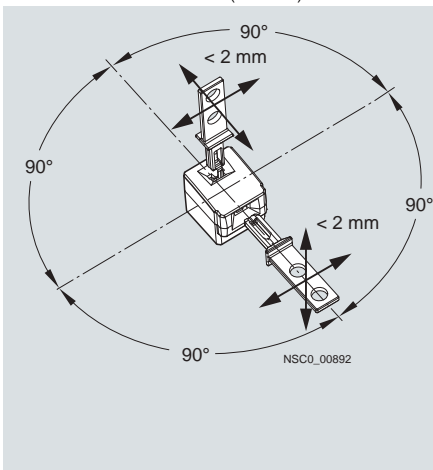

Lateral actuation ($4 \times 90^\circ$)

Slow-action contacts

1 NO + 1 NC, Ident. No. 11

mm 2,4** ≥ 30

1 NO + 2 NC, Ident. No. 12

mm 2,4** ≥ 30

Contact closed
 Contact open

Actuator in actuator head:
NC is closed

** Positive opening point

Radius actuators (all directions of approach)

Example: Direction of approach from the left

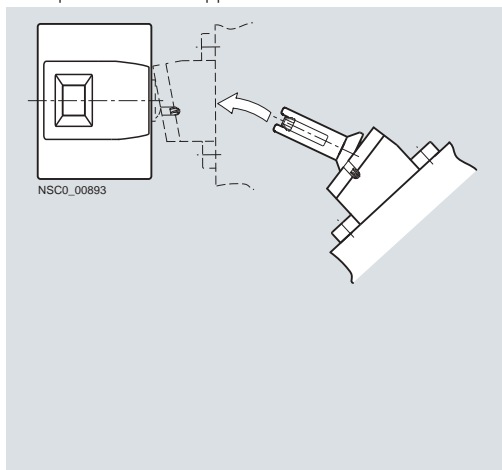

For circuit diagrams and connector assignment see page 9/11.

3SE5, 3SE2 Position Switches





With Separate Actuator

3SE5, molded-plastic enclosures
Enclosure width 31 mm acc. to EN 50047/50 mm

Selection and ordering data

Complete units

2 or 3 contacts · 5 directions of approach · Degree of protection IP65 (31 mm) or IP66/IP67 (50 mm) · Cable entry M20 × 1.5

Version ¹⁾	Contacts	LEDs	DT	Complete units	Price per PU	PU (UNIT, SET, M)	PS*	PG
Enclosure width 31 mm according to EN 50047								
	5 directions of approach							
	Slow-action contacts	1 NO + 1 NC --	⊕ B	3SE5 232-0RV40		1	1 unit	102
	Slow-action contacts	1 NO + 2 NC --	⊕ ▶ B	3SE5 232-0QV40		1	1 unit	102
	With increased minimum pull-out force 30 N							
	Slow-action contacts	1 NO + 2 NC --	⊕ B	3SE5 232-0QV40-1AA1		1	1 unit	102
	With M12 connector socket, 4-pole (250 V, 4 A)							
	Slow-action contacts	1 NO + 1 NC --	⊕ B	3SE5 234-0RV40-1AC4		1	1 unit	102
	Slow-action contacts	2 NC --	⊕ B	3SE5 234-0QV40-1AE0		1	1 unit	102
	With 2 LEDs, yellow/green							
	Slow-action contacts	1 NO + 1 NC 24 V DC	⊕ B	3SE5 232-1RV40		1	1 unit	102
	Slow-action contacts	1 NO + 1 NC 230 V AC	⊕ B	3SE5 232-3RV40		1	1 unit	102
	With M12 connector socket, 5-pole (125 V, 4 A) and 2 LEDs							
	Slow-action contacts	1 NO + 1 NC 24 V DC	⊕ B	3SE5 234-1RV40-1AF3		1	1 unit	102
Enclosure width 50 mm								
	5 directions of approach							
	Slow-action contacts	1 NO + 2 NC --	⊕ B	3SE5 242-0QV40		1	1 unit	102
	With increased minimum pull-out force 30 N							
	Slow-action contacts	1 NO + 1 NC --	⊕ B	3SE5 242-0RV40-1AA1		1	1 unit	102
	With 2 LEDs, yellow/green							
	Slow-action contacts	1 NO + 2 NC 24 V DC	⊕ B	3SE5 242-1QV40		1	1 unit	102
	Slow-action contacts	1 NO + 2 NC 230 V AC	⊕ B	3SE5 242-3QV40		1	1 unit	102

⊕ Positive opening according to IEC 60947-5-1, Appendix K.

¹⁾ Supplied without actuator. Please order separately (see page 9/59).

3SE5, 3SE2 Position Switches



With Separate Actuator

3SE5, molded-plastic enclosures
Enclosure width 40 mm according to EN 50041

Selection and ordering data

Complete units

2 or 3 contacts · 5 directions of approach · Degree of protection IP66/IP67 · Cable entry M20 × 1.5

Version ¹⁾	Contacts	LEDs	DT	Complete units	PU (UNIT, SET, M)	PS*	PG
				Order No.	Price per PU		
Enclosure width 40 mm according to EN 50041							
	5 directions of approach			3SE5 132-0QV20	1	1 unit	102
	Slow-action contacts	1 NO + 2 NC --	⊖ A				
	With 2 LEDs, yellow/green			3SE5 132-1QV20	1	1 unit	102
	Slow-action contacts	1 NO + 2 NC 24 V DC	⊕ B				
	Slow-action contacts	1 NO + 2 NC 230 V AC	⊕ C				
				3SE5 132-3QV20	1	1 unit	102

⊖ Positive opening according to IEC 60947-5-1, Appendix K.

¹⁾ Supplied without actuator. Please order separately (see page 9/59).

3SE5, 3SE2 Position Switches

With Separate Actuator

3SE5, metal enclosures
Enclosure width 31 mm according to EN 50047



Selection and ordering data

Complete units

2 or 3 contacts · 5 directions of approach · IP66/IP67 · Cable entry M20 × 1.5

Version ¹⁾	Contacts	LEDs	DT	Complete units	PU (UNIT, SET, M)	PS*	PG
				<input type="checkbox"/>			
				Order No.	Price per PU		

Enclosure width 31 mm according to EN 50047

		5 directions of approach							
	Slow-action contacts	1 NO + 1 NC	--	⊖ A	3SE5 212-0RV40	1	1 unit	102	
	Slow-action contacts	1 NO + 2 NC	--	⊖ B	3SE5 212-0QV40	1	1 unit	102	
		With 2 LEDs, yellow/green							
	Slow-action contacts	1 NO + 1 NC	24 V DC	⊖ B	3SE5 212-1RV40	1	1 unit	102	
	Slow-action contacts	1 NO + 1 NC	230 V AC	⊖ B	3SE5 212-3RV40	1	1 unit	102	

With 2 LEDs

⊖ Positive opening according to IEC 60947-5-1, Appendix K.

¹⁾ Supplied without actuator. Please order separately (see page 9/59).

3SE5, 3SE2 Position Switches







With Separate Actuator

3SE5, metal enclosures
Enclosure width 40 mm acc. to EN 50041/56 mm

Selection and ordering data

Complete units

2 or 3 contacts · 5 directions of approach · Degree of protection IP66/IP67 · Cable entry M20 × 1.5

Version ¹⁾	Contacts	LEDs	DT	Complete units	PU (UNIT, SET, M)	PS*	PG
				Order No.	Price per PU		
Enclosure width 40 mm according to EN 50041							
	5 directions of approach			⊕ ▶	3SE5 112-0QV10	1	1 unit 102
	Slow-action contacts	1 NO + 2 NC --					
With separate actuator	With increased minimum pull-out force 30 N			⊕ ▶	3SE5 112-0QV10-1AA7	1	1 unit 102
	Slow-action contacts	1 NO + 2 NC --					
	With M12 connector socket, 5-pole (125 V, 4 A)			⊕ B	3SE5 114-0RV10-1AC5	1	1 unit 102
	Slow-action contacts	1 NO + 1 NC --					
With M12 socket	With connector socket, 6-pole + PE (250 V, 10 A)			⊕ B	3SE5 114-0QV10-1AE1	1	1 unit 102
	Slow-action contacts	2 NC --					
	With 2 LEDs, yellow/green			⊕ B	3SE5 112-1QV10	1	1 unit 102
	Slow-action contacts	1 NO + 2 NC 24 V DC					
With 2 LEDs	With M12 connector socket, 5-pole and 2 LEDs			⊕ B	3SE5 112-3QV10	1	1 unit 102
	Slow-action contacts	1 NO + 2 NC 230 V AC					
	With connector socket, 6-pole + PE (10 A), and 2 LEDs			⊕ B	3SE5 114-1RV10-1AF3	1	1 unit 102
	Slow-action contacts	1 NO + 1 NC 24 V DC					
	With connector socket, 6-pole + PE (10 A), and 2 LEDs			⊕ B	3SE5 115-1RV10-1AF2	1	1 unit 102
	Slow-action contacts	1 NO + 1 NC 24 V DC					
Enclosure width 56 mm							
	5 directions of approach			⊕ B	3SE5 122-0QV10	1	1 unit 102
	Slow-action contacts	1 NO + 2 NC --					
With separate actuator	With increased minimum pull-out force 30 N			⊕ B	3SE5 122-0QV10-1AA7	1	1 unit 102
	Slow-action contacts	1 NO + 2 NC --					
	With 2 LEDs, yellow/green			⊕ B	3SE5 122-1QV10	1	1 unit 102
	Slow-action contacts	1 NO + 2 NC 24 V DC					
With 2 LEDs	With 2 LEDs, yellow/green			⊕ B	3SE5 122-3QV10	1	1 unit 102
	Slow-action contacts	1 NO + 2 NC 230 V AC					

⊕ Positive opening according to IEC 60947-5-1, Appendix K.











¹⁾ Supplied without actuator. Please order separately ([see page 9/59](#)).

3SE5, 3SE2 Position Switches

With Separate Actuator

Accessories

Selection and ordering data

Version	DT	Order No.	Price per PU	PU (UNIT, SET, M)	PS*	PG
Actuators for 3SE5						
 3SE5 000-0AV01		▶ 3SE5 000-0AV01		1	1 unit	102
Standard actuators						
• Length 75.6 mm						
 3SE5 000-0AV02	A	3SE5 000-0AV02		1	1 unit	102
• With vertical fixing, length 53 mm						
 3SE5 000-0AV03	A	3SE5 000-0AV03		1	1 unit	102
• With transverse fixing, length 47 mm						
 3SE5 000-0AV04	A	3SE5 000-0AV04		1	1 unit	102
Radius actuators, length 51 mm						
• Direction of approach from the left	A	3SE5 000-0AV06		1	1 unit	102
• Direction of approach from the right	A	3SE5 000-0AV06		1	1 unit	102
 3SE5 000-0AV05	A	3SE5 000-0AV05		1	1 unit	102
Universal radius actuators, length 77 mm						
 3SE5 000-0AV07	A	3SE5 000-0AV07-1AK2		1	1 unit	102
Universal radius actuators, heavy-duty						
• Length 67 mm	A	3SE5 000-0AV07		1	1 unit	102
• Length 77 mm	A	3SE5 000-0AV07		1	1 unit	102
Optional accessories for 3SE5						
 3SE5 000-0AV08-1AA2	B	3SE5 000-0AV08-1AA2		1	1 unit	102
Protective caps made of black rubber for the actuator head, to protect the actuator openings from contamination (Only for enclosure width 40 or 56 mm)						
 3SE5 000-0AV08-1AA3	C	3SE5 000-0AV08-1AA3		1	1 unit	102
Blocking inserts , high-grade steel, for actuator head, for up to 8 padlocks						
Connections for 3SE5, 3SE2						
 3SY3 127	B	3SY3 127		1	1 unit	102
Connector sockets (4-pole), M12, fixed for M20 x 1.5 For max. 250 V, 4 A With 0.25 mm ² connecting cable, plastic, degree of protection IP67, ambient temperature -40 to +85 °C						
 3SY3 128	B	3SY3 128		1	1 unit	102
Connector sockets (5-pole), M12, fixed for M20 x 1.5 For max. 125 V, 4 A With 0.25 mm ² connecting cable, plastic, degree of protection IP67, ambient temperature -40 to +85 °C						
 3SX9 926	A	3SX9 926		1	1 unit	102
Cable glands M20 x 1.5 Plastic						

3SE5, 3SE2 Position Switches

With Separate Actuator

3SE2, molded-plastic enclosures
Enclosure width 52 mm

Selection and ordering data

Complete units

1 or 3 contacts · 3 directions of approach · Degree of protection IP67

Version	Operation	DT	Complete units	□	PU (UNIT, SET, M)	PS*	PG	
			Order No.	Price per PU				
Molded-plastic enclosures in special width of 52 mm								
	Lateral and front-end actuation¹⁾	6 mm stroke						
	• With M20 × 1.5 connecting thread							
	- Slow-action contacts 1 NO + 2 NC	Holding force 5 N	⊙ ▶	3SE2 243-0XX40		1	1 unit	102
		Holding force 30 N	⊙ ▶	3SE2 243-0XX		1	1 unit	102
		With automatic ejection	⊙ ▶	3SE2 243-0XX30		1	1 unit	102
	- Slow-action contacts 1 NC	Holding force 5 N	⊙ ▶	3SE2 257-6XX40		1	1 unit	102
		Holding force 30 N	⊙ ▶	3SE2 257-6XX		1	1 unit	102
		With automatic ejection	⊙ B	3SE2 257-6XX30		1	1 unit	102
	• With M16 × 1.5 connecting thread							
	- Slow-action contacts 1 NO + 2 NC	Holding force 5 N	⊙ B	3SE2 243-0XX48		1	1 unit	102
		Holding force 30 N	⊙ A	3SE2 243-0XX18		1	1 unit	102
		With automatic ejection	⊙ C	3SE2 243-0XX38		1	1 unit	102
- Slow-action contacts 1 NC	Holding force 5 N	⊙ B	3SE2 257-6XX48		1	1 unit	102	
	Holding force 30 N	⊙ C	3SE2 257-6XX18		1	1 unit	102	
	With automatic ejection	⊙ ▶	3SE2 257-6XX38		1	1 unit	102	
Accessories								
	Actuators							
	• Standard actuators ($r_{\min} = 150$ mm), length 28 mm		A	3SX3 218		1	1 unit	102
		• Universal radius actuators ($r_{\min} = 45$ mm), length 34 mm		A	3SX3 228		1	1 unit
		• Radius actuators, adjustable radius, length 34 mm		D	3SX3 256		1	1 unit
		• Ball locating, force adjustable up to 100 N by 2 screws, length 28 mm		A	3SX3 217		1	1 unit
		• Actuators, length 34 mm, with dust protection and slit cover		D	3SX3 234		1	1 unit
		Accessories						
	• Slot covers (1 set = 3 units)		D	3SX3 233		1	3 units	102

⊙ Positive opening according to IEC 60947-5-1, Appendix K.

¹⁾ Supplied without actuator.

3SE5, 3SE2 Position Switches With Interlocking

General data

Overview

The position switches with interlocking are exceptional safety-related devices which prevent an unforeseen or intentional opening of protective doors, protective grills or other covers as long as a dangerous situation is present (i.e. follow-on motion of the switched off machine).



Position switches with interlocking

The safety position switches with interlocking are comprised of a switch part with electromechanical interlock and a mechanical actuator which has to be ordered separately.

They are rugged protective devices that enable the greatest possible safety for man and machine.

The position switches with interlocking are offered in plastic or metal enclosures.

Dimensions (W × H × D):

- 3SE5 3: 54 mm × 185 mm × 43.5 mm,
- 3SE2 8: 90 mm × 100 mm (+ head 41.3 mm) × 45 mm.

Operation

The actuator head is included in the scope of supply. For actuation from four directions it can be adjusted through $4 \times 90^\circ$. The 3SE5 3 switches can also be approached from above.

The actuators are not included in the scope of supply of the position switch and must be ordered separately from a choice of six versions to suit the application (see page 9/67).

Actuation data:

- Maximum actuating speed $v_{\max} = 1.5$ m/s
- Minimum actuating speed $v_{\min} = 0.4$ mm/s
- Minimum force in the direction of actuation $F_{\min} = 30$ N

The actuator is encoded. Simple overruling by hand or auxiliary devices is impossible.

Radius actuators

The position switches with radius actuators are particularly suitable for rotatable protective devices. The movable actuation key allows even small radii to be approached. Damage to the switch and the actuator due to inaccurate approach is prevented.

Locking devices

A high-grade steel locking device for attaching up to eight padlocks is available for even more safety (see page 9/67).

Dust protection

A rubber cap to protect the twist actuator from contamination is available for operation in dusty environments (see page 9/67).

Interlocking

There are two versions for locking the actuator:

- Spring-actuated lock (closed-circuit principle) with various release mechanisms
- Solenoid lock (open-circuit principle)

The spring-actuated switch is equipped with an auxiliary release for emergency situations or setup mode. Available as options:

- Escape release or
- Emergency release

Contact blocks

The position switches with interlocking have one switching block each for:

- Monitoring the actuator or the position of the protective door
- Monitoring the position of the solenoid

The mechanical design of the switch corresponds to the requirements of the failsafe principle according to EN 1088.

Optical signaling equipment

The position switches with interlocking are available with an optional optical signaling device.

The signaling device indicates the switch position of the lock and the protective device optically by means of 2 LEDs on the front.

Protective device	Solenoid interlocking	Display	Meaning
Closed	Released		Actuator to be pulled
Closed	Locked		Actuator locked
Open	Released		Actuator pulled

Note:

The voltage of the LEDs at the monitored contacts must be the same as the operational voltage of the solenoid (same potential).

3SE5, 3SE2 Position Switches With Interlocking

General data

Benefits

The new generation of 3SE5 3 position switches offers:

- More safety through higher locking forces:
 - 1300 N with molded-plastic enclosure
 - 2600 N with metal enclosure
- Various release mechanisms: lock release, escape release and emergency release
- Two contact blocks each with three contacts as standard equipment, hence fewer versions needed
- Same dimensions for all enclosure variants: Plastic, metal or with integrated ASIsafe
- An extensive range of actuators
- An optional LED status display 24 V DC, 115 V AC or 230 V AC for all switch versions
- Device with ASIsafe electronics integrated in the enclosure (see page 9/94).

Application

The position switches with interlocking are exceptional safety-related devices which prevent an unforeseen or intentional opening of protective doors, protective grills or other covers as long as a dangerous situation is present (i.e. follow-on motion of the switched off machine).

The safety position switches with interlocking have the following functions:

- Enabling the machine or process with closed and locked protective device
- Locking the machine or process with opened protective device
- Position monitoring of the protective device and interlocking

Standards

The switches comply with the standards IEC 60947-1 (Low-Voltage Switchgear and Controlgear, General) and IEC 60947-5-1 (Electromechanical Control Circuit Devices).

The mechanical design of the switch corresponds to the requirements of the failsafe principle according to EN 1088.

Approvals

The switches are approved for use with locking devices according to EN 1088 and EN 292, Parts 1 and 2.

3SE5 3 position switches with interlocking bear the VDE test mark for tested according to GS-ET19 (Test Principles of the German Trade Association for Locking Devices with Electromagnetic Interlocks).

3SE2 8 metal-enclosed position switches with interlocking have been awarded a test certificate from the BIA (Berufsgenossenschaftliches Institut für Arbeitssicherheit).

Category 3 according to ISO 13849-1 (EN 954-1) can be attained with a position switch with interlocking if the corresponding failsafe evaluation units are selected and correctly installed, e.g. the 3TK28 safety relays or matching units from the ASIsafe, SIMATIC or SINUMERIK product ranges.

Category 4 can be achieved when using an additional position switch.

These switches are approved according to UL 508, UL 50 and UL 746-C.

Interlocking

The separate actuator operates in a similar way to the coding of a key and protects against manipulation. It transmits the locking force to the protective device and helps to monitor its position.

There are two versions of locking:

Spring-actuated lock (closed-circuit principle)

- In the standard version, the position switch locks by means of spring force and releases by means of electromagnetic force. In the case of voltage failure, it reliably prevents the protective device from opening when machine parts are still moving.
- The switch is equipped with an auxiliary release for emergency situations or setup mode.
- An auxiliary release which can be secured with a lock to prevent misuse is available as a version.



Auxiliary release

Auxiliary release with lock

The new 3SE5 3 position switches are also available with an escape release or emergency release.

- Personnel working inside the hazard zone can use the escape release feature to manually release the interlocking without tools from the escape side (hazardous area side) so that they can exit the hazard area. An intentional act (in this case pulling the gray actuator) is required to release the locking mechanism and restore the normal operating state.
- The emergency release enables someone in an emergency situation to manually release the interlock without tools from the access side (outside the hazardous area). Releasing the lock and restoring the normal operating state must require effort which is comparable to repair activity, in this case disassembly of the red actuator and resetting the mechanical lock.



Escape release from the front

Emergency release from the back

Solenoid lock (open-circuit principle)

- The second version offers locking by means of electromagnetic force and release by means of spring force. This version has an advantage when it is necessary to quickly access the machine after a power failure occurs, or in the case of very short coasting times.

3SE5, 3SE2 Position Switches

With Interlocking

General data

Examples of door interlocking



X-Lock door interlocking from Axelent



Door interlocking from Brühl

For the addresses of the manufacturers see Chapter 13 "Appendix" --> "External Partners".

Technical specifications

Type		3SE5 322	3SE5 312	3SE2 83, 3SE2 84	
General data					
Standards		IEC 60947-5-1, EN 60947-5-1			
Rated insulation voltage U_i	V	250			
Pollution degree acc. to EN 60664-1		Class 3			
Rated impulse withstand voltage U_{imp}	kV	4		6	
Rated operational voltage U_e					
• DC	V	24		24	
• AC 50/60 Hz	V	230		110 ... 130	230
Conventional thermal current I_{th}	A	6		10	
Rated operational current I_e					
• With alternating current 50/60 Hz		I_e / AC-15 or B300		I_e / AC-12	I_e / AC-15
- At 24 V	A	6		10	4
- At 120 V	A	3		10	4
- At 230 V	A	1.5		10	4
• For direct current		I_e / DC-13 or Q300		I_e / DC-12	I_e / DC-13
- At 24 V	A	3		10	3
- At 125 V	A	0.55		--	--
- At 250 V	A	0.27		--	--
- At 60 V		--		5	1.5
- At 110 V		--		2.5	0.7
- At 220 V		--		1	0.3
Magnet					
• Locking force, max.	N	1300	2600	1820	
• Locking force according to GS-ET 19	N	1000	2000	1400	
• Power consumption at U_c	W	3.5		5.2	
Short-circuit protection¹⁾					
• With DIAZED fuse links, operational class gG	A	6		6	
• With fuse links, quick		--		10	
• With miniature circuit breaker, Char. C	A	0.5		--	
Mechanical endurance		1 × 10 ⁶ operating cycles		1 × 10 ⁶ operating cycles	
Electrical endurance					
• With 3RH.1, 3RT contactors in size S00, S0		1 × 10 ⁶ operating cycles		1 × 10 ⁶ operating cycles	
• For utilization category AC-15 with interrupting of I_e / AC-15 at 230 V		1 × 10 ⁵ operating cycles		0.5 × 10 ⁶ operating cycles	
• With utilization category DC-12/DC-13		For direct current depending on the loading of the switch			
Switching frequency		6000 operating cycles/h			
With 3RH.1, 3RT contactors in size S00, S0					
Shock resistance acc. to IEC 60068-2-27		30 g/11 ms		--	

3SE5, 3SE2 Position Switches With Interlocking

General data

3SE53 configuration

Spring-actuated lock, with auxiliary release
3SE5 322-.SD2., 3SE5 322-.SG2., 3SE5 322-.SJ2.,
3SE5 312-.SD1., 3SE5 312-.SG1., 3SE5 312-.SJ1.,

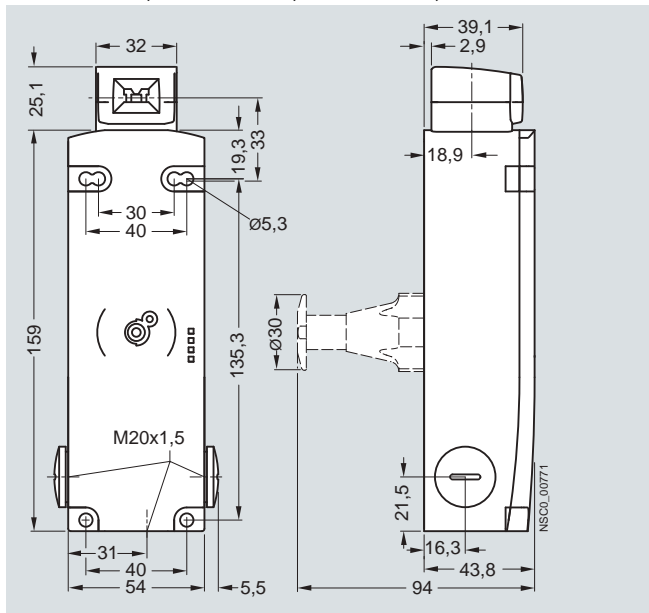

Spring-actuated lock, with auxiliary release with lock
3SE5 322-.SE2.,
3SE5 312-.SE1.

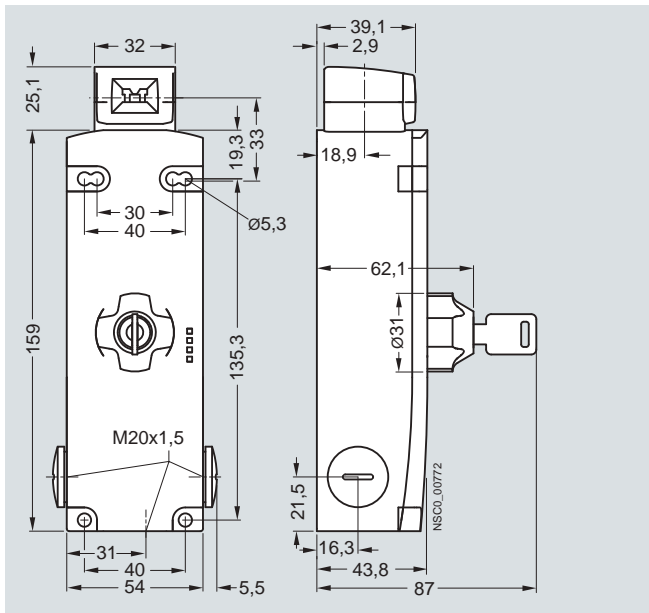

Spring-actuated lock, with escape release
3SE5 322-.SF2.,
3SE5 312-.SF1.

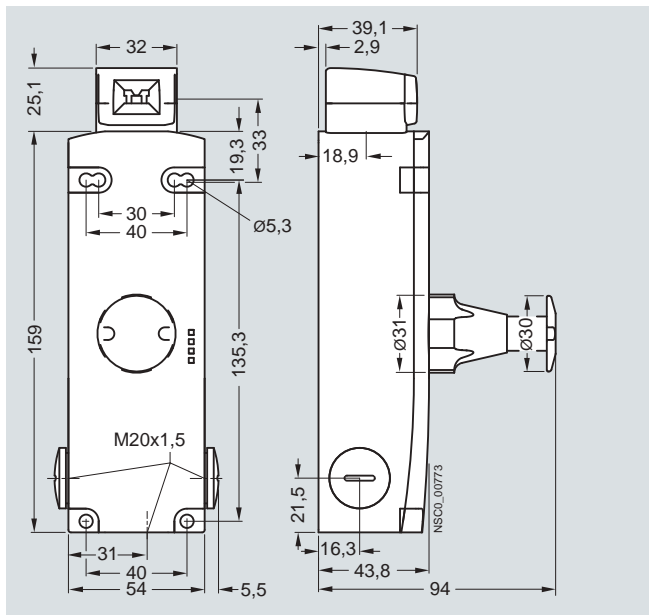

Solenoid lock
3SE5 322-.SB2.,
3SE5 312-.SB1.

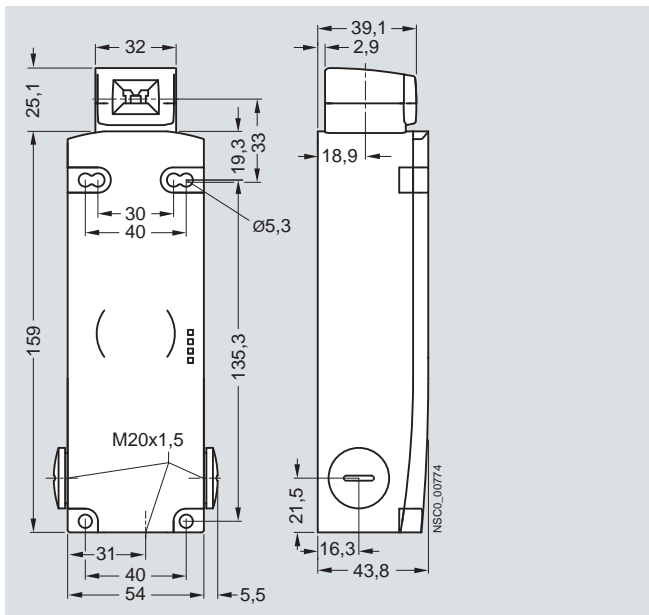

Note:
The molded-plastic enclosures have knock-out openings behind the connecting thread; they are delivered therefore without protective caps.

For actuators see page 9/52.
For actuation see page 9/53.

Circuit diagrams

Monitoring the actuator

Slow-action contacts 1 NO + 2 NC

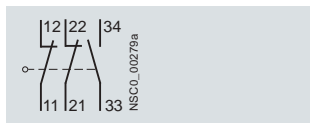

Monitoring the solenoid

Slow-action contacts 1 NO + 2 NC

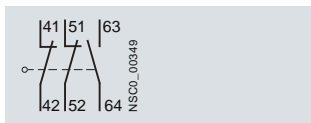

Operating travel

Monitoring the actuator

Slow-action contacts 1 NO + 2 NC

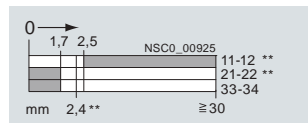

3SE5, 3SE2 Position Switches

With Interlocking

3SE5, molded-plastic enclosures
With locking force up to 1200 N

Selection and ordering data

6 slow-action contacts · 5 directions of approach · Degree of protection IP66/IP67 · Cable entry 3 × M20 × 1.5
Locking force 1300 N (1000 N according to GS-ET 19)

Interlock ¹⁾	LEDs	Solenoid, rated operational voltage	DT	Complete units Position monitoring: Actuators: 1 NO + 2 NC Solenoid: 1 NO + 2 NC	PU (UNIT, SET, M)	PS*	PG	
				Order No.	Price per PU			
1300 N locking force · Enclosure width 54 mm								
Spring-actuated locks								
	• With auxiliary release	--	24 DC	⊕ ▶	3SE5 322-0SD21	1	1 unit 102	
		--	115 AC	⊕ B	3SE5 322-0SD22	1	1 unit 102	
		--	230 AC	⊕ B	3SE5 322-0SD23	1	1 unit 102	
		Yellow/Green	24 DC	⊕ A	3SE5 322-1SD21	1	1 unit 102	
		Yellow/Green	115 AC	⊕ B	3SE5 322-2SD22	1	1 unit 102	
		Yellow/Green	230 AC	⊕ B	3SE5 322-3SD23	1	1 unit 102	
	• With auxiliary release With lock	--	24 DC	⊕ B	3SE5 322-0SE21	1	1 unit 102	
		--	115 AC	⊕ B	3SE5 322-0SE22	1	1 unit 102	
		--	230 AC	⊕ B	3SE5 322-0SE23	1	1 unit 102	
		Yellow/Green	24 DC	⊕ B	3SE5 322-1SE21	1	1 unit 102	
		Yellow/Green	115 AC	⊕ B	3SE5 322-2SE22	1	1 unit 102	
		Yellow/Green	230 AC	⊕ B	3SE5 322-3SE23	1	1 unit 102	
	• With escape release from the front	--	24 DC	⊕ B	3SE5 322-0SF21	1	1 unit 102	
		--	115 AC	⊕ B	3SE5 322-0SF22	1	1 unit 102	
		--	230 AC	⊕ B	3SE5 322-0SF23	1	1 unit 102	
		Yellow/Green	24 DC	⊕ B	3SE5 322-1SF21	1	1 unit 102	
		Yellow/Green	115 AC	⊕ B	3SE5 322-2SF22	1	1 unit 102	
		Yellow/Green	230 AC	⊕ B	3SE5 322-3SF23	1	1 unit 102	
	• With escape release from the front and emergency release from the back	--	24 DC	⊕ B	3SE5 322-0SL21	1	1 unit 102	
		• With escape release from the back and auxiliary release from the front	--	24 DC	⊕ B	3SE5 322-0SG21	1	1 unit 102
			--	115 AC	⊕ B	3SE5 322-0SG22	1	1 unit 102
			--	230 AC	⊕ B	3SE5 322-0SG23	1	1 unit 102
		Yellow/Green	24 DC	⊕ B	3SE5 322-1SG21	1	1 unit 102	
		Yellow/Green	115 AC	⊕ B	3SE5 322-2SG22	1	1 unit 102	
Yellow/Green	230 AC	⊕ B	3SE5 322-3SG23	1	1 unit 102			
	• With escape release from the back and auxiliary release with lock from the front	--	24 DC	⊕ B	3SE5 322-0SH21	1	1 unit 102	
		• With emergency release from the back and auxiliary release from the front	--	24 DC	⊕ B	3SE5 322-0SJ21	1	1 unit 102
			--	115 AC	⊕ B	3SE5 322-0SJ22	1	1 unit 102
			--	230 AC	⊕ B	3SE5 322-0SJ23	1	1 unit 102
		Yellow/Green	24 DC	⊕ B	3SE5 322-1SJ21	1	1 unit 102	
		Yellow/Green	115 AC	⊕ B	3SE5 322-2SJ22	1	1 unit 102	
Yellow/Green	230 AC	⊕ B	3SE5 322-3SJ23	1	1 unit 102			
	Solenoid locks	--	24 DC	⊕ ▶	3SE5 322-0SB21	1	1 unit 102	
		--	115 AC	⊕ B	3SE5 322-0SB22	1	1 unit 102	
		--	230 AC	⊕ B	3SE5 322-0SB23	1	1 unit 102	
		Yellow/Green	24 DC	⊕ A	3SE5 322-1SB21	1	1 unit 102	
		Yellow/Green	115 AC	⊕ B	3SE5 322-2SB22	1	1 unit 102	
		Yellow/Green	230 AC	⊕ B	3SE5 322-3SB23	1	1 unit 102	

⊕ Positive opening according to IEC 60947-5-1, Appendix K.

¹⁾ Supplied without actuator. Please order separately (see page 9/67).

* You can order this quantity or a multiple thereof.
Illustrations are approximate

3SE5, 3SE2 Position Switches

With Interlocking

3SE5, metal enclosures
With locking force up to 2000 N

Selection and ordering data

6 slow-action contacts · 5 directions of approach · Degree of protection IP66/IP67 · Cable entry 3 × M20 × 1.5
Locking force 2600 N (2000 N according to GS-ET 19)

Interlock ¹⁾	LEDs	Solenoid, rated operational voltage	DT	Complete units Position monitoring: Actuators: 1 NO + 2 NC Solenoid: 1 NO + 2 NC	PU (UNIT, SET, M)	PS*	PG	
				Order No.	Price per PU			
2600 N locking force · Enclosure width 54 mm								
Spring-actuated locks								
	• With auxiliary release	--	24 DC	⊕ ▶	3SE5 312-0SD11	1	1 unit	102
		--	115 AC	⊕ B	3SE5 312-0SD12	1	1 unit	102
		--	230 AC	⊕ B	3SE5 312-0SD13	1	1 unit	102
		Yellow/Green	24 DC	⊕ B	3SE5 312-1SD11	1	1 unit	102
		Yellow/Green	115 AC	⊕ B	3SE5 312-2SD12	1	1 unit	102
		Yellow/Green	230 AC	⊕ B	3SE5 312-3SD13	1	1 unit	102
	• With auxiliary release With lock	--	24 DC	⊕ B	3SE5 312-0SE11	1	1 unit	102
		--	115 AC	⊕ B	3SE5 312-0SE12	1	1 unit	102
		--	230 AC	⊕ B	3SE5 312-0SE13	1	1 unit	102
			48 AC/DC	⊕ C	3SE5 312-0SE14	1	1 unit	102
		Yellow/Green	24 DC	⊕ B	3SE5 312-1SE11	1	1 unit	102
		Yellow/Green	115 AC	⊕ B	3SE5 312-2SE12	1	1 unit	102
Yellow/Green	230 AC	⊕ B	3SE5 312-3SE13	1	1 unit	102		
	• With escape release from the front	--	24 DC	⊕ B	3SE5 312-0SF11	1	1 unit	102
		--	115 AC	⊕ B	3SE5 312-0SF12	1	1 unit	102
		--	230 AC	⊕ B	3SE5 312-0SF13	1	1 unit	102
		Yellow/Green	24 DC	⊕ B	3SE5 312-1SF11	1	1 unit	102
		Yellow/Green	115 AC	⊕ B	3SE5 312-2SF12	1	1 unit	102
		Yellow/Green	230 AC	⊕ B	3SE5 312-3SF13	1	1 unit	102
	• With escape release from the back and auxiliary release from the front	--	24 DC	⊕ B	3SE5 312-0SG11	1	1 unit	102
		--	115 AC	⊕ B	3SE5 312-0SG12	1	1 unit	102
		--	230 AC	⊕ B	3SE5 312-0SG13	1	1 unit	102
		Yellow/Green	24 DC	⊕ B	3SE5 312-1SG11	1	1 unit	102
		Yellow/Green	115 AC	⊕ B	3SE5 312-2SG12	1	1 unit	102
		Yellow/Green	230 AC	⊕ B	3SE5 312-3SG13	1	1 unit	102
	• With escape release from the back and auxiliary release from the front	--	24 DC	⊕ B	3SE5 312-0SH11	1	1 unit	102
		--	115 AC	⊕ B	3SE5 312-0SJ11	1	1 unit	102
		--	115 AC	⊕ B	3SE5 312-0SJ12	1	1 unit	102
		--	230 AC	⊕ B	3SE5 312-0SJ13	1	1 unit	102
		Yellow/Green	24 DC	⊕ B	3SE5 312-1SJ11	1	1 unit	102
		Yellow/Green	115 AC	⊕ B	3SE5 312-2SJ12	1	1 unit	102
Yellow/Green	230 AC	⊕ B	3SE5 312-3SJ13	1	1 unit	102		
	Solenoid locks	--	24 DC	⊕ ▶	3SE5 312-0SB11	1	1 unit	102
		--	115 AC	⊕ B	3SE5 312-0SB12	1	1 unit	102
		--	230 AC	⊕ B	3SE5 312-0SB13	1	1 unit	102
		Yellow/Green	24 DC	⊕ B	3SE5 312-1SB11	1	1 unit	102
		Yellow/Green	115 AC	⊕ B	3SE5 312-2SB12	1	1 unit	102
		Yellow/Green	230 AC	⊕ B	3SE5 312-3SB13	1	1 unit	102

⊕ Positive opening according to IEC 60947-5-1, Appendix K.











¹⁾ Supplied without actuator. Please order separately (see page 9/67).

3SE5, 3SE2 Position Switches

With Interlocking

Accessories

Selection and ordering data

Version	DT	Order No.	Price per PU	PU (UNIT, SET, M)	PS*	PG
Actuators for 3SE5						
 3SE5 000-0AV01		Standard actuators • Length 75.6 mm	▶	3SE5 000-0AV01	1	1 unit 102
 3SE5 000-0AV02	A	• With vertical fixing, length 53 mm		3SE5 000-0AV02	1	1 unit 102
 3SE5 000-0AV03	A	• With transverse fixing, length 47 mm		3SE5 000-0AV03	1	1 unit 102
 3SE5 000-0AV04	A	Radius actuators, length 51 mm • Direction of approach from the left		3SE5 000-0AV04	1	1 unit 102
	A	• Direction of approach from the right		3SE5 000-0AV06	1	1 unit 102
 3SE5 000-0AV05	A	Universal radius actuators, length 77 mm		3SE5 000-0AV05	1	1 unit 102
 3SE5 000-0AV07	A	Universal radius actuators, heavy-duty • Length 67 mm		3SE5 000-0AV07-1AK2	1	1 unit 102
	A	• Length 77 mm		3SE5 000-0AV07	1	1 unit 102
Optional accessories for 3SE5						
 3SE5 000-0AV08-1AA2	B	Protective caps made of black rubber for the actuator head, to protect the actuator openings from contamination		3SE5 000-0AV08-1AA2	1	1 unit 102
 3SE5 000-0AV08-1AA3	C	Blocking inserts , high-grade steel, for actuator head, for up to 8 padlocks		3SE5 000-0AV08-1AA3	1	1 unit 102
Spare parts for 3SE5						
	B	Spare keys		3SX5 100-1F	1	1 unit 102
Connections for 3SE5, 3SE2						
 3SY3 127	B	Connector sockets (4-pole), M12, fixed for M20 x 1.5 For max. 250 V, 4 A With 0,25 mm ² connecting cable, plastic, degree of protection IP67, ambient temperature -40 to +85 °C		3SY3 127	1	1 unit 102
	B	Connector sockets (5-pole), M12, fixed for M20 x 1.5 For max. 125 V, 4 A With 0,25 mm ² connecting cable, plastic, degree of protection IP67, ambient temperature -40 to +85 °C		3SY3 128	1	1 unit 102
 3SX9 926	A	Cable glands M20 x 1.5 Plastic		3SX9 926	1	1 unit 102

3SE5, 3SE2 Position Switches

Hinge Switches

General data

Overview

3SE5 hinge switches have the same enclosures as the standard switches (modular system).



Hinge switches

Design

Enclosure sizes

The 3SE5 switches are available as complete units in two enclosure sizes:

- Molded-plastic enclosures according to EN 50047, 31 mm wide, IP65, 1 cable entry
- Metal enclosures according to EN 50047, 31 mm wide, IP66/IP67, 1 cable entry
- Plastic and metal enclosures according to EN 50041, 40 mm wide, IP66/IP67, 1 cable entry

Enclosure versions

Various basic versions can be selected for the enclosures:

- Available with two or three-pole switching elements designed as snap-action contacts
- Metal enclosures for explosion protection (ATEX) (see pages 9/77 and 9/81)
- AS-Interface version with integrated ASIsafe electronics for all enclosure designs (see page 9/97)

For a description of the basic switches see page 9/4.

Operating mechanism

The hinge switches are provided for mounting on hinges. The actuator head is included in the scope of supply. There are two versions:

- Operating mechanism with hollow shaft, inner diameter 8 mm, outer 12 mm
- Operating mechanism with solid shaft, diameter 10 mm

Benefits

The 3SE5 hinge switches differ from the previous series through the following new characteristics:

- All actuators can be turned around the axis in increments of 22.5° (see picture on page 9/5).
- The new three-pole contact block 1 NO + 2 NC is available for all enclosure sizes (see picture on page 9/5).
- The molded-plastic enclosure with a width of 31 mm has simple and fast wiring equipment which makes it possible to save from approx. 20 to 25 % of the time when connecting (see picture on page 9/5).
- The ASIsafe electric component is integrated for the versions with the AS-Interface connection (see page 9/82); an additional adapter is not required.

Application

The hinge switches are used in those areas where the position of swivelable protective devices such as doors or flaps must be monitored. The position of the doors and hinge switches is converted into electric signals with the switches. The switches allow shutdown and signaling without delay in the event of a small opening angle through the snap-action contacts with an operating angle of 10°.

Devices are available with enclosure versions to suit the particular ambient conditions. Different control tasks can be performed with the best contact blocks suited for the particular purpose. Dimensions and fixing points of the enclosures are in accordance with EN 50041 or EN 50047 standards.

The devices are suitable for use in any climate.

Standards

IEC 60947-5-1 or EN 60947-5-1.

The protective measure of "total insulation" by the molded-plastic enclosure is guaranteed by the use of molded-plastic screw-glands.

Safety position switches

For controls according to IEC 60204-1 or EN 60204-1 the devices can be used as a safety position switch. To secure position switches against changes in their position, keyed techniques must be employed on installation.

Safety circuits

IEC 60947-5-1 and EN 60947-5-1 require positive opening of the NC contacts, i.e. for the purposes of personal safety, the assured opening of NC contacts is expressly stipulated for the electrical equipment of machines in all safety circuits and marked according to IEC 60947-5-1 with the symbol ☞.

Category 4 according to EN 954-1 can be attained with the 3SE5 hinge switches with ☞ if the corresponding failsafe evaluation units are selected and correctly installed, e.g. the 3TK28 safety relays or matching devices from the ASIsafe, SIMATIC or SINUMERIK product ranges.

3SE5, 3SE2 Position Switches Hinge Switches

General data

Technical specifications

The technical specifications are the same as for the standard switches (see page 9/7).

Configuration

Enclosure width 31 mm

With hollow shaft

3SE5 212-0.U21, 3SE5 232-0.U21

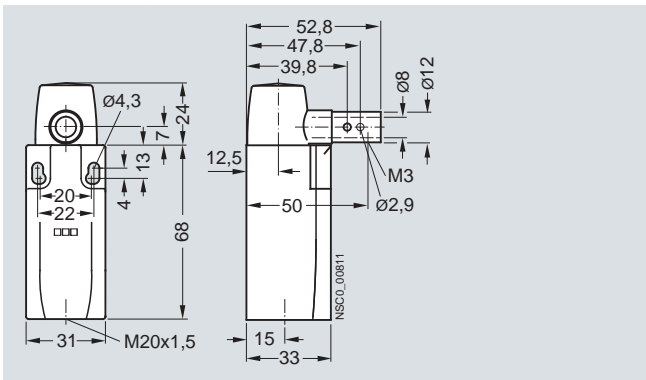

With solid shaft

3SE5 212-0.U22, 3SE5 232-0.U22

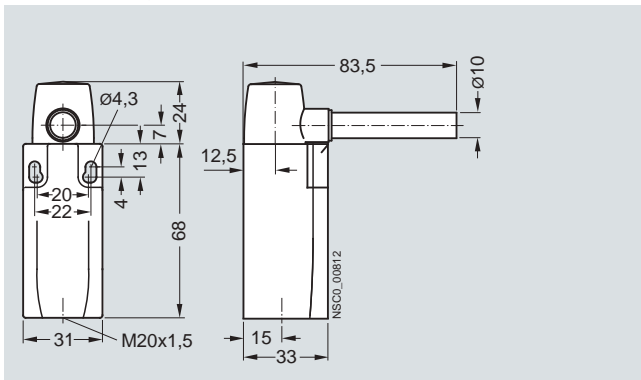

Enclosure width 40 mm

With hollow shaft

3SE5 112-0.U21, 3SE5 132-0.U21

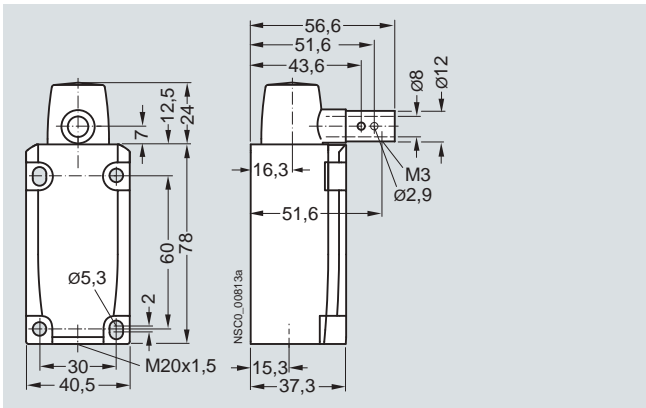

With solid shaft

3SE5 112-0.U22, 3SE5 132-0.U22

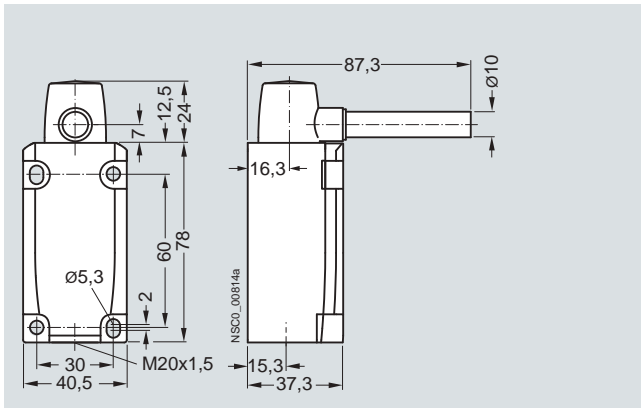

Operating travel of the shaft

Snap-action contacts

1 NO + 1 NC, Ident. No. 11

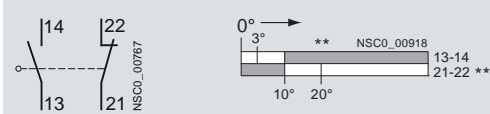

1 NO + 2 NC, Ident. No. 12

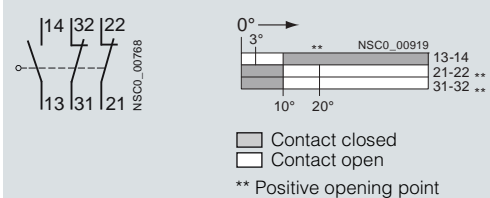

3SE5, 3SE2 Position Switches

Hinge Switches

3SE5, molded-plastic enclosures
Enclosure width 31 mm / 40 mm



Selection and ordering data

Complete units

2 or 3 contacts · Degree of protection IP65 (31 mm) or IP67/IP68 (40 mm) · Cable entry M20 × 1.5

Version	Snap-action contacts	DT	Complete units	PU (UNIT, SET, M)	PS*	PG
			<input type="checkbox"/>			
			Order No.	Price per PU		



Plastic enclosures · Enclosure width 31 mm according to EN 50047

	With hollow shaft						
	Operating angle 10°	1 NO + 1 NC	⊕ B	3SE5 232-0HU21	1	1 unit	102
	Operating angle 10°	1 NO + 2 NC	⊕ B	3SE5 232-0LU21	1	1 unit	102
	With solid shaft						
	Operating angle 10°	1 NO + 1 NC	⊕ B	3SE5 232-0HU22	1	1 unit	102
	Operating angle 10°	1 NO + 2 NC	⊕ B	3SE5 232-0LU22	1	1 unit	102

With hollow shaft

With solid shaft

Plastic enclosures · Enclosure width 40 mm according to EN 50041

	With hollow shaft					
	Operating angle 10°	1 NO + 2 NC	⊕ B	3SE5 132-0LU21	1	1 unit
	With solid shaft					
	Operating angle 10°	1 NO + 2 NC	⊕ B	3SE5 132-0LU22	1	1 unit

With hollow shaft



With solid shaft

⊕ Positive opening according to IEC 60947-5-1, Appendix K.

Accessories/spare parts

Version	DT	Order No.	Price per PU	PU (UNIT, SET, M)	PS*	PG
---------	----	-----------	--------------	-------------------	-----	----

Actuator heads

	With hollow shaft					
	Operating angle 10°		B	3SE5 000-0AU21	1	1 unit
	With solid shaft					
	Operating angle 10°		B	3SE5 000-0AU22	1	1 unit

With hollow shaft

With solid shaft

Note:

The respective actuators are included in the scope of supply for the complete units.

3SE5, 3SE2 Position Switches

Hinge Switches

3SE5, metal enclosures
Enclosure width 31 mm / 40 mm



Selection and ordering data

Complete units



3 contacts · Degree of protection IP66/IP67 · Cable entry M20 × 1.5

Version	Snap-action contacts	DT	Complete units	Price per PU	PU (UNIT, SET, M)	PS*	PG
			<input type="checkbox"/>				
			Order No.	Price per PU			

Metal enclosures • Enclosure width 31 mm according to EN 50047

	With hollow shaft	1 NO + 2 NC	⊕ B	3SE5 212-0LU21	1	1 unit	102
	Operating angle 10°						
With hollow shaft							
	With solid shaft	1 NO + 2 NC	⊕ B	3SE5 212-0LU22	1	1 unit	102
	Operating angle 10°						
With solid shaft							

Metal enclosures • Enclosure width 40 mm according to EN 50041



	With hollow shaft	1 NO + 2 NC	⊕ B	3SE5 112-0LU21	1	1 unit	102
	Operating angle 10°						
With hollow shaft							
	With solid shaft	1 NO + 2 NC	⊕ B	3SE5 112-0LU22	1	1 unit	102
	Operating angle 10°						
With solid shaft							

⊕ Positive opening according to IEC 60947-5-1, Appendix K.

Accessories/spare parts

Version	DT	Order No.	Price per PU	PU (UNIT, SET, M)	PS*	PG
---------	----	-----------	--------------	-------------------	-----	----

Actuator heads

	With hollow shaft		B	3SE5 000-0AU21	1	1 unit	102
	Operating angle 10°						
With hollow shaft							
	With solid shaft		B	3SE5 000-0AU22	1	1 unit	102
	Operating angle 10°						
With solid shaft							

Note:
The respective actuators are included in the scope of supply for the complete units.

* You can order this quantity or a multiple thereof.
Illustrations are approximate

3SE5, 3SE2 Position Switches

Hinge Switches

3SE2, molded-plastic enclosures With integrated hinge

Overview

The 3SE2 283 hinge switches are particularly suitable for use in doors and flaps of machines that must be closed to ensure the safety of operating personnel. Their thin profile and compact design allow them to be directly mounted on a hinged protective cover and the stable frame.

Benefits

- Easy mounting through use of versions with integrated hinge
- Versions with small operating angle of 4°
- Protection against personal injury provided by positively driven NC contacts according to IEC 60947-5-1
- Simultaneous shutdown and reporting by 1 NO + 2 NC contacts

Technical specifications

Type	3SE2 283	
Rated insulation voltage U_i	V	250
Conventional thermal current I_{th}	A	2.5
Rated operational current I_e		
• At AC-15, 120 V	A	4.2
• At AC-15, 250 V	A	2
• At DC-13, 24 V	A	1
Min. make-break capacity	> 5 V / 1 mA	
Short-circuit protection		
• Operational class gG	A	2
Mechanical endurance	> 1 × 10 ⁶ operating cycles	
Switching frequency	1200 operating cycles/hour	
Positive opening	2 mm after opening point	
Enclosure material	Plastic	
Degree of protection	IP65	
Ambient temperature	°C	-25 ... +65
Shock resistance	30 g/18 ms	
Resistance to vibrations	20 g/10 ... 200 Hz	
Cable entry	2 × (M20 × 1.5)	
Screw terminals	0.5 ... 1.5 mm ² /AWG 15	

Configuration

3SE2 283-GA.3 hinge switch with hinge

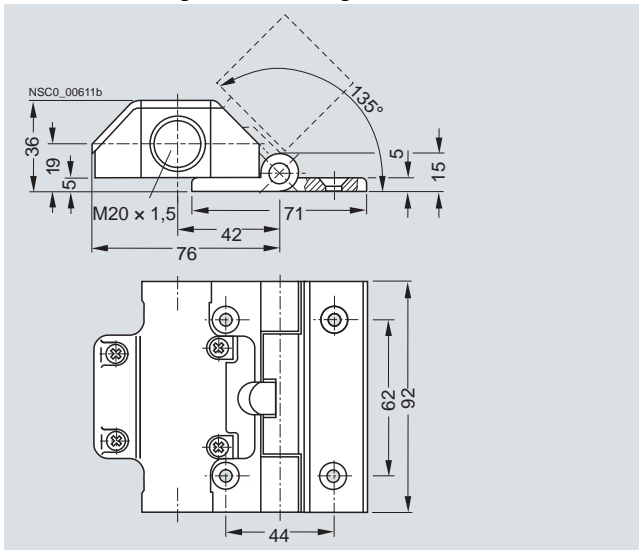

3SX3 225 additional hinge

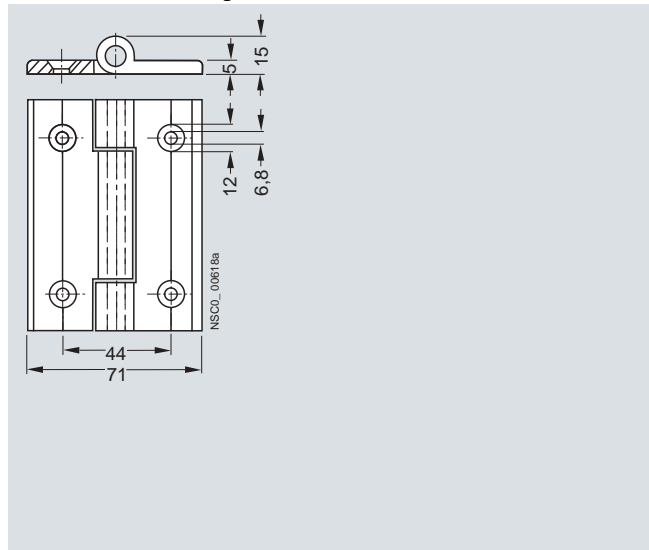

Operating travel of the hinge

Slow-action contacts

1 NO + 2 NC, Ident. No. 12

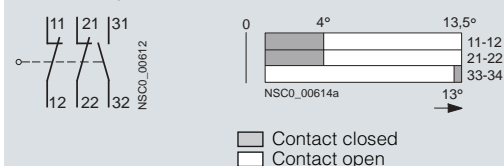

Slow-action contacts

3 NC, Ident. No. 03



3SE5, 3SE2 Position Switches

Hinge Switches

**3SE2, molded-plastic enclosures
With integrated hinge**

Selection and ordering data

3 contacts · Degree of protection IP65 · Cable entry 2 × (M20 × 1.5)

Version	Slow-action contacts	DT	Complete units	<input type="checkbox"/>	PU (UNIT, SET, M)	PS*	PG
			Order No.	Price per PU			

Molded-plastic enclosures with integrated hinge



3SE2 283

With integrated hinge

(Delivery includes additional hinge and fixing accessories)

• Aluminum hinge

- Operating angle 4°	1 NO + 2 NC	⊕ A	3SE2 283-0GA43	1	1 unit	102
- Operating angle 4°	3 NC	⊕ B	3SE2 283-6GA43	1	1 unit	102
- Operating angle 8°	1 NO + 2 NC	⊕ C	3SE2 283-0GA53	1	1 unit	102
- Operating angle 8°	3 NC	⊕ C	3SE2 283-6GA53	1	1 unit	102

• High-grade steel hinge

- Operating angle 4°	1 NO + 2 NC	⊕ B	3SE2 283-0GA44	1	1 unit	102
- Operating angle 4°	3 NC	⊕ C	3SE2 283-6GA44	1	1 unit	102

⊕ Positive opening according to IEC 60947-5-1, Appendix K.

Accessories/spare parts

Version	DT	Order No.	Price per PU	PU (UNIT, SET, M)	PS*	PG
---------	----	-----------	-----------------	-------------------------	-----	----

Accessories



3SX3 225

Additional hinges

(delivered with fixing accessories)

• Made of aluminum	⊕ D	3SX3 225	1	1 unit	102
• Made of high-grade steel	⊕ D	3SX3 231	1	1 unit	102

3SE5, 3SE2 Position Switches

For Explosion Protection (ATEX)

3SE5, metal enclosures
Enclosure width 31 mm / 40 mm / 56 mm

Overview



Position switches according to ATEX with grounding screw

Position switches in a metal enclosure including the hinge switch and the switch with a separate actuator are also available in versions for operation in areas with combustible dust.

These switches are not suitable for operation in areas with gas explosion hazard. An exception is the type of protection intrinsic safety i: Use as "simple electrical equipment" is possible (see Certificate No. 2849).

To achieve the maximum possible safety in these areas, the legislators of most countries have drawn up requirements in the form of laws, regulations and standards which these switches comply with to the letter.

These switches comply with Directive 94/9/EC II2D (ATEX 95) of the European Union and are approved for Zone 21/22.
See www.siemens.com/industrial-controls/atex.

They have a grounding screw on the outside of the enclosure but are otherwise identical with the standard enclosures. The connection openings are closed with protective caps upon delivery.

3SE5, 3SE2 Position Switches

For Explosion Protection (ATEX)

3SE5, metal enclosures
Enclosure width 31 mm according to EN 50047

Selection and ordering data

Modular system

2 or 3 contacts · Degree of protection IP66/IP67 · Cable entry M20 × 1.5

Version	Contacts	DT	Modular system	PU (UNIT, SET, M)	PS*	PG
						
			Order No.	Price per PU		

Basic switches • Enclosure width 31 mm according to EN 50047 (with rounded plunger¹⁾)



Rounded plunger

With M20 × 1.5 connecting thread

Slow-action contacts	1 NO + 1 NC	⊕ B	3SE5 212-0BC05-1DA0	1	1 unit	102
Snap-action contacts	1 NO + 1 NC	⊕ B	3SE5 212-0CC05-1DA0	1	1 unit	102
Slow-action contacts	1 NO + 2 NC	⊕ B	3SE5 212-0KC05-1DA0	1	1 unit	102
Snap-action contacts	1 NO + 2 NC	⊕ B	3SE5 212-0LC05-1DA0	1	1 unit	102
Slow-action contacts with make-before-break	1 NO + 2 NC	⊕ B	3SE5 212-0MC05-1DA0	1	1 unit	102
Slow-action contacts	2 NO + 1 NC	⊕ B	3SE5 212-0PC05-1DA0	1	1 unit	102

⊕ Positive opening according to IEC 60947-5-1, Appendix K, or positively driven actuator, necessary in safety circuits.

¹⁾ On enclosure width 31 mm the basic switch is a complete unit with rounded plunger.

Note: For selection aid, see page 9/12.

Version	Diameter	DT	Modular system	PU (UNIT, SET, M)	PS*	PG
						
	mm		Order No.	Price per PU		

Operating mechanisms



Plain plunger

Plain plungers

High-grade steel plungers	10	⊕ A	3SE5 000-0AB01	1	1 unit	102
---------------------------	----	-----	-----------------------	---	--------	-----



Roller plunger

Roller plungers, type C acc. to EN 50047

Plastic rollers	10	⊕ A	3SE5 000-0AD03	1	1 unit	102
High-grade steel rollers	10	⊕ B	3SE5 000-0AD04	1	1 unit	102



With central
fixing









Roller plungers with central fixing

Plastic rollers	10	⊕ B	3SE5 000-0AD10	1	1 unit	102
High-grade steel rollers	10	⊕ B	3SE5 000-0AD11	1	1 unit	102

3SE5, 3SE2 Position Switches

For Explosion Protection (ATEX)

3SE5, metal enclosures
Enclosure width 31 mm according to EN 50047

Version	Diameter	DT	Modular system	PU (UNIT, SET, M)	PS*	PG
	mm		Order No.	Price per PU		
Operating mechanisms						
	Roller levers, type E acc. to EN 50047					
	Metal lever, plastic roller	13	⊕ A	3SE5 000-0AE10	1	1 unit 102
	Metal lever, high-grade steel roller	13	⊕ B	3SE5 000-0AE11	1	1 unit 102
	High-grade steel lever, plastic roller	13	⊕ B	3SE5 000-0AE12	1	1 unit 102
	Angular roller levers					
	Metal lever, plastic roller	13	⊕ A	3SE5 000-0AF10	1	1 unit 102
	Metal lever, high-grade steel roller	13	⊕ B	3SE5 000-0AF11	1	1 unit 102
	High-grade steel lever, plastic roller	13	⊕ A	3SE5 000-0AF12	1	1 unit 102
	Spring rods (for switches with snap-action contacts only)					
	Plastic plunger:					
	• Length 142.5 mm (spring 50 mm, plunger 50 mm)		B	3SE5 000-0AR01	1	1 unit 102
	• Length 76 mm (spring 23.5 mm, plunger 10 mm)		B	3SE5 000-0AR03	1	1 unit 102
	Twist actuators, plastic (without lever)					
	Switching right and/or left, adjustable		⊕ A	3SE5 000-0AK00	1	1 unit 102
	Levers for twist actuators					
	Metal lever 21 mm, plastic roller	19	⊕ A	3SE5 000-0AA21	1	1 unit 102
	Metal lever 21 mm, high-grade steel roller	19	⊕ B	3SE5 000-0AA22	1	1 unit 102
	Metal lever 21 mm, roller with ball bearing	19	⊕ B	3SE5 000-0AA23	1	1 unit 102
	Metal lever 21 mm, plastic roller	30	⊕ B	3SE5 000-0AA25	1	1 unit 102
	High-grade steel lever 21 mm, plastic roller	19	⊕ B	3SE5 000-0AA31	1	1 unit 102
	High-grade steel lever 21 mm, high-grade steel roller	19	⊕ B	3SE5 000-0AA32	1	1 unit 102
	Twist levers 30 mm, straight¹⁾					
Metal lever, plastic roller	19	⊕ B	3SE5 000-0AA24	1	1 unit 102	
Metal lever, plastic roller	30	⊕ B	3SE5 000-0AA26	1	1 unit 102	
	Twist levers, adjustable length, with grid hole					
	Metal lever, plastic roller	19	⊕ B	3SE5 000-0AA60	1	1 unit 102
	Metal lever, high-grade steel roller	19	⊕ B	3SE5 000-0AA61	1	1 unit 102
	Metal lever, plastic roller	50	⊕ B	3SE5 000-0AA67	1	1 unit 102
	Metal lever, rubber roller	50	⊕ B	3SE5 000-0AA68	1	1 unit 102
	High-grade steel lever, plastic roller	19	⊕ B	3SE5 000-0AA62	1	1 unit 102
	Twist levers, adjustable length					
	Metal lever, plastic roller	19	A	3SE5 000-0AA50	1	1 unit 102
	Metal lever, high-grade steel roller	19	B	3SE5 000-0AA51	1	1 unit 102
	Metal lever, plastic roller	30	B	3SE5 000-0AA55	1	1 unit 102
	Metal lever, plastic roller	50	B	3SE5 000-0AA57	1	1 unit 102
	Metal lever, rubber roller	50	B	3SE5 000-0AA58	1	1 unit 102
	Rod actuators, type D acc. to EN 50041					
	Aluminum rod, length 200 mm	6	B	3SE5 000-0AA80	1	1 unit 102
	Spring rod, length 200 mm	6	B	3SE5 000-0AA81	1	1 unit 102
	Plastic rod, length 200 mm	6	B	3SE5 000-0AA82	1	1 unit 102
	Plastic rod, length 330 mm	6	B	3SE5 000-0AA83	1	1 unit 102

⊕ Positively driven actuator, necessary in safety circuits.

¹⁾ Can be clinch mounted (turned through 180°, rear of lever).

3SE5, 3SE2 Position Switches

For Explosion Protection (ATEX)

3SE5, metal enclosures
Enclosure width 31 mm according to EN 50047

Position switches with separate actuator · Complete units

5 directions of approach · 3 contacts · Degree of protection IP66/IP67 · Cable entry M20 × 1.5

Version ¹⁾	Contacts	DT	Complete units	PU (UNIT, SET, M)	PS*	PG
			<input type="checkbox"/>			
			Order No.	Price per PU		

Enclosure width 31 mm according to EN 50047



With separate
actuator

With M20 × 1.5 connecting thread

Slow-action contacts

1 NO + 2 NC  B

3SE5 212-0QV40-1DA0

1 1 unit 102

 Positive opening according to IEC 60947-5-1, Appendix K.

¹⁾ Supplied without actuator. Please order separately ([see page 9/59](#)).

Hinge switches · Complete units

3 contacts · Degree of protection IP66/IP67 · Cable entry M20 × 1.5

Version	Snap-action contacts	DT	Complete units	PU (UNIT, SET, M)	PS*	PG
			<input type="checkbox"/>			
			Order No.	Price per PU		

Enclosure width 31 mm according to EN 50047



With hollow shaft

With hollow shaft, Ø 8/12 mm

Operating angle 10°

1 NO + 2 NC  B

3SE5 212-0LU21-1DA0

1 1 unit 102



With solid shaft

With solid shaft, Ø = 10 mm

Operating angle 10°

1 NO + 2 NC  B

3SE5 212-0LU22-1DA0

1 1 unit 102

 Positive opening according to IEC 60947-5-1, Appendix K, or positively driven actuator, usable in safety circuits.

3SE5, 3SE2 Position Switches





For Explosion Protection (ATEX)

3SE5, metal enclosures
Enclosure width 40 mm acc. to EN 50041/56 mm

Selection and ordering data

Complete units

2 contacts · Degree of protection IP66/IP67 · Cable entry M20 × 1.5

Version	Snap-action contacts	DT	Complete units	Order No.	Price per PU	PU (UNIT, SET, M)	PS*	PG
Enclosure width 40 mm according to EN 50041								
With M20 × 1.5 connecting thread								
	Snap-action contacts	1 NO + 1 NC						
Rounded plunger	• Rounded plungers, high-grade steel, with 3 mm overtravel	⊕ B	3SE5 112-0CC02-1DA0			1	1 unit	102
	• Roller plungers, high-grade steel roller, with 3 mm overtravel	⊕ B	3SE5 112-0CD02-1DA0			1	1 unit	102
	• Roller levers, high-grade steel lever, plastic roller	⊕ B	3SE5 112-0CE03-1DA0			1	1 unit	102
	• Angular roller levers, high-grade steel lever, plastic roller	⊕ B	3SE5 112-0CF03-1DA0			1	1 unit	102
	• Spring rods, length 142.5 mm Plastic plunger	B	3SE5 112-0CR01-1DA0			1	1 unit	102
	• Twist levers, high-grade steel lever, plastic roller	⊕ B	3SE5 112-0CH11-1DA0			1	1 unit	102
	• Twist levers, adjustable length High-grade steel lever, plastic roller	B	3SE5 112-0CH52-1DA0			1	1 unit	102
	• Fork levers, high-grade steel lever, plastic roller	⊕ B	3SE5 112-0CT13-1DA0			1	1 unit	102
	• Rod actuators, aluminum rod, length 200 mm	B	3SE5 112-0CH80-1DA0			1	1 unit	102
	• Rod actuators, plastic rod, length 200 mm	B	3SE5 112-0CH82-1DA0			1	1 unit	102
Enclosure width 56 mm								
With 3 x M20 x 1.5 connecting thread								
	Snap-action contacts	1 NO + 1 NC						
Roller plunger	• Rounded plungers, high-grade steel, with overtravel	⊕ B	3SE5 122-0CC02-1DA0			1	1 unit	102
	• Roller plungers, high-grade steel roller	⊕ B	3SE5 122-0CD02-1DA0			1	1 unit	102
	• Roller levers, high-grade steel lever, plastic roller	⊕ B	3SE5 122-0CE03-1DA0			1	1 unit	102
	• Angular roller levers, high-grade steel lever, plastic roller	⊕ B	3SE5 122-0CF03-1DA0			1	1 unit	102
	• Spring rods, length 142.5 mm Plastic plunger	B	3SE5 122-0CR01-1DA0			1	1 unit	102
	• Twist levers, high-grade steel lever, plastic roller	⊕ B	3SE5 122-0CH11-1DA0			1	1 unit	102

⊕ Positive opening according to IEC 60947-5-1, Appendix K

Note: If the device you require is not available as a complete unit, see "Modular system" on the next page.



3SE5, 3SE2 Position Switches

For Explosion Protection (ATEX)

3SE5, metal enclosures
Enclosure width 40 mm acc. to EN 50041/56 mm





Modular system

2 or 3 contacts · Degree of protection IP66/IP67 · Cable entry M20 × 1.5

Version	Contacts	DT	Modular system	PU (UNIT, SET, M)	PS*	PG	
			Order No.	Price per PU			
Basic switches • Enclosure width 40 mm acc. to EN 50041							
 Basic switch	With M20 × 1.5 connecting thread						
	Slow-action contacts	1 NO + 1 NC	⊕ B	3SE5 112-0BA00-1DA0	1	1 unit	102
	Snap-action contacts	1 NO + 1 NC	⊕ B	3SE5 112-0CA00-1DA0	1	1 unit	102
	Slow-action contacts	1 NO + 2 NC	⊕ B	3SE5 112-0KA00-1DA0	1	1 unit	102
	Snap-action contacts	1 NO + 2 NC	⊕ B	3SE5 112-0LA00-1DA0	1	1 unit	102
	Slow-action contacts with make-before-break	1 NO + 2 NC	⊕ B	3SE5 112-0MA00-1DA0	1	1 unit	102
Slow-action contacts	2 NO + 1 NC	⊕ B	3SE5 112-0PA00-1DA0	1	1 unit	102	
Basic switches • Enclosure width 56 mm							
 Basic switch	With 3 × M20 × 1.5 connecting thread						
	Slow-action contacts	1 NO + 1 NC	⊕ B	3SE5 122-0BA00-1DA0	1	1 unit	102
	Snap-action contacts	1 NO + 1 NC	⊕ B	3SE5 122-0CA00-1DA0	1	1 unit	102
	Slow-action contacts	1 NO + 2 NC	⊕ B	3SE5 122-0KA00-1DA0	1	1 unit	102
	Snap-action contacts	1 NO + 2 NC	⊕ B	3SE5 122-0LA00-1DA0	1	1 unit	102
	Slow-action contacts with make-before-break	1 NO + 2 NC	⊕ B	3SE5 122-0MA00-1DA0	1	1 unit	102
Slow-action contacts	2 NO + 1 NC	⊕ B	3SE5 122-0PA00-1DA0	1	1 unit	102	
Basic switches • Enclosure width 56 mm, XL							
 Basic switch	With 3 × M20 × 1.5 connecting thread						
	Slow-action contacts	2 × (1 NO + 1 NC)	⊕ B	3SE5 162-0BA00-1DA0	1	1 unit	102
	Snap-action contacts	2 × (1 NO + 1 NC)	⊕ B	3SE5 162-0CA00-1DA0	1	1 unit	102
Slow-action contacts with make-before-break	2 × (1 NO + 2 NC)	⊕ B	3SE5 162-0DA00-1DA0	1	1 unit	102	

⊕ Positive opening according to IEC 60947-5-1, Appendix K, or positively driven actuator, necessary in safety circuits.

Note: For selection aid, see page 9/12.

Version	Diameter	DT	Modular system	PU (UNIT, SET, M)	PS*	PG	
			Order No.	Price per PU			
Operating mechanisms							
 Rounded plunger	Plain plungers						
	High-grade steel plungers		⊕ A	3SE5 000-0AB01	1	1 unit	102
 Roller plunger	Rounded plungers, type B, acc. to EN 50041						
	High-grade steel plungers, with 3 mm overtravel		⊕ B	3SE5 000-0AC02	1	1 unit	102
 Roller lever	Roller plungers, type C acc. to EN 50041						
	High-grade steel roller, with 3 mm overtravel	13	⊕ B	3SE5 000-0AD02	1	1 unit	102
 Angular roller lever	Roller levers						
	Metal lever, plastic roller	22	⊕ A	3SE5 000-0AE01	1	1 unit	102
	Metal lever, high-grade steel roller	22	⊕ B	3SE5 000-0AE02	1	1 unit	102
	High-grade steel lever, plastic roller	22	⊕ B	3SE5 000-0AE03	1	1 unit	102
 Angular roller lever	Angular roller levers						
	Metal lever, plastic roller	22	⊕ A	3SE5 000-0AF01	1	1 unit	102
	Metal lever, high-grade steel roller	22	⊕ B	3SE5 000-0AF02	1	1 unit	102
	High-grade steel lever, plastic roller	22	⊕ B	3SE5 000-0AF03	1	1 unit	102
High-grade steel lever, high-grade steel roller	22	⊕ B	3SE5 000-0AF04	1	1 unit	102	







⊕ Positively driven actuator, necessary in safety circuits.

* You can order this quantity or a multiple thereof.
Illustrations are approximate

3SE5, 3SE2 Position Switches

For Explosion Protection (ATEX)

3SE5, metal enclosures
Enclosure width 40 mm acc. to EN 50041/56 mm

Version	Diameter	DT	Modular system	PU (UNIT, SET, M)	PS*	PG
	mm		Order No.	Price per PU		
Operating mechanisms						
	Spring rods (for switches with snap-action contacts only)					
	Plastic plunger:					
	• Length 142.5 mm (spring 50 mm, plunger 50 mm)	B	3SE5 000-0AR01	1	1 unit	102
	• Length 76 mm (spring 23.5 mm, plunger 10 mm)	B	3SE5 000-0AR03	1	1 unit	102
	• Length 242.5 mm (spring 150 mm, plunger 50 mm)	B	3SE5 000-0AR04	1	1 unit	102
High-grade steel plunger:						
Spring rod	• Length 142.5 mm (spring 50 mm, plunger 50 mm)	B	3SE5 000-0AR02	1	1 unit	102
Twist actuators						
	Twist actuators , metal (without lever)					
	• For twist levers and rod actuators, switching right and/or left, adjustable					
	- For enclosure width 40 and 56 mm	⊕ A	3SE5 000-0AH00	1	1 unit	102
• For fork levers, latching	⊕ B	3SE5 000-0AT10	1	1 unit	102	
Levers for twist actuators						
Twist levers 27 mm, offset, type A, acc. to EN 50041						
	Metal lever, plastic roller	19	⊕ A	3SE5 000-0AA01	1	1 unit 102
	Metal lever, high-grade steel roller	19	⊕ A	3SE5 000-0AA02	1	1 unit 102
	Metal lever, roller with ball bearing	19	⊕ B	3SE5 000-0AA03	1	1 unit 102
	Metal lever, 2 plastic rollers	19	⊕ B	3SE5 000-0AA04	1	1 unit 102
	Metal lever, plastic roller	30	⊕ B	3SE5 000-0AA05	1	1 unit 102
	Metal lever, rubber roller	50	⊕ B	3SE5 000-0AA08	1	1 unit 102
	High-grade steel lever, plastic roller	19	⊕ B	3SE5 000-0AA11	1	1 unit 102
	High-grade steel lever, high-grade steel roller	19	⊕ B	3SE5 000-0AA12	1	1 unit 102
Twist levers 35 mm, offset						
Metal lever, plastic roller	19	⊕ B	3SE5 000-0AA15	1	1 unit 102	
Twist levers 30 mm, straight¹⁾						
	Metal lever, plastic roller	19	⊕ B	3SE5 000-0AA24	1	1 unit 102
	Metal lever, plastic roller	30	⊕ B	3SE5 000-0AA26	1	1 unit 102
Twist levers, adjustable length, with grid hole						
	Metal lever, plastic roller	19	⊕ B	3SE5 000-0AA60	1	1 unit 102
	Metal lever, high-grade steel roller	19	⊕ B	3SE5 000-0AA61	1	1 unit 102
	Metal lever, rubber roller	50	⊕ B	3SE5 000-0AA68	1	1 unit 102
	High-grade steel lever, plastic roller	19	⊕ B	3SE5 000-0AA62	1	1 unit 102
	High-grade steel lever, high-grade steel roller	19	⊕ B	3SE5 000-0AA63	1	1 unit 102
	Twist levers, adjustable length					
	Metal lever, plastic roller	19	A	3SE5 000-0AA50	1	1 unit 102
	Metal lever, high-grade steel roller	19	B	3SE5 000-0AA51	1	1 unit 102
	Metal lever, plastic roller	30	B	3SE5 000-0AA55	1	1 unit 102
	Metal lever, rubber roller	50	B	3SE5 000-0AA58	1	1 unit 102
	High-grade steel lever, plastic roller	19	B	3SE5 000-0AA52	1	1 unit 102
	High-grade steel lever, high-grade steel roller	19	B	3SE5 000-0AA53	1	1 unit 102
Fork levers (for switches with snap-action contacts only)						
	2 metal levers, 2 plastic rollers	19	⊕ B	3SE5 000-0AT01	1	1 unit 102
	2 metal levers, 2 high-grade steel rollers	19	⊕ B	3SE5 000-0AT02	1	1 unit 102
	2 high-grade steel levers, 2 plastic rollers	19	⊕ B	3SE5 000-0AT03	1	1 unit 102
	2 high-grade steel levers, 2 high-grade steel rollers	19	⊕ B	3SE5 000-0AT04	1	1 unit 102
	Rod actuators, type D, acc. to EN 50041					
Aluminum rod, length 200 mm	6	B	3SE5 000-0AA80	1	1 unit 102	
Spring rod, length 200 mm	6	B	3SE5 000-0AA81	1	1 unit 102	
Plastic rod, length 200 mm	6	B	3SE5 000-0AA82	1	1 unit 102	

⊕ Positively driven actuator, necessary in safety circuits.

¹⁾ Can be clinch mounted (turned through 180°, rear of lever).



3SE5, 3SE2 Position Switches

For Explosion Protection (ATEX)

3SE5, metal enclosures
Enclosure width 40 mm acc. to EN 50041/56 mm

Position switches with separate actuator · Complete units

5 directions of approach · 3 contacts · Degree of protection IP66/IP67 · Cable entry M20 × 1.5

Version ¹⁾	Contacts	DT	Complete units	PU (UNIT, SET, M)	PS*	PG
			Order No.	Price per PU		
Enclosure width 40 mm according to EN 50041						
	With M20 × 1.5 connecting thread Slow-action contacts	1 NO + 2 NC ⊕ B	3SE5 112-0QV10-1DA0	1	1 unit	102
Enclosure width 56 mm						
	With 3 x M20 x 1.5 connecting thread Slow-action contacts	1 NO + 2 NC ⊕ B	3SE5 122-0QV10-1DA0	1	1 unit	102

With separate actuator



With separate actuator

⊕ Positive opening according to IEC 60947-5-1, Appendix K.

¹⁾ Supplied without actuator. Please order separately (see page 9/59).

Hinge switches · Complete units

3 contacts · Degree of protection IP66/IP67 · Cable entry M20 × 1.5

Version	Snap-action contacts	DT	Complete units	PU (UNIT, SET, M)	PS*	PG
			Order No.	Price per PU		
Enclosure width 40 mm according to EN 50041						
	With hollow shaft, Ø 8/12 mm Operating angle 10°	1 NO + 2 NC ⊕ B	3SE5 112-0LU21-1DA0	1	1 unit	102
	With solid shaft, Ø = 10 mm Operating angle 10°	1 NO + 2 NC ⊕ B	3SE5 112-0LU22-1DA0	1	1 unit	102

With hollow shaft

With solid shaft

⊕ Positive opening according to IEC 60947-5-1, Appendix K, or positively driven actuator, usable in safety circuits.

3SF1 AS-Interface Position Switches

General data

Overview

The 3SF1 position switches with safety-oriented communication can be directly connected using the AS-Interface bus system. The safety functions no longer have to be conventionally wired up.

With the 3SF1 position switches the ASIsafe electronics are integrated in the switch enclosure.



Examples of selection options in the modular system

Modular system

The position switches of the 3SF1 1.4 and 3SF1 2.4 series are constructed from a modular system comprising different versions of the basic switch and an actuator which must be ordered separately. Thanks to the modular design of the switch the end user can select the right solution for his application from numerous versions and install it himself in a very short time.

Design

The 3SF1 switches are available in four different enclosure sizes:

- Plastic and metal enclosures according to EN 50047, 31 mm wide, with M12 connector socket
- Molded-plastic and metal enclosures according to EN 50041, 40 mm wide, with M12 connector socket
- Molded-plastic enclosures, 50 mm wide, with M12 plug and M12 socket
- Metal enclosures, 56 mm wide, with M12 plug and M12 socket

Display

The switches have a status display with three LEDs:

- LED 1 (yellow): F-IN1
- LED 2 (yellow): F-IN2
- LED 3 (green/red): AS-I/FAULT

Connection

Connection to the AS-Interface is by means of a 4-pole M12 connector socket (plastic version) connected to the yellow AS-Interface bus cable.

The wide enclosures (50 or 56 mm) also have an M12 socket for connecting a second position switch. Category 4 according to EN 954-1 is thus achieved.

Benefits

The new generation of 3SF1 position switches offers:

- ASIsafe Electronics integrated in the enclosure, with low power consumption < 60 mA
- An extensive range of actuators
- Status display with three LEDs

Application

With the standard position switches, mechanical positions of moved machine parts are converted into electrical signals. Through their modular and uniform design and large number of variants, the devices can meet practically all requirements in industry.

Devices are available with enclosure versions to suit the particular ambient conditions. Different control tasks can be performed with the best contact blocks suited for the particular purpose. And many different actuator variants are available to match the mechanical configuration of the moved machined parts. Dimensions, fixing points and characteristics are largely in accordance with the EN 50041 or EN 50047 standards.

The devices are suitable for use in any climate.

Standards

The switches comply with the standards IEC 60947-1 (Low-Voltage Switchgear and Controlgear, General) and IEC 60947-5-1 (Electromechanical Control Circuit Devices).

The mechanical design of the switch corresponds to the requirements of the failsafe principle according to EN 1088.

Approvals

AS-Interface according to EN 50295 and IEC 62026-2.

With a 3SF1 position switch it is possible to achieve category 2 according to ISO 13849-1 (EN 954-1) or SIL 1 according to IEC 61508.

Categories 3 or 4 according to ISO 13849-1 (EN 954-1) or SIL 2 or 3 according to IEC 61508 can be achieved by using a second 3SE5 position switch.

The 3SF1 position switches are approved according to UL 508, UL 50 and UL 746-C.

More information

Type	3SF1 1.., 3SF1 2..	
General data		
Standards	IEC 60947-5-1, EN 60947-5-1, EN 1088	
According to AS-Interface specification		
• I/O configuration / ID configuration		7/B
• ID1 code/ID2 code (Hex)		F/F
• Power consumption, overall	mA	≤ 60
Inputs		
• Low signal range		Contact open
• High signal range		Contact closed, I_{in} dynamic ($I_{peak} \geq 5$ mA)
Status display	Green/red dual LED	
Rated impulse withstand voltage U_{imp}	kV	0.6
EMC resistance		
• EN 60000-1-2	kV	4
• EN 60000-4-3	V/m	10
• EN 60000-4-4 (A/B)	kV	1 / 2
Mechanical endurance		
• Basic switches		15×10^6 operating cycles
• With separate actuator, 3SF1 ...-..V..		1×10^6 operating cycles
PFH value		
Probability of failure upon request of the safety function, with 1 actuation per hour and $B_{10} = 5 \times 10^9$		
• Basic switches		4×10^{-9} 1/h
• With separate actuator, 3SF1 ...-..V..		2×10^{-9} 1/h
• Hinge switch, 3SF1 ...-..U..		2×10^{-9} 1/h
Shock resistance acc. to IEC 60068-2-27	30 g/11 ms	

Type	3SF1 234	3SF1 134	3SF1 244	3SF1 214	3SF1 114	3SF1 124
Enclosures						
Enclosures	Ultradim A3X2G7			Zinc diecasting GD Zn Al4 Cu1		
• Material						
• Width	mm	31	40	50	31	40
• Dimensions acc. to EN		EN 50047	EN 50041	--	EN 50047	EN 50041
Degree of protection acc. to EN 60529		IP65	IP66/IP67 ¹⁾			
Ambient temperature						
• During operation	°C	-25 ... +60				
• Storage, transport	°C	-40 ... +80				
Mounting position	Any					

¹⁾ For twist actuators with spring rod and rod actuators: IP65/IP67.

Connector assignment

M12 connector socket, 4-pole

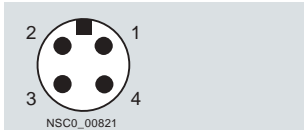

- 1 ASi +
- 2 Not assigned
- 3 ASi -
- 4 Not assigned

M12 socket, 4-pole

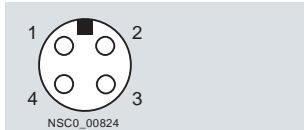

- 1 Channel 2
- 2 Not assigned
- 3 Channel 2
- 4 Not assigned

LEDs

Status display (operating state)

LEDs	No voltage on AS-Interface chip	Communication OK	Communication failed	Slave has address "0"
ASi/Fault (GN/RD)				

Safe inputs

LEDs	Not actuated	Actuated		
F-IN1 (YE)				
F-IN2 (YE)				

3SF1 AS-Interface Position Switches

Molded-plastic enclosures
Enclosure width 31 mm acc. to EN 50047/50 mm

Selection and ordering data

Modular system

For the ASIsafe version of the position switch, the basic switch and actuator must be ordered separately.

1 or 2 contacts · 3 LEDs · Degree of protection IP65 (31 mm) or IP66/IP67 (50 mm) · M12 connector socket

Version	Contacts	LEDs	DT	Modular system	PU (UNIT, SET, M)	PS*	PG
							
				Order No.	Price per PU		

Basic switches (with rounded plunger¹⁾) - Enclosure width 31 mm according to EN 50047



With teflon plunger

With M12 connector socket, 4-pole, channel 1 on NC contact, channel 2 on NC contact

Slow-action contacts	2 NC	24 V DC		B	3SF1 234-1KC05-1BA1	1	1 unit	121
Snap-action contacts	2 NC	24 V DC		B	3SF1 234-1LC05-1BA1	1	1 unit	121

ASIsafe basic switch

Basic switches (with rounded plunger¹⁾) - Enclosure width 50 mm



With teflon plunger

With M12 connector socket, 4-pole, channel 1 on NC contact, channel 2 on M12 socket, right

Slow-action contacts	1 NC	24 V DC		B	3SF1 244-1KC05-1BA2	1	1 unit	121
Snap-action contacts	1 NC	24 V DC		B	3SF1 244-1LC05-1BA2	1	1 unit	121









ASIsafe basic switch

 Positive opening according to IEC 60947-5-1, Appendix K, or positively driven actuator, usable in safety circuits.

¹⁾ On enclosure widths 31 mm and 50 mm the basic switch is a complete unit with rounded plunger.

Note: For selection aid, see page 9/12.

Molded-plastic enclosures
Enclosure width 31 mm acc. to EN 50047/50 mm

Version	Roller diameter	DT	Modular system		PU (UNIT, SET, M)	PS*	PG	
	mm		Order No.	Price per PU				
Operating mechanisms								
 Roller plunger	Roller plungers, type C acc. to EN 50047							
	Plastic rollers	10	⊕ A	3SE5 000-0AD03	1	1 unit	102	
	High-grade steel rollers	10	⊕ B	3SE5 000-0AD04	1	1 unit	102	
 With central fixing	Roller plungers with central fixing							
	Plastic rollers	10	⊕ B	3SE5 000-0AD10	1	1 unit	102	
	High-grade steel rollers	10	⊕ B	3SE5 000-0AD11	1	1 unit	102	
 Roller lever	Roller levers, type E acc. to EN 50047							
	Metal lever, plastic roller	13	⊕ A	3SE5 000-0AE10	1	1 unit	102	
	Metal lever, high-grade steel roller	13	⊕ B	3SE5 000-0AE11	1	1 unit	102	
	High-grade steel lever, plastic roller	13	⊕ B	3SE5 000-0AE12	1	1 unit	102	
	High-grade steel lever, high-grade steel roller	13	⊕ B	3SE5 000-0AE13	1	1 unit	102	
 Angular roller lever	Angular roller levers							
	Metal lever, plastic roller	13	⊕ A	3SE5 000-0AF10	1	1 unit	102	
	Metal lever, high-grade steel roller	13	⊕ B	3SE5 000-0AF11	1	1 unit	102	
	High-grade steel lever, plastic roller	13	⊕ A	3SE5 000-0AF12	1	1 unit	102	
	High-grade steel lever, high-grade steel roller	13	⊕ B	3SE5 000-0AF13	1	1 unit	102	
Twist actuators with lever								
 Twist actuator	Twist actuators, plastic (without lever)							
	Switching right or left, adjustable		⊕ A	3SE5 000-0AK00	1	1 unit	102	
Levers for twist actuators								
 Twist lever	Twist levers, type A acc. to EN 50047							
	Metal lever, plastic roller	19	⊕ A	3SE5 000-0AA21	1	1 unit	102	
	Metal lever, high-grade steel roller	19	⊕ B	3SE5 000-0AA22	1	1 unit	102	
	Metal lever, roller with ball bearing	19	⊕ B	3SE5 000-0AA23	1	1 unit	102	
	Metal lever, plastic roller	30	⊕ B	3SE5 000-0AA25	1	1 unit	102	
	High-grade steel lever, plastic roller	19	⊕ B	3SE5 000-0AA31	1	1 unit	102	
	High-grade steel lever, high-grade steel roller	19	⊕ B	3SE5 000-0AA32	1	1 unit	102	
 Twist lever, adjustable length	Twist levers 30 mm, straight¹⁾							
	Metal lever, plastic roller	19	⊕ B	3SE5 000-0AA24	1	1 unit	102	
	Metal lever, plastic roller	30	⊕ B	3SE5 000-0AA26	1	1 unit	102	
	Twist levers, adjustable length, with grid hole							
	Metal lever, plastic roller	19	⊕ B	3SE5 000-0AA60	1	1 unit	102	
	Metal lever, high-grade steel roller	19	⊕ B	3SE5 000-0AA61	1	1 unit	102	
	Metal lever, plastic roller	50	⊕ B	3SE5 000-0AA67	1	1 unit	102	
	Metal lever, rubber roller	50	⊕ B	3SE5 000-0AA68	1	1 unit	102	
	High-grade steel lever, plastic roller	19	⊕ B	3SE5 000-0AA62	1	1 unit	102	
	High-grade steel lever, high-grade steel roller	19	⊕ B	3SE5 000-0AA63	1	1 unit	102	

⊕ Positively driven actuator, usable in safety circuits.

¹⁾ Can be clinch mounted (turned through 180°, rear of lever).

3SF1 AS-Interface Position Switches

Metal enclosures
Enclosure width 31 mm according to EN 50047

Selection and ordering data

Modular system

For the ASIsafe version of the position switch, the basic switch and actuator must be ordered separately.

2 contacts · 3 LEDs · Degree of protection IP66/IP67 · M12 connector socket

Version	Contacts	LEDs	DT	Modular system	PU (UNIT, SET, M)	PS*	PG
				<input checked="" type="checkbox"/>			
				Order No.	Price per PU		

Basic switches (with rounded plunger¹⁾) - Enclosure width 31 mm according to EN 50047



With plunger

With M12 connector socket, 4-pole,
channel 1 on NC contact,
channel 2 on NC contact

Slow-action contacts	2 NC	24 V DC	⊕ B	3SF1 214-1KC05-1BA1	1	1 unit	121
Snap-action contacts	2 NC	24 V DC	⊕ B	3SF1 214-1LC05-1BA1	1	1 unit	121









ASIsafe basic switch

⊕ Positive opening according to IEC 60947-5-1, Appendix K, or positively driven actuator, usable in safety circuits.

¹⁾ On enclosure width 31 mm the basic switch is a complete unit with rounded plunger.

Note: For selection aid, see page 9/12.

Metal enclosures
Enclosure width 31 mm according to EN 50047

Version	Plunger or roller diameter	DT	Modular system	PU (UNIT, SET, M)	PS*	PG
	mm		Order No.	Price per PU		
Operating mechanisms						
	Plain plungers High-grade steel plungers	10	⊕ A	3SE5 000-0AB01	1	1 unit 102
Plain plunger						
	Roller plungers, type C acc. to EN 50047 Plastic rollers High-grade steel rollers	10 10	⊕ A ⊕ B	3SE5 000-0AD03 3SE5 000-0AD04	1 1	1 unit 102 1 unit 102
Roller plunger						
	Roller plungers with central fixing Plastic rollers High-grade steel rollers	10 10	⊕ B ⊕ B	3SE5 000-0AD10 3SE5 000-0AD11	1 1	1 unit 102 1 unit 102
With central fixing						
	Roller levers, type E acc. to EN 50047 Metal lever, plastic roller Metal lever, high-grade steel roller High-grade steel lever, plastic roller High-grade steel lever, high-grade steel roller	13 13 13 13	⊕ A ⊕ B ⊕ B ⊕ B	3SE5 000-0AE10 3SE5 000-0AE11 3SE5 000-0AE12 3SE5 000-0AE13	1 1 1 1	1 unit 102 1 unit 102 1 unit 102 1 unit 102
Roller lever						
	Angular roller levers Metal lever, plastic roller Metal lever, high-grade steel roller High-grade steel lever, plastic roller High-grade steel lever, high-grade steel roller	13 13 13 13	⊕ A ⊕ B ⊕ A ⊕ B	3SE5 000-0AF10 3SE5 000-0AF11 3SE5 000-0AF12 3SE5 000-0AF13	1 1 1 1	1 unit 102 1 unit 102 1 unit 102 1 unit 102
Angular roller lever						
Twist actuators with lever						
	Twist actuators, plastic (without lever) Switching right or left, adjustable		⊕ A	3SE5 000-0AK00	1	1 unit 102
Twist actuator						
Levers for twist actuators						
	Twist levers, type A acc. to EN 50047 Metal lever, plastic roller Metal lever, high-grade steel roller Metal lever, roller with ball bearing Metal lever, plastic roller High-grade steel lever, plastic roller High-grade steel lever, high-grade steel roller	19 19 19 30 19 19	⊕ A ⊕ B ⊕ B ⊕ B ⊕ B ⊕ B	3SE5 000-0AA21 3SE5 000-0AA22 3SE5 000-0AA23 3SE5 000-0AA25 3SE5 000-0AA31 3SE5 000-0AA32	1 1 1 1 1 1	1 unit 102 1 unit 102 1 unit 102 1 unit 102 1 unit 102 1 unit 102
Twist lever						
	Twist levers 30 mm, straight¹⁾ Metal lever, plastic roller Metal lever, plastic roller	19 30	⊕ B ⊕ B	3SE5 000-0AA24 3SE5 000-0AA26	1 1	1 unit 102 1 unit 102
Twist lever, adjustable length						
	Twist levers, adjustable length, with grid hole Metal lever, plastic roller Metal lever, high-grade steel roller Metal lever, plastic roller Metal lever, rubber roller High-grade steel lever, plastic roller High-grade steel lever, high-grade steel roller	19 19 50 50 19 19	⊕ B ⊕ B ⊕ B ⊕ B ⊕ B ⊕ B	3SE5 000-0AA60 3SE5 000-0AA61 3SE5 000-0AA67 3SE5 000-0AA68 3SE5 000-0AA62 3SE5 000-0AA63	1 1 1 1 1 1	1 unit 102 1 unit 102 1 unit 102 1 unit 102 1 unit 102 1 unit 102
Twist lever, adjustable length						

⊕ Positively driven actuator, usable in safety circuits.

¹⁾ Can be clinch mounted (turned through 180°, rear of lever).

3SF1 AS-Interface Position Switches

Metal enclosures

Enclosure width 40 mm acc. to EN 50041/56 mm

Selection and ordering data

Modular system

For the ASIsafe version of the position switch, the basic switch and actuator must be ordered separately.

1 or 2 contacts · 3 LEDs · Degree of protection IP66/IP67 · M12 connector socket

Version	Contacts	LEDs	DT	Modular system	PU (UNIT, SET, M)	PS*	PG
				<input type="checkbox"/>			
				Order No.	Price per PU		

Basic switches - Enclosure width 40 mm according to EN 50041



With M12 connector socket, 4-pole, channel 1 on NC contact, channel 2 on NC contact

Slow-action contacts	2 NC	24 V DC	⊕ B	3SF1 114-1KA00-1BA1	1	1 unit	121
Snap-action contacts	2 NC	24 V DC	⊕ B	3SF1 114-1LA00-1BA1	1	1 unit	121

ASIsafe basic switch

Basic switches - Enclosure width 56 mm



With M12 connector socket, 4-pole, channel 1 on NC contact, channel 2 on M12 socket, right

Slow-action contacts	1 NC	24 V DC	⊕ B	3SF1 124-1KA00-1BA2	1	1 unit	121
Snap-action contacts	1 NC	24 V DC	⊕ B	3SF1 124-1LA00-1BA2	1	1 unit	121

ASIsafe basic switch

⊕ Positively opening according to IEC 60947-5-1, Appendix K, or positively driven actuator, usable in safety circuits.

Note: For selection aid, see page 9/12.

Version	Plunger or roller diameter	DT	Modular system	PU (UNIT, SET, M)	PS*	PG
			<input type="checkbox"/>			
			Order No.	Price per PU		

Operating mechanisms



Plain plunger

Plain plungers

High-grade steel plungers	10	⊕ A	3SE5 000-0AB01	1	1 unit	102
---------------------------	----	-----	-----------------------	---	--------	-----



Rounded plunger

Rounded plungers, type B, acc. to EN 50041

High-grade steel plungers, with 3 mm overtravel	10	⊕ B	3SE5 000-0AC02	1	1 unit	102
---	----	-----	-----------------------	---	--------	-----









Roller plunger

Roller plungers, type C acc. to EN 50041

High-grade steel roller, with 3 mm overtravel	13	⊕ B	3SE5 000-0AD02	1	1 unit	102
---	----	-----	-----------------------	---	--------	-----

⊕ Positively driven actuator, usable in safety circuits.

Metal enclosures
Enclosure width 40 mm acc. to EN 50041/56 mm

Version	Roller diameter	DT	Modular system	PU (UNIT, SET, M)	PS*	PG	
	mm		Order No.	Price per PU			
Operating mechanisms							
	Roller levers						
	Metal lever, plastic roller	22	⊕ A	3SE5 000-0AE01	1	1 unit 102	
	Metal lever, high-grade steel roller	22	⊕ B	3SE5 000-0AE02	1	1 unit 102	
	High-grade steel lever, plastic roller	22	⊕ B	3SE5 000-0AE03	1	1 unit 102	
	Angular roller levers						
	High-grade steel lever, high-grade steel roller	22	⊕ B	3SE5 000-0AE04	1	1 unit 102	
	Metal lever, plastic roller	22	⊕ A	3SE5 000-0AF01	1	1 unit 102	
	Metal lever, high-grade steel roller	22	⊕ B	3SE5 000-0AF02	1	1 unit 102	
	Twist actuators, metal (without lever)						
	High-grade steel lever, plastic roller	22	⊕ B	3SE5 000-0AF03	1	1 unit 102	
	High-grade steel lever, high-grade steel roller	22	⊕ B	3SE5 000-0AF04	1	1 unit 102	
	• For twist levers, switching right or left, adjustable - For enclosure width 40 and 56 mm		⊕ A	3SE5 000-0AH00	1	1 unit 102	
		⊕ B	3SE5 000-0AT10	1	1 unit 102		
Levers for twist actuators							
	Twist levers 27 mm, offset, type A, acc. to EN 50041						
	Metal lever, plastic roller	19	⊕ A	3SE5 000-0AA01	1	1 unit 102	
	Metal lever, high-grade steel roller	19	⊕ A	3SE5 000-0AA02	1	1 unit 102	
	Metal lever, roller with ball bearing	19	⊕ B	3SE5 000-0AA03	1	1 unit 102	
	Metal lever, 2 plastic rollers	19	⊕ B	3SE5 000-0AA04	1	1 unit 102	
	Metal lever, plastic roller	30	⊕ B	3SE5 000-0AA05	1	1 unit 102	
	Metal lever, plastic roller	50	⊕ B	3SE5 000-0AA07	1	1 unit 102	
	Metal levers, rubber roller	50	⊕ B	3SE5 000-0AA08	1	1 unit 102	
	High-grade steel lever, plastic roller	19	⊕ B	3SE5 000-0AA11	1	1 unit 102	
	High-grade steel lever, high-grade steel roller	19	⊕ B	3SE5 000-0AA12	1	1 unit 102	
		Twist levers 35 mm, offset					
		Metal lever, plastic roller	19	⊕ B	3SE5 000-0AA15	1	1 unit 102
Twist levers 30 mm, straight¹⁾							
	Metal lever, plastic roller	19	⊕ B	3SE5 000-0AA24	1	1 unit 102	
	Metal lever, plastic roller	30	⊕ B	3SE5 000-0AA26	1	1 unit 102	
	Twist levers, adjustable length, with grid hole						
	Metal lever, plastic roller	19	⊕ B	3SE5 000-0AA60	1	1 unit 102	
	Metal lever, high-grade steel roller	19	⊕ B	3SE5 000-0AA61	1	1 unit 102	
	Metal lever, plastic roller	50	⊕ B	3SE5 000-0AA67	1	1 unit 102	
	Metal lever, rubber roller	50	⊕ B	3SE5 000-0AA68	1	1 unit 102	
	High-grade steel lever, plastic roller	19	⊕ B	3SE5 000-0AA62	1	1 unit 102	
	High-grade steel lever, high-grade steel roller	19	⊕ B	3SE5 000-0AA63	1	1 unit 102	
	Fork levers (for switches with snap-action contacts only)						
Metal lever, 2 plastic rollers	19	⊕ B	3SE5 000-0AT01	1	1 unit 102		
Metal lever, 2 high-grade steel rollers	19	⊕ B	3SE5 000-0AT02	1	1 unit 102		
High-grade steel lever, 2 plastic rollers	19	⊕ B	3SE5 000-0AT03	1	1 unit 102		
High-grade steel lever, 2 high-grade steel rollers	19	⊕ B	3SE5 000-0AT04	1	1 unit 102		

⊕ Positively driven actuator, usable in safety circuits.

¹⁾ Can be clinch mounted (turned through 180°, rear of lever).

3SF1 AS-Interface Position Switches

With Separate Actuator

General data

Overview

The 3SF1 position switches with safety-oriented communication can be directly connected using the AS-Interface bus system. The safety functions no longer have to be conventionally wired up.

With the 3SF1 position switches the ASIsafe electronics are integrated in the switch enclosure.



3SF1 position switches with head for separate actuator and with integrated ASIsafe Electronics

3SF1 position switches with separate actuator have the same enclosures as the standard switches.

Operation

The actuator head is included in the scope of supply. For actuation from four directions it can be adjusted through $4 \times 90^\circ$. The switches can also be approached from above.

The actuators are not included in the scope of supply of the position switch and must be ordered separately from a choice of six versions to suit the application.

The actuator is encoded. Simple overruling by hand or auxiliary devices is impossible.

A high-grade steel blocking insert for attaching up to eight padlocks is available for even more safety.

A rubber cap to protect the metal enclosure from contamination is available for operation in dusty environments.

Display

The switches have a status display with three LEDs:

- LED 1 (yellow): F-IN1
- LED 2 (yellow): F-IN2
- LED 3 (green/red): AS-i/FAULT

Connection

Connection to the AS-Interface is by means of a 4-pole M12 connector socket (plastic version) connected to the yellow AS-Interface bus cable.

The wide enclosures (50 or 56 mm) also have an M12 socket for connecting a second position switch. Category 4 according to EN 954-1 is thus achieved.

Benefits

The new generation of 3SF1 position switches with separate actuator offers:

- ASIsafe Electronics integrated in the enclosure, with low power consumption $< 60 \text{ mA}$
- An extensive range of actuators
- Status display with three LEDs

Application

Position switches with separate actuator are used where the position of doors, covers or protective grills must be monitored for safety reasons.

The position switch can only be operated with the matching coded actuator. Simple overruling by hand or auxiliary devices is impossible.

Devices are available with enclosure versions to suit the particular ambient conditions. Different control tasks can be performed with the best contact blocks suited for the particular purpose. Dimensions, fixing points of the enclosure are in accordance with EN 50041 or EN 50047 standards.

The devices are suitable for use in any climate.

Standards

The switches comply with the standards IEC 60947-1 (Low-Voltage Switchgear and Controlgear, General) and IEC 60947-5-1 (Electromechanical Control Circuit Devices).

The mechanical design of the switch corresponds to the requirements of the failsafe principle according to EN 1088.

Approvals

AS-Interface according to EN 50295 and IEC 62026-2.

With a 3SF1 position switch it is possible to achieve Category 3 according to ISO 13849-1 (EN 954-1) or SIL 2 according to IEC 61508.

Category 4 according to ISO 13849-1 (EN 954-1) or SIL 3 according to IEC 61508 can be achieved by using a second 3SE5 position switch.

The 3SF1 position switches are approved according to UL 508, UL 50 and UL 746-C.

3SF1 AS-Interface Position Switches

With Separate Actuator

Molded-plastic enclosures
Enclosure width 31 mm / 50 mm

Overview

- Contacts: 1 or 2 slow-action contacts
- Status display with 3 LEDs 24 V DC;
1: F-IN1, 2: F-IN2, 3: AS-I/FAULT
- Degree of protection IP65 (31 mm) or IP66/IP67 (50 mm)

Selection and ordering data

Version ¹⁾	Contacts	DT	Complete units	PU (UNIT, SET, M)	PS*	PG
			<input type="checkbox"/>			
			Order No.	Price per PU		

Enclosure width 31 mm according to EN 50047



5 directions of approach

With M12 connector socket, 4-pole;
channel 1 on NC contact,
channel 2 on NC contact

Slow-action contacts

2 NC

⊕ B

3SF1 234-1QV40-1BA1

1

1 unit

121

Enclosure width 50 mm



5 directions of approach

With M12 connector socket, 4-pole;
channel 1 on NC,
channel 2 on M12 socket, right

Slow-action contacts

1 NC

⊕ B

3SF1 244-1QV40-1BA2

1

1 unit

121

⊕ Positive opening according to IEC 60947-5-1, Appendix K.

¹⁾ Supplied without actuator. Please order separately.

3SF1 AS-Interface Position Switches



With Separate Actuator

Metal enclosures
Enclosure width 31 mm / 40 mm / 56 mm

Overview

- Contacts: 1 or 2 slow-action contacts
- Status display with 3 LEDs 24 V DC;
1: F-IN1, 2: F-IN2, 3: AS-I/FAULT
- Degree of protection IP66/IP67

Selection and ordering data

Version ¹⁾	Contacts	DT	Complete units	PU (UNIT, SET, M)	PS*	PG
			<input type="checkbox"/>			
			Order No.	Price per PU		
Enclosure width 31 mm according to EN 50047						
	5 directions of approach With M12 connector socket, 4-pole; channel 1 on NC contact, channel 2 on NC contact Slow-action contacts	2 NC	⊕ B	3SF1 214-1QV40-1BA1	1	1 unit 121
Enclosure width 40 mm according to EN 50041						
	5 directions of approach With M12 connector socket, 4-pole; channel 1 on NC contact, channel 2 on NC contact Slow-action contacts	2 NC	⊕ B	3SF1 114-1QV10-1BA1	1	1 unit 121
Enclosure width 56 mm						
	5 directions of approach With M12 connector socket, 4-pole; channel 1 on NC, channel 2 on M12 socket, right Slow-action contacts	1 NC	⊕ B	3SF1 124-1QV10-1BA2	1	1 unit 121

⊕ Positive opening according to IEC 60947-5-1, Appendix K.









¹⁾ Supplied without actuator. Please order separately.

3SF1 AS-Interface Position Switches

With Separate Actuator

Accessories

Overview

Version	DT	Order No.	Price per PU	PU (UNIT, SET, M)	PS*	PG
Actuators						
 3SE5 000-0AV01		Standard actuators • Length 75.6 mm	▶	3SE5 000-0AV01	1	1 unit 102
 3SE5 000-0AV02	A	• With vertical fixing, length 53 mm		3SE5 000-0AV02	1	1 unit 102
 3SE5 000-0AV03	A	• With transverse fixing, length 47 mm		3SE5 000-0AV03	1	1 unit 102
Radius actuators, length 51 mm						
 3SE5 000-0AV04	A	• Direction of approach from the left		3SE5 000-0AV04	1	1 unit 102
 3SE5 000-0AV06	A	• Direction of approach from the right		3SE5 000-0AV06	1	1 unit 102
Universal radius actuators, length 77 mm						
 3SE5 000-0AV05	A			3SE5 000-0AV05	1	1 unit 102
Universal radius actuators, heavy-duty						
 3SE5 000-0AV07	A	• Length 67 mm		3SE5 000-0AV07-1AK2	1	1 unit 102
	A	• Length 77 mm		3SE5 000-0AV07	1	1 unit 102
Optional accessories						
 3SE5 000-0AV08-1AA2	B	Protective caps made of black rubber for the actuator head, to protect the actuator openings from contamination (Only for enclosure width 40 or 56 mm)		3SE5 000-0AV08-1AA2	1	1 unit 102
 3SE5 000-0AV08-1AA3	C	Blocking inserts , high-grade steel, for actuator head, for up to 8 padlocks		3SE5 000-0AV08-1AA3	1	1 unit 102

3SF1 AS-Interface Position Switches

With Interlocking

General data

Overview

The 3SF1 position switches with safety-oriented communication can be directly connected using the AS-Interface bus system. The safety functions no longer have to be conventionally wired up.

With the 3SF1 position switches the ASIsafe electronics are integrated in the switch enclosure.



3SF1 position switch with interlocking and with integrated ASIsafe electronics

Operation

The actuator head is included in the scope of supply. For actuation from four directions it can be adjusted through $4 \times 90^\circ$. The switches can also be approached from above.

The actuators are not included in the scope of supply of the position switch and must be ordered separately from a choice of six versions to suit the application.

The actuator is encoded. Simple overruling by hand or auxiliary devices is impossible.

A high-grade steel blocking insert for attaching up to eight padlocks is available for even more safety.

A rubber cap to protect the enclosure from contamination is available for operation in dusty environments.

Interlocking

There are two versions for locking the actuator:

- Spring-actuated lock (closed-circuit principle) with various release mechanisms
- Solenoid lock (open-circuit principle)

For more explanations see page 9/62.

Display

The switches have a status display with four LEDs:

- LED 1 (green): AS-i
- LED 2 (red): FAULT
- LED 3 (yellow): F-IN1
- LED 4 (yellow): F-IN2

Connection

Connection to the AS-Interface is by means of a 4-pole M12 connector socket (plastic version) connected to the yellow AS-Interface bus cable (no additional supply of auxiliary power is required thanks to the low current consumption of the solenoid of max. 170 mA).

Benefits

The new generation of 3SF1 3 position switches with solenoid interlocking offers:

- More safety through higher locking forces:
 - 1300 N for the plastic version
 - 2600 N for the metal version
- Various release mechanisms: lock release, escape release and emergency release
- ASIsafe Electronics integrated in the enclosure; connected through 4-pole M12 connector socket
- Current consumption of the solenoid max. 170 mA
- Two contact blocks as standard equipment, hence fewer versions needed
- Same dimensions for all enclosure variants: Plastic, metal
- An extensive range of actuators
- Status display with four LEDs

Application

The position switches with interlocking are exceptional safety-related devices which prevent an unforeseen or intentional opening of protective doors, protective grills or other covers as long as a dangerous situation is present (i.e. follow-on motion of the switched off machine).

The safety position switches with interlocking have the following functions:

- Enabling the machine or process with closed and locked protective device
- Locking the machine or process with opened protective device
- Position monitoring of the protective device and solenoid interlocking

Standards

The switches comply with the standards IEC 60947-1 (Low-Voltage Switchgear and Controlgear, General) and IEC 60947-5-1 (Electromechanical Control Circuit Devices).

The mechanical design of the switch corresponds to the requirements of the failsafe principle according to EN 1088.

Approvals

AS-Interface according to EN 50295 and IEC 62026-2.

The switches are approved for use with locking devices according to EN 1088 and EN 292, Parts 1 and 2.

3SE5 3 position switches with interlocking bear the VDE test mark.

With a 3SF1 3 position switch with interlocking it is possible to achieve category 3 according to ISO 13849-1 (EN 954-1) or SIL 2 according to IEC 61508.

Category 4 according to ISO 13849-1 (EN 954-1) or SIL 3 according to IEC 61508 can be achieved by using a second 3SE5 position switch.

The 3SF1 position switches are approved according to UL 508, UL 50 and UL 746-C.

Overview**5 directions of approach - Degree of protection IP66/IP67**

- Slow-action contacts:
 - Version -1BA1: ASIsafe channel 1 on 1 NC contact from the actuator and channel 2 on 1 NC contact from the solenoid¹⁾
 - Version -1BA3: ASIsafe channel 1 on the first NC contact from the actuator and channel 2 on the second NC contact from the actuator
 - Version -1BA4: ASIsafe channel 1 on 2 NC contacts from the actuator and channel 2 on 1 NC contact from the solenoid A discrepancy between the two contacts of the actuator will be evaluated already in the switch.
- Solenoid: Rated operational voltage 24 V DC
- Locking force 1300 N (1000 N according to GS-ET 19)
- Status display with 4 LEDs 24 V DC;
 - 1: AS-i, 2: FAULT, 3: F-IN1, 4: F-IN2

Safety level

The new 3SF1 324-1S.21-1BA4 safety position switches are also recommended in the case of series connections for protective door interlocking where reliable diagnostics and quick restart capability of equipment is required.

They feature:

- Feedback from the solenoid and
- No opening of the doors after the solenoid is unlocked.



With AS-i safety monitor or in DP/AS-i F-Link it is possible to achieve SIL 2 according to IEC 61508 or PL d according to ISO 13849-1.

Comparison of versions

Safety switch	Contacts	Achievable safety level	Diagnostics	Reclose condition
Type	Actuator / magnet		Feedback from the solenoid	After unlocking the solenoid (depending on the type of evaluation)
3SF1 324-1S.21-1BA1	1 NC/1 NC	SIL 1 / PL c	✓	Door does <u>not</u> have to be opened
	1 NC/1 NC	SIL 2 / PL d	✓	Door must be opened
3SF1 324-1S.21-1BA3	2 NC	SIL 2 / PL d	--	Door does <u>not</u> have to be opened
3SF1 324-1S.21-1BA4	2 NC/1 NC	SIL 2 / PL d	✓	Door does <u>not</u> have to be opened

✓ yes
-- no

Selection and ordering data

	Interlock ¹⁾	Contacts Actuators/ Solenoids	DT	Complete units	PU (UNIT, SET, M)	PS*	PG
				Order No.			
1300 N locking force - Enclosure width 54 mm							
	Spring-actuated locks						
	• With auxiliary release	1 NC/1 NC	⊕ B	3SF1 324-1SD21-1BA1	1	1 unit	121
		2 NC/--	⊕ B	3SF1 324-1SD21-1BA3	1	1 unit	121
		2 NC/1 NC	⊕ B	3SF1 324-1SD21-1BA4	1	1 unit	121
	• With auxiliary release with lock	1 NC/1 NC	⊕ B	3SF1 324-1SE21-1BA1	1	1 unit	121
3SF1 324-1SD21-...							
	• With escape release from the front	1 NC/1 NC	⊕ B	3SF1 324-1SF21-1BA1	1	1 unit	121
		2 NC/1 NC	⊕ B	3SF1 324-1SF21-1BA4	1	1 unit	121
		1 NC/1 NC	⊕ B	3SF1 324-1SG21-1BA1	1	1 unit	121
		2 NC/1 NC	⊕ B	3SF1 324-1SG21-1BA4	1	1 unit	121
		1 NC/1 NC	⊕ B	3SF1 324-1SJ21-1BA1	1	1 unit	121
3SF1 324-1SF21-...							
	Solenoid locks						
	1 NC/1 NC	⊕ B	3SF1 324-1SB21-1BA1	1	1 unit	121	
	2 NC/--	⊕ B	3SF1 324-1SB21-1BA3	1	1 unit	121	
3SF1 324-1SB21-...							

⊕ Positive opening according to IEC 60947-5-1, Appendix K.

¹⁾ Supplied without actuator. Please order separately.

For actuators and optional accessories see page 9/93.

3SF1 AS-Interface Position Switches

With Interlocking

Metal enclosures
With locking force greater than 2000 N

Overview

5 directions of approach - Degree of protection IP66/IP67

- Slow-action contacts:
Version -1BA1: ASIsafe channel 1 on 1 NC contact from the actuator and channel 2 on 1 NC contact from the solenoid
- Solenoid: Rated operational voltage 24 V DC
- Locking force 2600 N (2000 N according to GS-ET 19)
- Status display with 4 LEDs 24 V DC;
1: AS-i, 2: FAULT, 3: F-IN1, 4: F-IN2

Safety level

See page 9/95.

Selection and ordering data

Interlock ¹⁾	Contacts Actuators/ Solenoids	DT	Complete units	PU (UNIT, SET, M)	PS*	PG		
			<input type="checkbox"/>					
			Order No.	Price per PU				
2600 N locking force - Enclosure width 54 mm								
	Spring-actuated locks			1	1 unit	121		
	• With auxiliary release	1 NC/1 NC					⊕ B	3SF1 314-1SD11-1BA1
• With auxiliary release with lock	1 NC/1 NC	⊕ B		3SF1 314-1SE11-1BA1				
	• With escape release from the front	1 NC/1 NC		⊕ B	3SF1 314-1SF11-1BA1	1	1 unit	121
	• With escape release from the back and auxiliary release from the front	1 NC/1 NC		⊕ B	3SF1 314-1SG11-1BA1	1	1 unit	121
	• With emergency release from the back and auxiliary release from the front	1 NC/1 NC		⊕ B	3SF1 314-1SJ11-1BA1	1	1 unit	121
	Solenoid locks			1 NC/1 NC	⊕ B	3SF1 314-1SB11-1BA1	1	1 unit

⊕ Positive opening according to IEC 60947-5-1, Appendix K.

¹⁾ Supplied without actuator. Please order separately.

For actuators and optional accessories see page 9/93.

3SF1 AS-Interface Position Switches

Hinge Switches

Molded-plastic enclosures
Enclosure width 31 mm / 50 mm

Overview

The 3SF1 hinge switches with safety-oriented communication can be directly connected using the AS-Interface bus system. The safety functions no longer have to be conventionally wired up.

With the 3SF1 position switches the ASIsafe electronics are integrated in the switch enclosure.

The hinge switches are provided for mounting on hinges. There are two actuator variants here:

- Hollow shaft, inner diameter 8 mm, outer 12 mm
- Solid shaft, diameter 10 mm

For the ASIsafe version of the hinge switch, the basic switch and twist actuator must be ordered separately. The basic switches correspond to the position switches of the standard version (only use versions with snap-action contacts).

The standards and approvals are the same as for the 3SF1 standard switches ([see page 9/82](#)).

Selection and ordering data

Modular system

1 or 2 contacts · 3 LEDs · Degree of protection IP65 (31 mm) or IP66/IP67 (50 mm) · M12 connector socket

Version	Contacts	LEDs	DT	Modular system	PU (UNIT, SET, M)	PS*	PG
				<input checked="" type="checkbox"/>			
				Order No.	Price per PU		

Basic switches · Enclosure width 31 mm according to EN 50047



With teflon plunger, with M12 connector socket, 4-pole, channel 1 on NC contact, channel 2 on NC contact

Snap-action contacts

2 NC

24 V DC



B

3SF1 234-1LC05-1BA1

1

1 unit

121

ASIsafe basic switch

Basic switches · Enclosure width 50 mm



With teflon plunger, with M12 connector socket, 4-pole, channel 1 on NC contact, channel 2 on M12 socket, right

Snap-action contacts

1 NC

24 V DC



B

3SF1 244-1LC05-1BA2

1

1 unit

121

ASIsafe basic switch

Actuator heads



Twist actuator with hollow shaft

With hollow shaft

Operating angle 10°

B

3SE5 000-0AU21

1

1 unit

102



Twist actuator with solid shaft

With solid shaft

Operating angle 10°

B

3SE5 000-0AU22

1

1 unit

102

☞ Positive opening according to IEC 60947-5-1, Appendix K.

3SF1 AS-Interface Position Switches

Hinge Switches

Metal enclosures

Enclosure width 31 mm / 40 mm / 56 mm

Overview

The 3SF1 hinge switches with safety-oriented communication can be directly connected using the AS-Interface bus system. The safety functions no longer have to be conventionally wired up.

With the 3SF1 position switches the ASIsafe electronics are integrated in the switch enclosure.

The hinge switches are provided for mounting on hinges. There are two actuator variants here:

- Hollow shaft, inner diameter 8 mm, outer 12 mm
- Solid shaft, diameter 10 mm





For the ASIsafe version of the hinge switch, the basic switch and twist actuator must be ordered separately. The basic switches correspond to the position switches of the standard version (only use versions with snap-action contacts).

The standards and approvals are the same as for the 3SF1 standard switches ([see page 9/82](#)).

Selection and ordering data

Modular system

1 or 2 contacts · 3 LEDs · Degree of protection IP66/IP67 · M12 connector socket

Version	Contacts	LEDs	DT	Modular system	PU (UNIT, SET, M)	PS*	PG			
				Order No.	Price per PU					
Basic switches - Enclosure width 31 mm according to EN 50047										
	With plunger With M12 connector socket, 4-pole, channel 1 on NC contact, channel 2 on NC contact Snap-action contacts			2 NC	24 V DC	⊕ B	3SF1 214-1LC05-1BA1	1	1 unit	121
ASIsafe basic switch										
Basic switches - Enclosure width 40 mm according to EN 50041										
	With M12 connector socket , 4-pole, channel 1 on NC contact, channel 2 on NC contact Snap-action contacts			2 NC	24 V DC	⊕ B	3SF1 114-1LA00-1BA1	1	1 unit	121
ASIsafe basic switch										
Basic switches - Enclosure width 56 mm										
	With M12 connector socket , 4-pole, channel 1 on NC contact, channel 2 on M12 socket, right Snap-action contacts			1 NC	24 V DC	⊕ B	3SF1 124-1LA00-1BA2	1	1 unit	121
ASIsafe basic switch										
Actuator heads										
	Hollow shaft Operating angle 10°					B	3SE5 000-0AU21	1	1 unit	102
Twist actuator with hollow shaft										
	Solid shaft Operating angle 10°					B	3SE5 000-0AU22	1	1 unit	102
Twist actuator with solid shaft										

⊕ Positive opening according to IEC 60947-5-1, Appendix K.

Overview



Switching magnets and contact blocks

A magnetically operated switch is comprised of a coded switching magnet and a switching element (sensor unit). Evaluation requires a safety relay or connection to a bus system.

3SE6 806 safety relays

Up to six protective devices (sensors) can be connected to the safety relay.

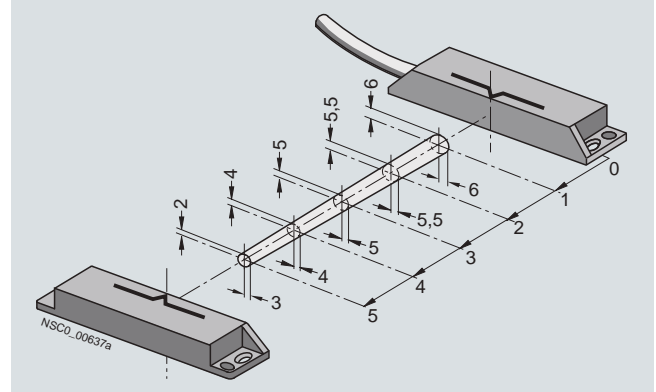

Enabling range (example)

The device has six current-sourcing semiconductor outputs (Y1 ... Y6) which signal the state of the connected protective devices.

The 3SE6 806 safety relay has two floating enabling circuits (safe circuits) as NO contact circuits and one floating signaling circuit as a NC circuit. The number of enabling circuits can be increased by adding one or more 3TK28 30 expansion modules.

Application

SIRIUS 3SE6 magnetically operated switches are designed for mounting on movable protective guards (hoods, hinge switches, doors, etc.). Evaluation can be performed by means of a safety relay or through connection to a bus system.

The 3SE6 6 non-contact, magnetically operated safety switches stand out due to their enclosed design with degree of protection IP67. They are particularly suitable therefore for areas exposed to contamination, cleaning or disinfecting.

A magnetic monitoring system comprises one or more magnetically operated switches and an evaluation unit, e.g. a safety relay. When contact blocks 1 NO + 1 NC are used the 3SE6 806 safety relay provides a high degree of protection against manipulation and can be installed in safety circuits up to Category 3 according to ISO 13849-1 (EN 954-1).

Combination of monitoring units and magnetically operated switches

Monitoring units		Magnetically operated switches (contact block + switching magnet)				Achievable category (EN 954-1)/ Performance level (EN ISO 13849-1)
		1 NC + 1 NO		2 NC		
		3SE6 605-1BA	3SE6 605-2BA	3SE6 605-3BA	3SE6 604-2BA	
		3SE6 704-1BA	3SE6 704-2BA	3SE6 704-3BA	3SE6 704-2BA	
Relay outputs						
SIRIUS safety relays, 6-fold	3SE6 806-2CD00	✓	✓	✓	--	Cat. 3
SIRIUS safety relays	3TK28 26	✓	✓	✓	✓	Cat. 4/e
Solid-state outputs						
SIRIUS safety relays	3TK28 40	--	--	--	✓	Cat. 3/d
	3TK28 41, 3TK28 42, 3TK28 45	--	--	--	✓	Cat. 4/e
SIRIUS safety relays with contactor relay	3TK28 50, 3TK28 51, 3TK28 52	--	--	--	✓	Cat. 3/d
	3TK28 53	--	--	--	✓	Cat. 4/e
ASIsafe compact safety modules	3RK1 205, 3RK1 405	--	--	--	✓	Cat. 4
SIMATIC S7-31xF-2 DP or SIMATIC ET 200M	SM 326 F, 24 DI, 24 V DC SM 326 F, 8 DI, NAMUR	✓	✓	✓	✓	Cat. 4
SIMATIC ET 200S PROFIsafe	4/8 F-DI / 3 F-DO, 24 V DC	✓	✓	✓	✓	Cat. 3
	4/8 F DI, 24 V DC	✓	✓	✓	✓	Cat. 4
SIMATIC ET 200eco	4/8 F DI, 24 V DC	✓	✓	✓	✓	Cat. 4
SIMATIC ET 200pro	8/16 F-DI, 24 V DC, 4/8 F-DI / 4 F-DO 2 A, 24 V DC, F-Switch	✓	✓	✓	✓	Cat. 4
Modular Safety System	3RK3	✓	✓	✓	✓	Cat. 4/e

✓ Suitable magnetically operated switch

3SE6 Magnetically Operated Switches

Magnetic monitoring systems

Selection and ordering data

Version	Size	Contacts	DT	Order No.	Price per PU	PU (UNIT, SET, M)	PS*	PG									
mm																	
Round sensor units																	
	Switching magnets (coded)	M30	A	3SE6 704-1BA		1	1 unit	102									
	Contact blocks	M30	1 NO + 1 NC A	3SE6 605-1BA		1	1 unit	102									
	• With cable, 3 m	M30	1 NO + 1 NC C	3SE6 605-1BA02		1	1 unit	102									
	• With M12 plug, 4-pole	M30	1 NO + 1 NC C	3SE6 605-1BA02		1	1 unit	102									
Rectangular sensor units																	
	Switching magnets (coded)	25 × 88	A	3SE6 704-2BA		1	1 unit	102									
	Contact blocks	25 × 88	1 NO + 1 NC A	3SE6 605-2BA		1	1 unit	102									
	• With cable, 3 m	25 × 88	2 NC A	3SE6 604-2BA		1	1 unit	102									
	• With M8 plug, 4-pole	25 × 88	1 NO + 1 NC C	3SE6 605-2BA01		1	1 unit	102									
		25 × 88	2 NC C	3SE6 604-2BA01		1	1 unit	102									
	Switching magnets (coded)	25 × 33	A	3SE6 704-3BA		1	1 unit	102									
	Contact blocks with cable, 3 m	25 × 33	1 NO + 1 NC A	3SE6 605-3BA		1	1 unit	102									
Accessories																	
	Spacers	25 × 88	D	3SX3 260		1	1 unit	102									
	Spacers	25 × 33	D	3SX3 261		1	1 unit	102									
<table border="1"> <thead> <tr> <th>Version</th> <th>Number of sensors</th> <th>Enabling/signaling circuits</th> <th>DT</th> <th>Order No.</th> <th>Price per PU</th> <th>PU (UNIT, SET, M)</th> <th>PS*</th> <th>PG</th> </tr> </thead> </table>									Version	Number of sensors	Enabling/signaling circuits	DT	Order No.	Price per PU	PU (UNIT, SET, M)	PS*	PG
Version	Number of sensors	Enabling/signaling circuits	DT	Order No.	Price per PU	PU (UNIT, SET, M)	PS*	PG									
Monitoring units																	
	Safety relays with relay output, 6-fold	6	2 NO / 1 NC B	3SE6 806-2CD00		1	1 unit	102									
	Rated control supply voltage 24 V DC																

For more monitoring units, see Chapter 8 "Monitoring and Control Devices" and Catalog IK PI.