

Selection diagram

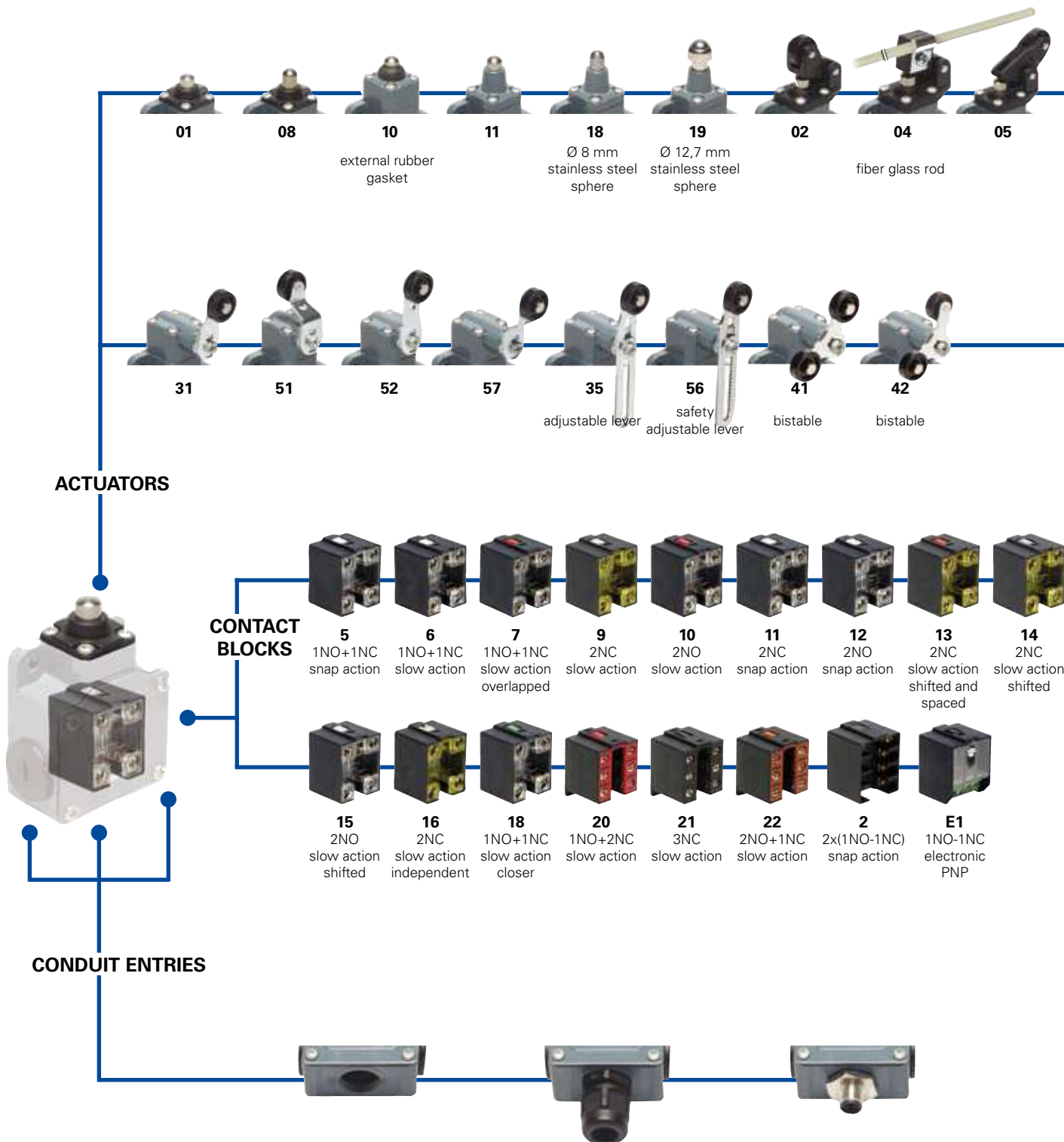

Threaded conduit entries

	PG 13,5 (standard)
M2	M20x1,5

With assembled cable gland

PG 13,5	K21	for Ø 6 to Ø 12 mm cables range, from bottom
	K121	for Ø 6 to Ø 12 mm cables range, from right
	K221	for Ø 6 to Ø 12 mm cables range, from left
	K25	for Ø 3 to Ø 7 mm cables range, from bottom
	K125	for Ø 3 to Ø 7 mm cables range, from right
M20x1,5	K225	for Ø 3 to Ø 7 mm cables range, from left
	K23	for Ø 6 to Ø 12 mm cables range, from bottom
	K123	for Ø 6 to Ø 12 mm cables range, from right
	K223	for Ø 6 to Ø 12 mm cables range, from left
	K27	for Ø 3 to Ø 7 mm cables range, from bottom
	K127	for Ø 3 to Ø 7 mm cables range, from right
	K227	for Ø 3 to Ø 7 mm cables range, from left

With M12 metal connector assembled and wired

K40	8 poles from bottom
K41	8 poles from right
K42	8 poles from left
K50	5 poles from bottom
K51	5 poles from right
K52	5 poles from left

● product option
 → accessory sold separately

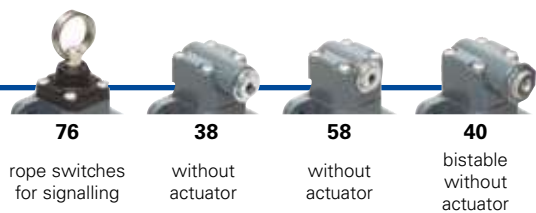
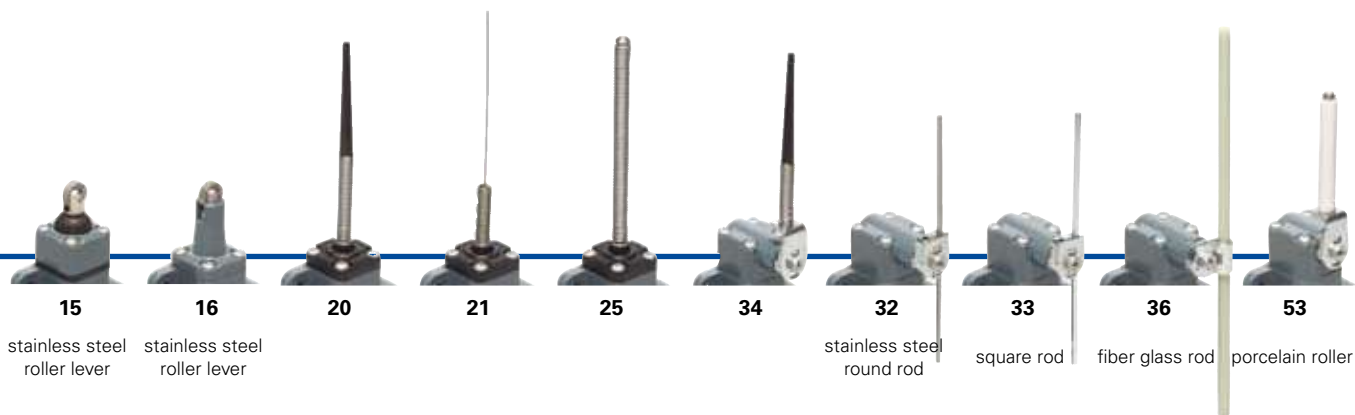

LOOSE ACTUATORS
See page 2/31



Code structure

Attention! The feasibility of a code number does not mean the effective availability of a product. Please contact our sales office.

article options
FL 502-1GM2K50

Housing	
FL	metal housing, three conduit entries
Contact blocks	
5	1NO+1NC, snap action
6	1NO+1NC, slow action
7	1NO+1NC, slow action overlapped
...
Actuators	
01	short plunger
02	roller lever
05	offset roller lever
...
Suffix	
	no suffix (standard)
1	with Ø 20 mm stainless steel roller for actuators 02, 05, 31, 35, 51, 52, 56, 57, 41, 42
2	with Ø 35 mm polymer roller (see special loose actuators on page 2/32)
3	with Ø 50 mm rubber roller (see special loose actuators on page 2/32)
4	with Ø 50 mm overhanging rubber roller (see special loose actuators on page 2/32)

Preinstalled cable gland or connectors	
	no cable gland or connector (standard)
K21	with assembled cable gland suitable for Ø 6 to Ø 12 mm cables range
...
K50	with 5 poles M12 metal connector
...

For the complete list of all combinations, please contact our technical office.

Threaded conduit entries	
	PG 13,5 (standard)
M2	M20x1,5

Contacts type	
	silver contacts (standard)
G	silver contacts gold plated 1 µm (contact block 2 excluded)



Main data

- Metal housing, three conduit entries
- Protection degree IP67
- 17 contact blocks available
- 28 actuators available
- M12 assembled connector versions
- Silver contacts gold plated versions

Technical data

Housing

Metal housing, coated with baked epoxy powder

Three conduit entries

Protection degree: IP67 according to EN 60529

General data

Ambient temperature: from -25°C to +80°C

Version for operation in ambient temperature from -40°C to +80°C on request

Max actuation frequency: 3600 operations cycles¹/hour

Mechanical endurance: 20 million operations cycles¹

Assembling position: any

Driving torque for installation: see pages 7/1-7/10

(1) One operation cycle means two movements, one to close and one to open contacts, as foreseen by EN 60947-5-1 standard.

Cross section of the conductors (flexible copper wire)

Contact blocks 20, 21, 22, 33, 34:	min.	1 x 0,34 mm ²	(1 x AWG 22)
	max.	2 x 1,5 mm ²	(2 x AWG 16)
Contact blocks 5, 6, 7, 9, 10, 11, 12, 13, 14, 15, 16, 18:	min.	1 x 0,5 mm ²	(1 x AWG 20)
	max.	2 x 2,5 mm ²	(2 x AWG 14)
Contact block 2:	min.	1 x 0,5 mm ²	(1 x AWG 20)
	max.	2 x 1,5 mm ²	(2 x AWG 16)

In conformity with standards:

IEC 60947-5-1, EN 60947-5-1, EN 60947-1, IEC 60204-1, EN 60204-1, EN 1088, EN ISO 12100-1, EN ISO 12100-2, IEC 60529, EN 60529, NFC 63-140, VDE 0660-200, VDE 0113.

Approvals:

IEC 60947-5-1, UL 508, GB14048.5-2001.

Markings and quality marks:



Approval IMQ: EG605
 Approval UL: E131787
 Approval CCC: 2007010305230000
 Approval EZU: 1010151

In conformity with requirements requested by:

Low Voltage Directive 2006/95/EC, Machinery Directive 2006/42/EC and Electromagnetic Compatibility 2004/108/EC.

Positive contact opening in conformity with standards:

IEC 60947-5-1, EN 60947-5-1, VDE 0660-206.

Installation for safety applications:

Use only switches marked with the symbol ⊕. The safety circuit must always be connected with the **NC contacts** (normally closed contacts: 11-12, 21-22 or 31-32) as stated in the **standard EN 60947-5-1, encl. K, par. 2**. The switch must be actuated with **at least up to the positive opening travel** shown in the travels diagrams on page 7/4. The switch must be actuated **at least with the positive opening force**, shown in brackets, underneath each article, near the value of the min. force.

⚠ **If not expressly indicated in this chapter, for the right installation and the correct utilization of all articles see requirements indicated from page 7/1 to page 7/10.**

Electrical data

Utilization categories

without connector	Thermal current (I _{th}):	10 A	Alternate current: AC15 (50...60 Hz)			
	Rated insulation voltage (U _i):	500 Vac 600 Vdc	U _e (V)	250	400	500
		400Vac500Vdc(contact blocks 2, 11, 12, 20, 21, 22, 33, 34)	I _e (A)	6	4	1
	Rated impulse withstand voltage (U _{imp}):	6 kV 4 kV (contact blocks 20, 21, 22, 33, 34)	Direct current: DC13			
	Conditional short circuit current:	1000 A according to EN 60947-5-1	U _e (V)	24	125	250
	Protection against short circuits:	fuse 10 A 500 V type aM	I _e (A)	6	1,1	0,4
	Pollution degree:	3				

with 5 poles M12 connector	Thermal current (I _{th}):	4 A	Alternate current: AC15 (50...60 Hz)			
	Rated insulation voltage (U _i):	250 Vac 300 Vdc	U _e (V)	24	120	250
	Protection against short circuits:	fuse 4 A 500 V type gG	I _e (A)	4	4	4
	Pollution degree:	3	Direct current: DC13			
			U _e (V)	24	125	250
			I _e (A)	4	1,1	0,4

with 8 poles M12 connector	Thermal current (I _{th}):	2 A	Alternate current: AC15 (50...60 Hz)			
	Rated insulation voltage (U _i):	30 Vac 36 Vdc	U _e (V)	24		
	Protection against short circuits:	fuse 2 A 500 V type gG	I _e (A)	2		
	Pollution degree:	3	Direct current: DC13			
			U _e (V)	24		
			I _e (A)	2		



Data type approved by IMQ, CCC and EZU

Rated insulation voltage (Ui): 500 Vac
400 Vac (for contact blocks 2, 11, 12, 20, 21, 22, 33, 34)

Thermal current (Ith): 10 A

Protection against short circuits: fuse 10 A 500 V type aM

Rated impulse withstand voltage (U_{imp}): 6 kV
4 kV (for contact blocks 20, 21, 22, 33, 34)

Protection degree: IP67

MV terminals (screw clamps)

Pollution degree 3

Utilization category: AC15

Operation voltage (Ue): 400 Vac (50 Hz)

Operation current (Ie): 3 A

Forms of the contact element: Za, Zb, Za+Za, Y+Y, X+X, Y+Y+X, Y+Y+Y, Y+X+X

Positive opening of contacts on contact block 5, 6, 7, 9, 11, 13, 14, 16, 18, 20, 21, 22, 33, 34

In conformity with standards: EN 60947-1, EN 60947-5-1 + A1:2009, fundamental requirements of the Low Voltage Directive 2006/95/CE.

Please contact our technical service for the list of approved products.

Data type approved by UL

Utilization categories Q300 (69 VA, 125-250 Vdc)
A600 (720 VA, 120-600 Vac)

Data of the housing type 1, 4X "indoor use only", 12, 13

For all contact blocks except 2 and 3 use 60 or 75 °C copper (Cu) conductor and wire size No. 12-14 AWG. Terminal tightening torque of 7,1 lb in (0,8 Nm).
For contact blocks 2 and 3 use 60 or 75 °C copper (Cu) conductor and wire size No. 14 AWG. Terminal tightening torque of 12 lb in (1,4 Nm).

In conformity with standard: UL 508

Please contact our technical service for the list of approved products.

Adjustable levers

In switches with revolving lever it is possible to adjust the lever with 10° steps for the whole 360° range. The positive movement

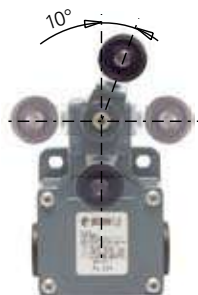

transmission is always guaranteed thanks to the particular geometrical coupling between the lever and the revolving shaft as prescribed for safety applications by the German standard BG-GS-ET-15.

Overturning levers

It's possible to fasten the lever on switches on straight or reverse side, maintaining the positive coupling.

In this way it is possible to obtain two different work plans of the lever.



Rotating heads

In all switches, it is possible to rotate the head in 90° steps.



Working operation of contact block 16 with independent contacts

The contact block 16 has two NC contacts, both with positive opening activated independently according to the lever turning direction.

Lever turned to left

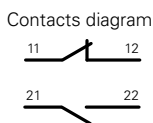

Lever not turned

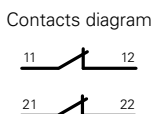

Lever turned to right

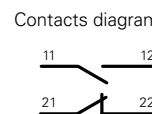

Unidirectional heads

In the switches with revolving lever, it is possible to select the directional operation by removing the four screws of the head and revolving the internal piston (contact block 16 excluded).

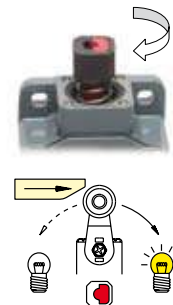
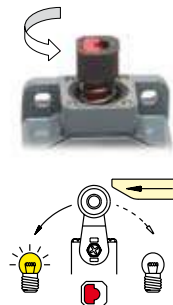
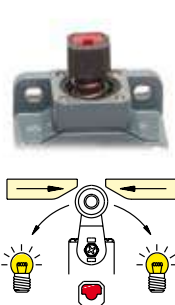

Contacts type:

- R** = snap action
- L** = slow action
- LO** = slow action overlapped
- LS** = slow action shifted
- LV** = slow action shifted and spaced
- LI** = slow action independent
- LA** = slow action closer
-  = electronic PNP

Contact blocks

		With stainless steel roller on request	With stainless steel roller on request	With stainless steel roller on request
5	R FL 501	1NO+1NC	FL 502	1NO+1NC
6	L FL 601	1NO+1NC	FL 602	1NO+1NC
7	LO FL 701	1NO+1NC	FL 702	1NO+1NC
9	L FL 901	2NC	FL 902	2NC
10	L FL 1001	2NO	FL 1002	2NO
11	R FL 1101	2NC	FL 1102	2NC
12	R FL 1201	2NO	FL 1202	2NO
13	LV FL 1301	2NC	FL 1302	2NC
14	LS FL 1401	2NC	FL 1402	2NC
15	LS FL 1501	2NO	FL 1502	2NO
18	LA FL 1801	1NO+1NC	FL 1802	1NO+1NC
20	L FL 2001	1NO+2NC	FL 2002	1NO+2NC
21	L FL 2101	3NC	FL 2102	3NC
22	L FL 2201	2NO+1NC	FL 2202	2NO+1NC
2	R FL 201	2x(1NO-1NC)	FL 202	2x(1NO-1NC)
E1	 FL E101	1NO-1NC	FL E102	1NO-1NC
Max speed	page 7/3 - type 4	page 7/3 - type 3	0,5 m/s	page 7/3 - type 3
Min. force	8 N (25 N \ominus)	6 N (25 N \ominus)	0,17 Nm	6 N (25 N \ominus)
Travel diagrams	page 7/4 - group 1	page 7/4 - group 2	page 7/4 - group 1	page 7/4 - group 2

		With external rubber gasket	With external rubber gasket	With external rubber gasket
5	R FL 508	1NO+1NC	FL 510	1NO+1NC
6	L FL 608	1NO+1NC	FL 610	1NO+1NC
7	LO FL 708	1NO+1NC	FL 710	1NO+1NC
9	L FL 908	2NC	FL 910	2NC
10	L FL 1008	2NO	FL 1010	2NO
11	R FL 1108	2NC	FL 1110	2NC
12	R FL 1208	2NO	FL 1210	2NO
13	LV FL 1308	2NC	FL 1310	2NC
14	LS FL 1408	2NC	FL 1410	2NC
15	LS FL 1508	2NO	FL 1510	2NO
18	LA FL 1808	1NO+1NC	FL 1810	1NO+1NC
20	L FL 2008	1NO+2NC	FL 2010	1NO+2NC
21	L FL 2108	3NC	FL 2110	3NC
22	L FL 2208	2NO+1NC	FL 2210	2NO+1NC
2	R FL 208	2x(1NO-1NC)	FL 210	2x(1NO-1NC)
E1	 FL E108	1NO-1NC	FL E110	1NO-1NC
Max speed	page 7/3 - type 4	page 7/3 - type 4	page 7/3 - type 4	page 7/3 - type 2
Min. force	8 N (25 N \ominus)	11 N (25 N \ominus)	8 N (25 N \ominus)	11 N (25 N \ominus)
Travel diagrams	page 7/4 - group 1	page 7/4 - group 1	page 7/4 - group 1	page 7/4 - group 1

Accessories See page 6/1

All measures in the drawings are in mm



- Contacts type:
- R** = snap action
 - L** = slow action
 - LO** = slow action overlapped
 - LS** = slow action shifted
 - LV** = slow action shifted and spaced
 - LI** = slow action independent
 - LA** = slow action closer
 - ⚡** = electronic PNP

Contact blocks

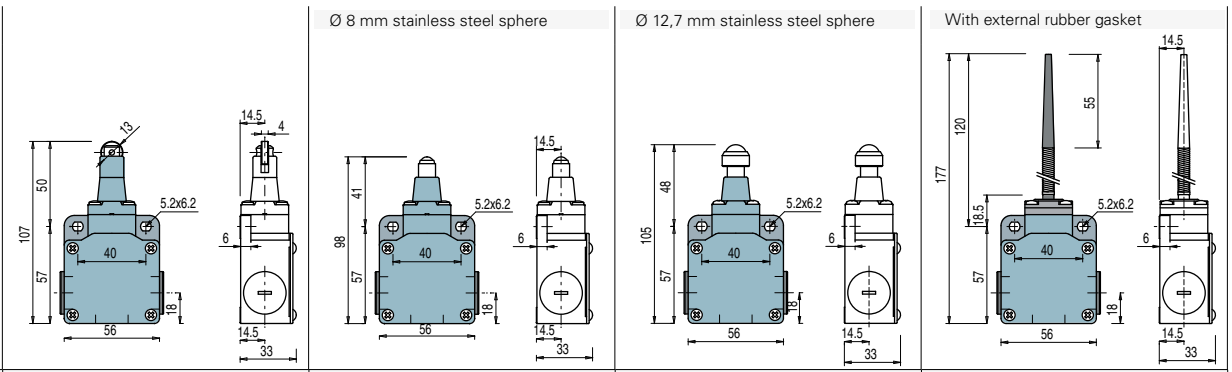

5	R	FL 516	➔ 1NO+1NC	FL 518	➔ 1NO+1NC	FL 519	➔ 1NO+1NC	FL 520	1NO+1NC
6	L	FL 616	➔ 1NO+1NC	FL 618	➔ 1NO+1NC	FL 619	➔ 1NO+1NC		
7	LO	FL 716	➔ 1NO+1NC	FL 718	➔ 1NO+1NC	FL 719	➔ 1NO+1NC		
9	L	FL 916	➔ 2NC	FL 918	➔ 2NC	FL 919	➔ 2NC		
10	L	FL 1016	2NO	FL 1018	2NO	FL 1019	2NO	FL 1020	2NO
11	R	FL 1116	➔ 2NC	FL 1118	➔ 2NC	FL 1119	➔ 2NC		
12	R	FL 1216	2NO	FL 1218	2NO	FL 1219	2NO		
13	LV	FL 1316	➔ 2NC	FL 1318	➔ 2NC	FL 1319	➔ 2NC		
14	LS	FL 1416	➔ 2NC	FL 1418	➔ 2NC	FL 1419	➔ 2NC		
15	LS	FL 1516	2NO	FL 1518	2NO	FL 1519	2NO		
18	LA	FL 1816	➔ 1S+1Ö	FL 1818	➔ 1S+1Ö	FL 1819	➔ 1S+1Ö	FL 1820	1NO+1NC
20	L	FL 2016	➔ 1NO+2NC	FL 2018	➔ 1NO+2NC	FL 2019	➔ 1NO+2NC	FL 2020	1NO+2NC
21	L	FL 2116	➔ 3NC	FL 2118	➔ 3NC	FL 2119	➔ 3NC	FL 2120	3NC
22	L	FL 2216	➔ 2NO+1NC	FL 2218	➔ 2NO+1NC	FL 2219	➔ 2NO+1NC	FL 2220	2NO+1NC
2	R	FL 216	2x(1NO-1NC)	FL 218	2x(1NO-1NC)	FL 219	2x(1NO-1NC)	FL 220	2x(1NO-1NC)
E1	⚡	FL E116	1NO-1NC	FL E118	1NO-1NC	FL E119	1NO-1NC	FL E120	1NO-1NC
Max speed		page 7/3 - type 2		page 7/3 - type 4		page 7/3 - type 4		1 m/s	
Min. force		8 N (25 N ➔)		8 N (25 N ➔)		8 N (25 N ➔)		0,09 Nm	
Travel diagrams		page 7/4 - group 1		page 7/4 - group 1		page 7/4 - group 1		page 7/4 - group 3	

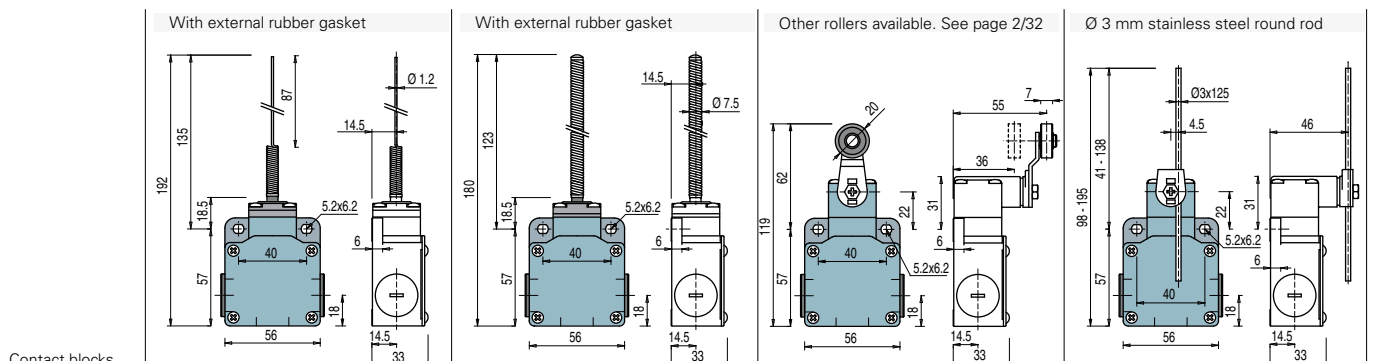

Contact blocks















5	R	FL 521	1NO+1NC	FL 525	1NO+1NC	FL 531	➔ 1NO+1NC	FL 532	1NO+1NC
6	L					FL 631	➔ 1NO+1NC	FL 632	1NO+1NC
7	LO					FL 731	➔ 1NO+1NC	FL 732	1NO+1NC
9	L					FL 931	➔ 2NC	FL 932	2NC
10	L	FL 1021	2NO	FL 1025	2NO	FL 1031	2NO	FL 1032	2NO
11	R					FL 1131	➔ 2NC	FL 1132	2NC
12	R					FL 1231	2NO	FL 1232	2NO
13	LV					FL 1331	➔ 2NC	FL 1332	2NC
14	LS					FL 1431	➔ 2NC	FL 1432	2NC
15	LS					FL 1531	2NO	FL 1532	2NO
16	LI					FL 1631	➔ 2NC	FL 1632	2NC
18	LA	FL 1821	1NO+1NC	FL 1825	1NO+1NC	FL 1831	➔ 1NO+1NC	FL 1832	1S+1Ö
20	L	FL 2021	1NO+2NC	FL 2025	1NO+2NC	FL 2031	➔ 1NO+2NC	FL 2032	1NO+2NC
21	L	FL 2121	3NC	FL 2125	3NC	FL 2131	➔ 3NC	FL 2132	3NC
22	L	FL 2221	2NO+1NC	FL 2225	2NO+1NC	FL 2231	➔ 2NO+1NC	FL 2232	2NO+1NC
2	R	FL 221	2x(1NO-1NC)	FL 225	2x(1NO-1NC)	FL 231	2x(1NO-1NC)	FL 232	2x(1NO-1NC)
E1	⚡	FL E121	1NO-1NC	FL E125	1NO-1NC	FL E131	1NO-1NC	FL E132	1NO-1NC
Max speed		1 m/s		1 m/s		page 7/3 - type 1		1,5 m/s	
Min. force		0,08 Nm		0,14 Nm		0,1 Nm (0,25 Nm ➔)		0,1 Nm	
Travel diagrams		page 7/4 - group 3		page 7/4 - group 3		page 7/4 - group 4		page 7/4 - group 4	







































Items with code on the green background are available in stock

Contacts type:

- R** = snap action
- L** = slow action
- LO** = slow action overlapped
- LS** = slow action shifted
- LV** = slow action shifted and spaced
- LI** = slow action independent
- LA** = slow action closer
-  = electronic PNP

Contact blocks

	3x3 mm square rod		Other rollers available. See page 2/32		Fiber glass rod			
5	R FL 533	1NO+1NC	FL 534	1NO+1NC	FL 535  ⁽¹⁾ 1NO+1NC	FL 536	1NO+1NC	
6	L FL 633	1NO+1NC	FL 634	1NO+1NC	FL 635  ⁽¹⁾ 1NO+1NC	FL 636	1NO+1NC	
7	LO FL 733	1NO+1NC	FL 734	1NO+1NC	FL 735  ⁽¹⁾ 1NO+1NC	FL 736	1NO+1NC	
9	L FL 933	2NC	FL 934	2NC	FL 935  ⁽¹⁾ 2NC	FL 936	2NC	
10	L FL 1033	2NO	FL 1034	2NO	FL 1035	2NO	FL 1036	2NO
11	R FL 1133	2NC	FL 1134	2NC	FL 1135  ⁽¹⁾ 2NC	FL 1136	2NC	
12	R FL 1233	2NO	FL 1234	2NO	FL 1235	2NO	FL 1236	2NO
13	LV FL 1333	2NC	FL 1334	2NC	FL 1335  ⁽¹⁾ 2NC	FL 1336	2NC	
14	LS FL 1433	2NC	FL 1434	2NC	FL 1435  ⁽¹⁾ 2NC	FL 1436	2NC	
15	LS FL 1533	2NO	FL 1534	2NO	FL 1535	2NO	FL 1536	2NO
16	LI FL 1633	2NC	FL 1634	2NC	FL 1635  ⁽¹⁾ 2NC	FL 1636	2NC	
18	LA FL 1833	1S+1Ö	FL 1834	1S+1Ö	FL 1835  ⁽¹⁾ 1S+1Ö	FL 1836	1S+1Ö	
20	L FL 2033	1NO+2NC	FL 2034	1NO+2NC	FL 2035  ⁽¹⁾ 1NO+2NC	FL 2036	1NO+2NC	
21	L FL 2133	3NC	FL 2134	3NC	FL 2135  ⁽¹⁾ 3NC	FL 2136	3NC	
22	L FL 2233	2NO+1NC	FL 2234	2NO+1NC	FL 2235  ⁽¹⁾ 2NO+1NC	FL 2236	2NO+1NC	
2	R FL 233	2x(1NO-1NC)	FL 234	2x(1NO-1NC)	FL 235	2x(1NO-1NC)	FL 236	2x(1NO-1NC)
E1	 FL E133	1NO-1NC	FL E134	1NO-1NC	FL E135	1NO-1NC	FL E136	1NO-1NC
Max speed	1,5 m/s		1 m/s		page 7/3 - type 1		1,5 m/s	
Min. force	0,1 Nm		0,1 Nm		0,1 Nm (0,25 Nm )		0,1 Nm	
Travel diagrams	page 7/4 - group 4		page 7/4 - group 4		page 7/4 - group 4		page 7/4 - group 4	

	Other rollers available. See page 2/32		Other rollers available. See page 2/32		Porcelain roller		Other rollers available. See page 2/32				
5	R FL 551  ⁽¹⁾ 1NO+1NC	FL 552  ⁽¹⁾ 1NO+1NC	FL 553-E11V9  ⁽¹⁾ 1NO+1NC	FL 556  ⁽¹⁾ 1NO+1NC	FL 651  ⁽¹⁾ 1NO+1NC	FL 652  ⁽¹⁾ 1NO+1NC	FL 653-E11V9  ⁽¹⁾ 1NO+1NC	FL 656  ⁽¹⁾ 1NO+1NC			
6	L FL 651  ⁽¹⁾ 1NO+1NC	FL 751  ⁽¹⁾ 1NO+1NC	FL 752  ⁽¹⁾ 1NO+1NC	FL 756  ⁽¹⁾ 1NO+1NC	FL 951  ⁽¹⁾ 2NC	FL 952  ⁽¹⁾ 2NC	FL 953-E11V9  ⁽¹⁾ 2NC	FL 956  ⁽¹⁾ 2NC			
7	LO FL 751  ⁽¹⁾ 1NO+1NC	FL 1051	2NO	FL 1056	2NO	FL 1052	2NO	FL 1056	2NO		
9	L FL 951  ⁽¹⁾ 2NC	FL 1151  ⁽¹⁾ 2NC	FL 1152  ⁽¹⁾ 2NC	FL 1156  ⁽¹⁾ 2NC	FL 1251	2NO	FL 1253-E11V9	2NO	FL 1256	2NO	
10	L FL 1051	2NO	FL 1252	2NO	FL 1351  ⁽¹⁾ 2NC	FL 1352  ⁽¹⁾ 2NC	FL 1353-E11V9  ⁽¹⁾ 2NC	FL 1356  ⁽¹⁾ 2NC	FL 1356	2NC	
11	R FL 1151  ⁽¹⁾ 2NC	FL 1451  ⁽¹⁾ 2NC	FL 1452  ⁽¹⁾ 2NC	FL 1456  ⁽¹⁾ 2NC	FL 1551	2NO	FL 1553-E11V9	2NO	FL 1556	2NO	
12	R FL 1251	2NO	FL 1552	2NO	FL 1651  ⁽¹⁾ 2NC	FL 1652  ⁽¹⁾ 2NC	FL 1653-E11V9	2NO	FL 1656	2NC	
13	LV FL 1351  ⁽¹⁾ 2NC	FL 1851  ⁽¹⁾ 1NO+1NC	FL 1852  ⁽¹⁾ 1S+1Ö	FL 1853-E11V9 ⁽¹⁾ 1S+1Ö	FL 1856 ⁽¹⁾ 1S+1Ö	FL 2051 ⁽¹⁾ 1NO+2NC	FL 2052 ⁽¹⁾ 1NO+2NC	FL 2053-E11V9 ⁽¹⁾ 1NO+2NC	FL 2056 ⁽¹⁾ 1NO+2NC		
14	LS FL 1451 ⁽¹⁾ 2NC	FL 2051 ⁽¹⁾ 1NO+2NC	FL 2052 ⁽¹⁾ 1NO+2NC	FL 2056 ⁽¹⁾ 1NO+2NC	FL 2151 ⁽¹⁾ 3NC	FL 2152 ⁽¹⁾ 3NC	FL 2153-E11V9 ⁽¹⁾ 3NC	FL 2156 ⁽¹⁾ 3NC	FL 2156	3NC	
15	LS FL 1551	2NO	FL 2251 ⁽¹⁾ 2NO+1NC	FL 2252 ⁽¹⁾ 2NO+1NC	FL 2253-E11V9 ⁽¹⁾ 2NO+1NC	FL 2256 ⁽¹⁾ 2NO+1NC	FL 2256	2NO+1NC	FL 2256	2NO+1NC	
16	LI	FL 251	2x(1NO-1NC)	FL 252	2x(1NO-1NC)	FL 253-E11	2x(1NO-1NC)	FL 256	2x(1NO-1NC)	FL 256	2x(1NO-1NC)
18	LA FL 1851 ⁽¹⁾ 1NO+1NC	FL E151	1NO-1NC	FL E152	1NO-1NC	FL E153-E11V9	1NO-1NC	FL E156	1NO-1NC	FL E156	1NO-1NC
20	L FL 2051 ⁽¹⁾ 1NO+2NC	FL E152	1NO-1NC	FL E153-E11V9	1NO-1NC	FL E156	1NO-1NC	FL E156	1NO-1NC	FL E156	1NO-1NC
21	L FL 2151 ⁽¹⁾ 3NC	Max speed	page 7/3 - type 1		0,5 m/s		page 7/3 - type 1				
22	L FL 2251 ⁽¹⁾ 2NO+1NC	Min. force	0,06 Nm (0,25 Nm )		0,03 Nm (0,25 Nm )		0,1 Nm (0,25 Nm )				
2	R FL 251	Travel diagrams	page 7/4 - group 4		page 7/4 - group 4		page 7/4 - group 5				
E1	 FL E151										

Accessories See page 6/1

⁽¹⁾ Positive opening only with lever adjusted on the max. See page 2/31.

Contacts type:

- R** = snap action
- L** = slow action
- LO** = slow action overlapped
- LS** = slow action shifted
- LV** = slow action shifted and spaced
- LI** = slow action independent
- LA** = slow action closer
- A** = electronic PNP

Contact blocks

	Other rollers available. See page 2/32	With stainless steel rollers on request	With stainless steel rollers on request	Rope switches for signalling
5 R	FL 557 1NO+1NC	FL 541 1NO+1NC	FL 542 1NO+1NC	FL 576 1NO+1NC
6 L	FL 657 1NO+1NC	Bistable switch with single track lyra lever	Bistable switch with double track lyra lever	FL 676 1NO+1NC
7 LO	FL 757 1NO+1NC			FL 776 1NO+1NC
9 L	FL 957 2NC	<p>S = mechanical snap point positive opening with 21-22 contact only</p>	FL 976 2NO	FL 1076 2NC
10 L	FL 1057 2NO		FL 1176 2NO	
11 R	FL 1157 2NC		FL 1276 2NC	
12 R	FL 1257 2NO		FL 1376 2NO	
13 LV	FL 1357 2NC		FL 1476 2NO	
14 LS	FL 1457 2NC		FL 1576 2NC	
15 LS	FL 1557 2NO		FL 1876 1NO+1NC	
16 LI	FL 1657 2NC		FL 2076 2NO+1NC	
18 LA	FL 1857 1S+1Ö		FL 2176 3NO	
20 L	FL 2057 1NO+2NC		FL 2276 1NO+2NC	
21 L	FL 2157 3NC	FL 276 2x(1NO-1NC)		
22 L	FL 2257 2NO+1NC			
2 R	FL 257 2x(1NO-1NC)			
E1 A	FL E157 1NO-1NC			
Max speed	page 7/3 - type 1	0,5 m/s with 30° cam	0,5 m/s with 30° cam	0,5 m/s
Min. force	0,1 Nm (0,25 Nm)	0,21 Nm	0,21 Nm	initial 20 N - final 40 N
Travel diagrams	page 7/4 - group 4			page 7/4 - group 6

Position switches with revolving lever without actuator

Contacts type:

- R** = snap action
- L** = slow action
- LO** = slow action overlapped
- LS** = slow action shifted
- LV** = slow action shifted and spaced
- LI** = slow action independent
- LA** = slow action closer
- PNP** = electronic PNP

Contact blocks

Regular head

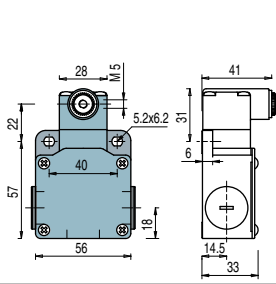

Compact head

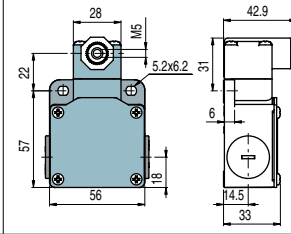
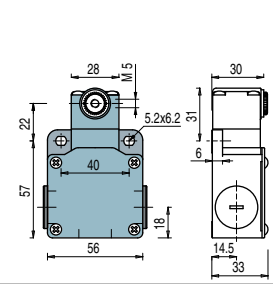

IMPORTANT

For safety applications: join only switches and actuators marked with symbol . For more information about safety applications see page 7/1.

5	R	FL 538		1NO+1NC	FL 558		1NO+1NC	FL 540		1NO+1NC
6	L	FL 638		1NO+1NC	FL 658		1NO+1NC	Bistable switch S = mechanical snap point positive opening with 21-22 contact only		
7	LO	FL 738		1NO+1NC	FL 758		1NO+1NC			
9	L	FL 938		2NC	FL 958		2NC			
10	L	FL 1038		2NO	FL 1058		2NO			
11	R	FL 1138		2NC	FL 1158		2NC			
12	R	FL 1238		2NO	FL 1258		2NO			
13	LV	FL 1338		2NC	FL 1358		2NC			
14	LS	FL 1438		2NC	FL 1458		2NC			
15	LS	FL 1538		2NO	FL 1558		2NO			
16	LI	FL 1638		2NC						
18	LA	FL 1838		1NO+1NC	FL 1858		1NO+1NC			
20	L	FL 2038		1NO+2NC	FL 2058		1NO+2NC			
21	L	FL 2138		3NC	FL 2158		3NC			
22	L	FL 2238		2NO+1NC	FL 2258		2NO+1NC			
2	R	FL 238		2x(1NO-1NC)	FL 258		2x(1NO-1NC)			
E1		FL E138		1NO-1NC	FL E158		1NO-1NC			
Min. force		0,1 Nm (0,25 Nm		0,06 Nm (0,25 Nm		0,5 m/s with 30° cam				
Travel diagrams		page 7/4 - group 4		page 7/4 - group 4		0,21 Nm				

Loose actuators

IMPORTANT: These loose actuators can be used with items of series FD, FP, FL, FC only.

Polymer roller Ø 20 mm	Adjustable round rod Ø 3x125 mm	Adjustable square rod 3x3x125 mm	Flexible rod actuator	Adjustable actuator with polymer roller	Adjustable fiber glass rod	
VF L31	VF L32 ⁽³⁾	VF L33 ⁽³⁾	VF L34	VF L35	VF L36 ⁽³⁾	
Single track lyra actuator	Double tracks lyra actuator	Polymer roller Ø 20 mm	Polymer roller Ø 20 mm	Porcelain roller	Adjustable safety actua- tor with polymer roller	Polymer roller Ø 20 mm
VF L41	VF L42	VF L51	VF L52	VF L53	VF L56	VF L57

- Only orders for multiple quantities of the packs are accepted.

(1) Actuator VF L35 suits to safety applications only if adjusted to its max length, as you can see in figure beside. If you need an adjustable lever for safety applications, use the adjustable safety lever VF L56.

(2) The position switch obtained by assembling the switch FL •58 (e.g. FL 558, FL 658) with the actuator VF L53 will not present the same travel diagrams and actuating forces as the position switch FL •53-E11V9 (e.g. FL 553-E11V9, FL 653-E11V9...).

(3) If it is installed with switch FL •58 (e.g. FL 558, FL 658...), the actuator can mechanically interfere with the housing of the switch. The interference could happen or not according to the actuator and the head fixing position.

(4) The actuator cannot be oriented to inside direction because it will mechanically interfere with the switch head.

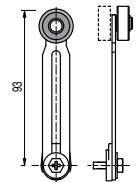

Accessories See page 6/1

Items with code on the **green** background are available in stock



Special loose actuators

IMPORTANT: These loose actuators can be used with items of series FD, FP, FL, FC only.

Ø 20 mm stainless steel rollers

VF L31-1 (1)	VF L35-1 (1) (3)	VF L51-1 (1)	VF L52-1 (1)	VF L56-1 (3)	VF L57-1 (1)

Ø 35 mm polymer rollers

VF L31-2 (4)	VF L35-2 (1) (3)	VF L51-2 (4)	VF L52-2 (1)	VF L56-2 (3)	VF L57-2 (1)

Ø 40 mm rubber rollers

VF L31-R5 (4)	VF L35-R5 (1) (3)	VF L51-R5 (4)	VF L52-R5 (1)	VF L56-R5 (3)	VF L57-R5 (4)

Ø 50 mm rubber rollers

VF L31-3 (4)	VF L35-3 (1) (3)	VF L51-3 (4)	VF L52-3 (4)	VF L56-3 (3)	VF L57-3 (4)

Ø 50 mm overhanging rubber rollers

VF L35-4 (1) (3)	VF L56-4 (3)