

Selection diagram

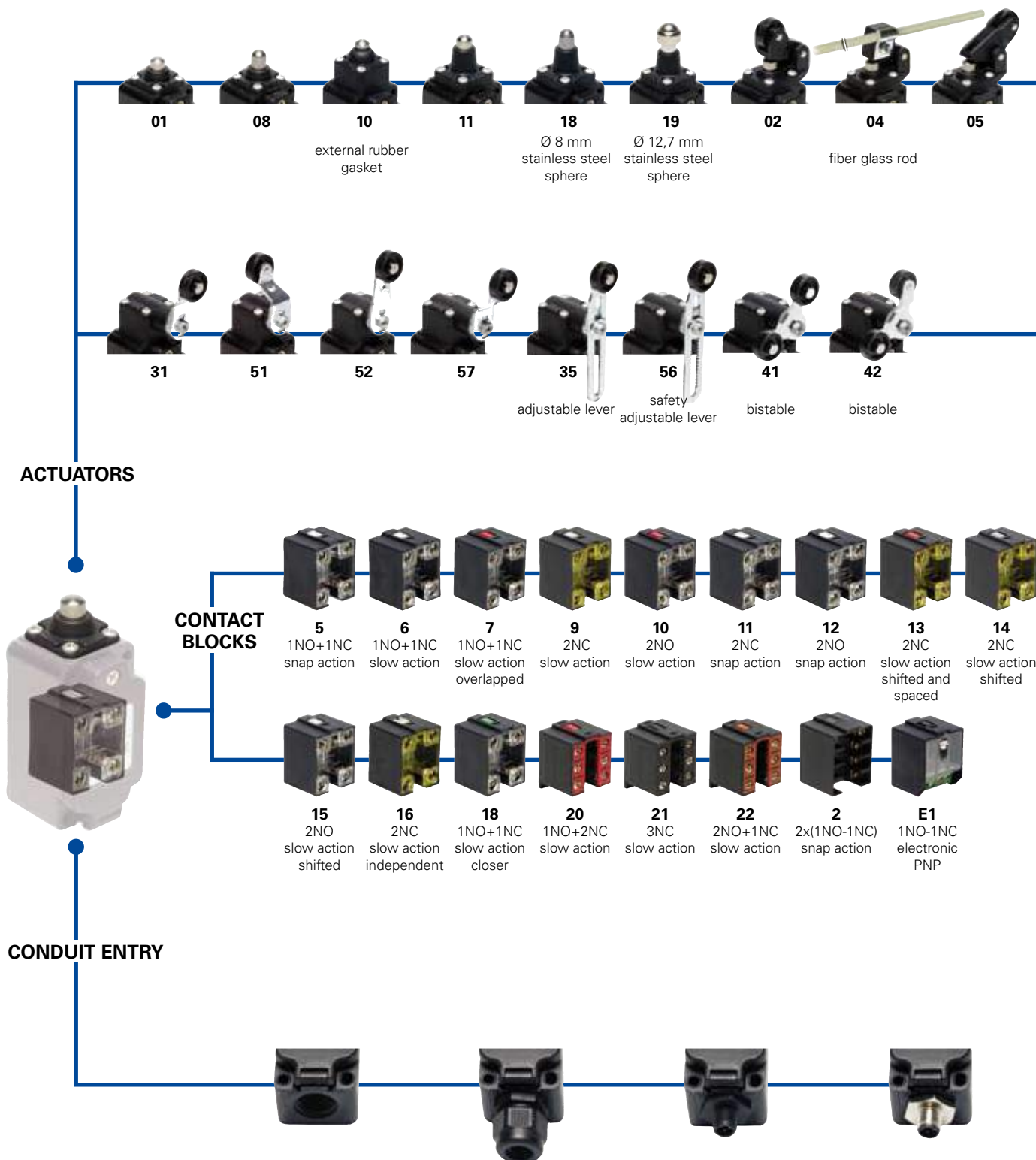

Threaded conduit entry

	PG 13,5 (standard)
M2	M20x1,5

With assembled cable gland

PG 13,5	K21	for Ø 6 to Ø 12 mm cables range
	K25	for Ø 3 to Ø 7 mm cables range
M20x1,5	K23	for Ø 6 to Ø 12 mm cables range
	K27	for Ø 3 to Ø 7 mm cables range

With M12 plastic connector assembled and wired

K70	4 poles from bottom
K45	8 poles from bottom

With M12 metal connector assembled and wired

K40	8 poles from bottom
K60	4 poles from bottom

● product option
 → accessory sold separately

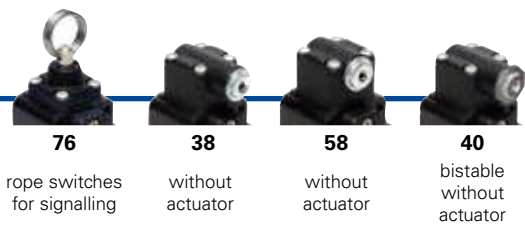
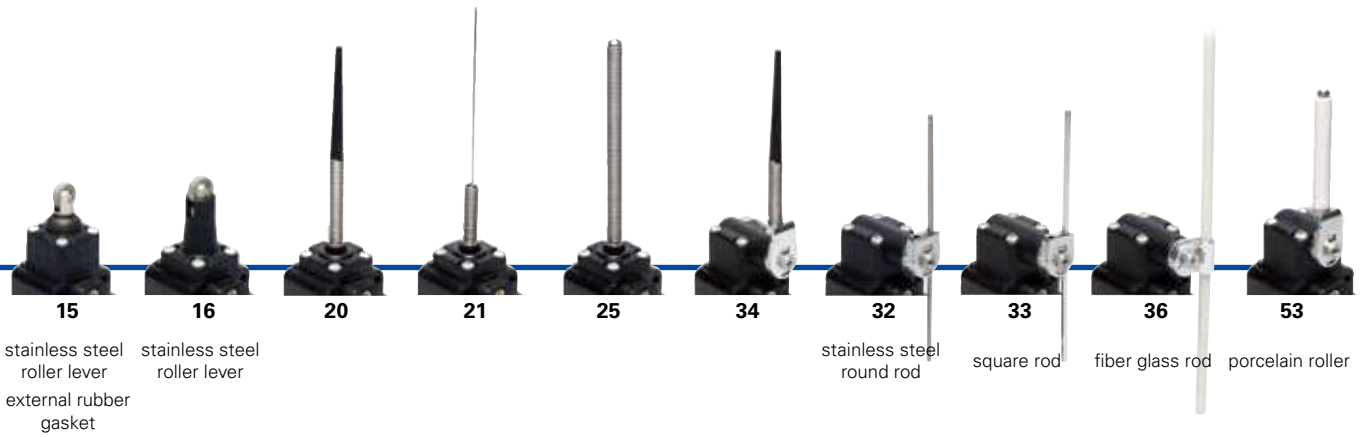

LOOSE ACTUATORS
See page 2/21



Code structure **Attention!** The feasibility of a code number does not mean the effective availability of a product. Please contact our sales office.

article options
FP 502-1GM2K70

Housing
FP polymer housing, one conduit entry

Contact blocks
5 1NO+1NC, snap action
6 1NO+1NC, slow action
7 1NO+1NC, slow action overlapped

Actuators
01 short plunger
02 roller lever
05 offset roller lever

Suffix
 no suffix (standard)
1 with Ø 20 mm stainless steel roller for actuators 02, 05, 31, 35, 51, 52, 56, 57
2 with Ø 35 mm polymer roller (see special loose actuators on page 2/22)
3 with Ø 50 mm rubber roller (see special loose actuators on page 2/22)
4 with Ø 50 mm overhanging rubber roller (see special loose actuators on page 2/22)

Preinstalled cable gland or connectors
 no cable gland or connector (standard)
K21 with assembled cable gland suitable for Ø 6 to Ø 12 mm cables range

K70 with 4 poles M12 plastic connector

For the complete list of all combinations, please contact our technical office.

Threaded conduit entry
 PG 13,5 (standard)
M2 M20x1,5

Contacts type
 silver contacts (standard)
G silver contacts gold plated 1 µm (contact block 2 excluded)



Main data

- Polymer housing, one conduit entry
- Protection degree IP67
- 17 contact blocks available
- 28 actuators available
- M12 assembled connector versions
- Silver contacts gold plated versions

Technical data

Housing

Made of glass-reinforced polymer, self-extinguishing, shock-proof thermoplastic resin and with double insulation \square

One threaded conduit entry

Protection degree: IP67 according to EN 60529

General data

Ambient temperature: from -25°C to +80°C

Version for operation in ambient temperature from -40°C to +80°C on request

Max actuation frequency: 3600 operations cycles¹/hour

Mechanical endurance: 20 million operations cycles¹

Assembling position: any

Driving torque for installation: see pages 7/1-7/10

(1) One operation cycle means two movements, one to close and one to open contacts, as foreseen by EN 60947-5-1 standard.

Cross section of the conductors (flexible copper wire)

Contact blocks 20, 21, 22, 33, 34: min. 1 x 0,34 mm² (1 x AWG 22)

max. 2 x 1,5 mm² (2 x AWG 16)

Contact blocks 5, 6, 7, 9, 10, 11, 12, 13, 14, 15, 16, 18: min. 1 x 0,5 mm² (1 x AWG 20)

max. 2 x 2,5 mm² (2 x AWG 14)

Contact block 2: min. 1 x 0,5 mm² (1 x AWG 20)

max. 2 x 1,5 mm² (2 x AWG 16)

In conformity with standards:

IEC 60947-5-1, EN 60947-5-1, EN 60947-1, EN 50041, IEC 60204-1, EN 60204-1, EN 1088, EN ISO 12100-1, EN ISO 12100-2, IEC 60529, EN 60529, NFC 63-140, VDE 0660-200, VDE 0113.

Approvals:

IEC 60947-5-1, UL 508, GB14048.5-2001.

Markings and quality marks:



Approval IMQ: EG606
 Approval UL: E131787
 Approval CCC: 2007010305230014
 Approval EZU: 1010151

In conformity with requirements requested by:

Low Voltage Directive 2006/95/EC, Machinery Directive 2006/42/EC and Electromagnetic Compatibility 2004/108/EC.

Positive contact opening in conformity with standards:

IEC 60947-5-1, EN 60947-5-1, VDE 0660-206.

Installation for safety applications:

Use only switches marked with the symbol \ominus . The safety circuit must always be connected with the **NC contacts** (normally closed contacts: 11-12, 21-22 or 31-32) as stated in the **standard EN 60947-5-1, encl. K, par. 2**. The switch must be actuated with **at least up to the positive opening travel** shown in the travels diagrams on page 7/4. The switch must be actuated **at least with the positive opening force**, shown in brackets, underneath each article, near the value of the min. force.

⚠ If not expressly indicated in this chapter, for the right installation and the correct utilization of all articles see requirements indicated from page 7/1 to page 7/10.

Electrical data

Utilization categories

without connector	Thermal current (I _{th}):	10 A	Alternate current: AC15 (50...60 Hz)			
	Rated insulation voltage (U _i):	500 Vac 600 Vdc	U _e (V)	250	400	500
		400Vac500Vdc(contact blocks 2, 11, 12, 20, 21, 22, 33, 34)	I _e (A)	6	4	1
	Rated impulse withstand voltage (U _{imp}):	6 kV	Direct current: DC13			
		4 kV (contact blocks 20, 21, 22, 33, 34)	U _e (V)	24	125	250
	Conditional short circuit current:	1000 A according to EN 60947-5-1	I _e (A)	6	1,1	0,4
	Protection against short circuits:	fuse 10 A 500 V type aM				
	Pollution degree:	3				

with 4 poles M12 connector	Thermal current (I _{th}):	4 A	Alternate current: AC15 (50...60 Hz)			
	Rated insulation voltage (U _i):	250 Vac 300 Vdc	U _e (V)	24	120	250
	Protection against short circuits:	fuse 4 A 500 V type gG	I _e (A)	4	4	4
	Pollution degree:	3	Direct current: DC13			
			U _e (V)	24	125	250
			I _e (A)	4	1,1	0,4

with 8 poles M12 connector	Thermal current (I _{th}):	2 A	Alternate current: AC15 (50...60 Hz)		
	Rated insulation voltage (U _i):	30 Vac 36 Vdc	U _e (V)	24	
	Protection against short circuits:	fuse 2 A 500 V type gG	I _e (A)	2	
	Pollution degree:	3	Direct current: DC13		
			U _e (V)	24	
			I _e (A)	2	

Data type approved by IMQ, CCC and EZU

Rated insulation voltage (Ui): 500 Vac
400 Vac (for contact blocks 2, 11, 12, 20, 21, 22, 33, 34)

Thermal current (Ith): 10 A

Protection against short circuits: fuse 10 A 500 V type aM

Rated impulse withstand voltage (U_{imp}): 6 kV
4 kV (for contact blocks 20, 21, 22, 33, 34)

Protection degree: IP67

MV terminals (screw clamps)

Pollution degree 3

Utilization category: AC15

Operation voltage (Ue): 400 Vac (50 Hz)

Operation current (Ie): 3 A

Forms of the contact element: Za, Zb, Za+Za, Y+Y, X+X, Y+Y+X, Y+Y+Y, Y+X+X

Positive opening of contacts on contact block 5, 6, 7, 9, 11, 13, 14, 16, 18, 20, 21, 22, 33, 34

In conformity with standards: EN 60947-1, EN 60947-5-1 + A1:2009, fundamental requirements of the Low Voltage Directive 2006/95/CE.

Please contact our technical service for the list of approved products.

Data type approved by UL

Utilization categories Q300 (69 VA, 125-250 Vdc)
A600 (720 VA, 120-600 Vac)

Data of the housing type 1, 4X "indoor use only", 12, 13

For all contact blocks except 2 and 3 use 60 or 75 °C copper (Cu) conductor and wire size No. 12-14 AWG. Terminal tightening torque of 7,1 lb in (0,8 Nm).
For contact blocks 2 and 3 use 60 or 75 °C copper (Cu) conductor and wire size No. 14 AWG. Terminal tightening torque of 12 lb in (1,4 Nm).

In conformity with standard: UL 508

Please contact our technical service for the list of approved products.

Adjustable levers

In switches with revolving lever it is possible to adjust the lever with 10° steps for the whole 360° range. The positive movement transmission is always guaranteed thanks to the particular geometrical coupling between the lever and the revolving shaft as prescribed for safety applications by the German standard BG-GS-ET-15.



Overturning levers

It's possible to fasten the lever on switches on straight or reverse side, maintaining the positive coupling. In this way it is possible to obtain two different work plans of the lever.



Rotating heads

In all switches, it is possible to rotate the head in 90° steps.



Working operation of contact block 16 with independent contacts

The contact block 16 has two NC contacts, **both with positive opening** activated independently according to the lever turning direction.

Lever turned to left

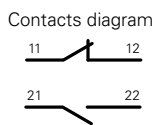

Lever not turned

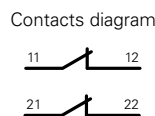

Lever turned to right

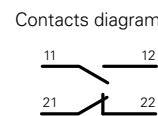

Unidirectional heads

In the switches with revolving lever, it is possible to select the directional operation by removing the four screws of the head and revolving the internal piston (contact block 16 excluded).

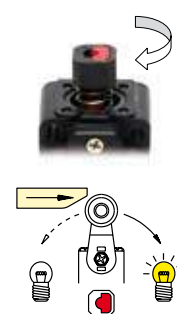
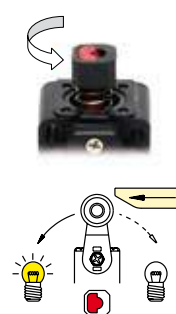
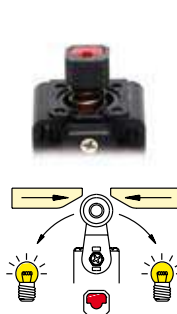

Contacts type:

- R** = snap action
- L** = slow action
- LO** = slow action overlapped
- LS** = slow action shifted
- LV** = slow action shifted and spaced
- LI** = slow action independent
- LA** = slow action closer
- PNP** = electronic PNP

Contact blocks

		With stainless steel roller on request	With stainless steel roller on request	With stainless steel roller on request
5	R FP 501	1NO+1NC	FP 502	1NO+1NC
6	L FP 601	1NO+1NC	FP 602	1NO+1NC
7	LO FP 701	1NO+1NC	FP 702	1NO+1NC
9	L FP 901	2NC	FP 902	2NC
10	L FP 1001	2NO	FP 1002	2NO
11	R FP 1101	2NC	FP 1102	2NC
12	R FP 1201	2NO	FP 1202	2NO
13	LV FP 1301	2NC	FP 1302	2NC
14	LS FP 1401	2NC	FP 1402	2NC
15	LS FP 1501	2NO	FP 1502	2NO
18	LA FP 1801	1NO+1NC	FP 1802	1NO+1NC
20	L FP 2001	1NO+2NC	FP 2002	1NO+2NC
21	L FP 2101	3NC	FP 2102	3NC
22	L FP 2201	2NO+1NC	FP 2202	2NO+1NC
2	R FP 201	2x(1NO-1NC)	FP 202	2x(1NO-1NC)
E1	PNP FP E101	1NO-1NC	FP E102	1NO-1NC
Max speed	page 7/3 - type 4		page 7/3 - type 3	
Min. force	8 N (25 N \ominus)		6 N (25 N \ominus)	
Travel diagrams	page 7/4 - group 1		page 7/4 - group 2	

		With external rubber gasket	With external rubber gasket	With external rubber gasket
5	R FP 508	1NO+1NC	FP 510	1NO+1NC
6	L FP 608	1NO+1NC	FP 610	1NO+1NC
7	LO FP 708	1NO+1NC	FP 710	1NO+1NC
9	L FP 908	2NC	FP 910	2NC
10	L FP 1008	2NO	FP 1010	2NO
11	R FP 1108	2NC	FP 1110	2NC
12	R FP 1208	2NO	FP 1210	2NO
13	LV FP 1308	2NC	FP 1310	2NC
14	LS FP 1408	2NC	FP 1410	2NC
15	LS FP 1508	2NO	FP 1510	2NO
18	LA FP 1808	1NO+1NC	FP 1810	1NO+1NC
20	L FP 2008	1NO+2NC	FP 2010	1NO+2NC
21	L FP 2108	3NC	FP 2110	3NC
22	L FP 2208	2NO+1NC	FP 2210	2NO+1NC
2	R FP 208	2x(1NO-1NC)	FP 210	2x(1NO-1NC)
E1	PNP FP E108	1NO-1NC	FP E110	1NO-1NC
Max speed	page 7/3 - type 4		page 7/3 - type 4	
Min. force	8 N (25 N \ominus)		11 N (25 N \ominus)	
Travel diagrams	page 7/4 - group 1		page 7/4 - group 1	

Accessories See page 6/1

All measures in the drawings are in mm



Contacts type:

- R** = snap action
- L** = slow action
- LO** = slow action overlapped
- LS** = slow action shifted
- LV** = slow action shifted and spaced
- LI** = slow action independent
- LA** = slow action closer
- E** = electronic PNP

Contact blocks

		Ø 8 mm stainless steel sphere	Ø 12,7 mm stainless steel sphere	With external rubber gasket
5 R	FP 516 → 1NO+1NC	FP 518 → 1NO+1NC	FP 519 → 1NO+1NC	FP 520 1NO+1NC
6 L	FP 616 → 1NO+1NC	FP 618 → 1NO+1NC	FP 619 → 1NO+1NC	
7 LO	FP 716 → 1NO+1NC	FP 718 → 1NO+1NC	FP 719 → 1NO+1NC	
9 L	FP 916 → 2NC	FP 918 → 2NC	FP 919 → 2NC	
10 L	FP 1016 2NO	FP 1018 2NO	FP 1019 2NO	FP 1020 2NO
11 R	FP 1116 → 2NC	FP 1118 → 2NC	FP 1119 → 2NC	
12 R	FP 1216 2NO	FP 1218 2NO	FP 1219 2NO	
13 LV	FP 1316 → 2NC	FP 1318 → 2NC	FP 1319 → 2NC	
14 LS	FP 1416 → 2NC	FP 1418 → 2NC	FP 1419 → 2NC	
15 LS	FP 1516 2NO	FP 1518 2NO	FP 1519 2NO	
18 LA	FP 1816 → 1S+1Ö	FP 1818 → 1S+1Ö	FP 1819 → 1S+1Ö	FP 1820 1NO+1NC
20 L	FP 2016 → 1NO+2NC	FP 2018 → 1NO+2NC	FP 2019 → 1NO+2NC	FP 2020 1NO+2NC
21 L	FP 2116 → 3NC	FP 2118 → 3NC	FP 2119 → 3NC	FP 2120 3NC
22 L	FP 2216 → 2NO+1NC	FP 2218 → 2NO+1NC	FP 2219 → 2NO+1NC	FP 2220 2NO+1NC
2 R	FP 216 2x(1NO-1NC)	FP 218 2x(1NO-1NC)	FP 219 2x(1NO-1NC)	FP 220 2x(1NO-1NC)
E1 E	FP E116 1NO-1NC	FP E118 1NO-1NC	FP E119 1NO-1NC	FP E120 1NO-1NC
Max speed	page 7/3 - type 2	page 7/3 - type 4	page 7/3 - type 4	1 m/s
Min. force	8 N (25 N →)	8 N (25 N →)	8 N (25 N →)	0,09 Nm
Travel diagrams	page 7/4 - group 1	page 7/4 - group 1	page 7/4 - group 1	page 7/4 - group 3











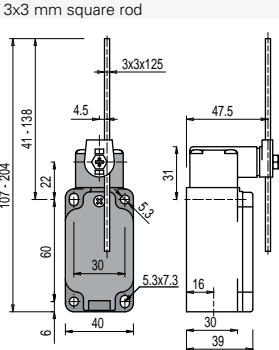
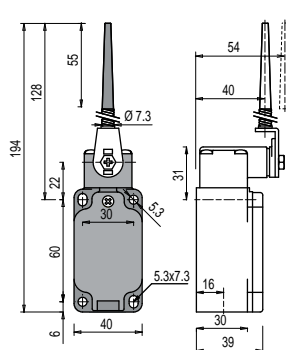
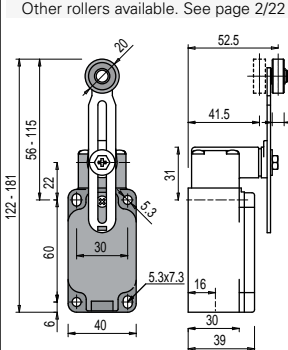
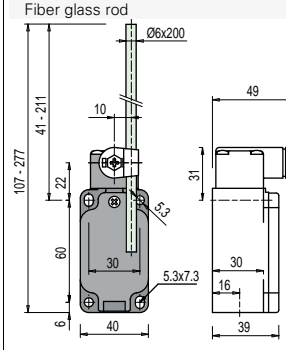



	With external rubber gasket	With external rubber gasket	Other rollers available. See page 2/22	Ø 3 mm stainless steel round rod
5 R	FP 521 1NO+1NC	FP 525 1NO+1NC	FP 531 → 1NO+1NC	FP 532 1NO+1NC
6 L			FP 631 → 1NO+1NC	FP 632 1NO+1NC
7 LO			FP 731 → 1NO+1NC	FP 732 1NO+1NC
9 L			FP 931 → 2NC	FP 932 2NC
10 L	FP 1021 2NO	FP 1025 2NO	FP 1031 2NO	FP 1032 2NO
11 R			FP 1131 → 2NC	FP 1132 2NC
12 R			FP 1231 2NO	FP 1232 2NO
13 LV			FP 1331 → 2NC	FP 1332 2NC
14 LS			FP 1431 → 2NC	FP 1432 2NC
15 LS			FP 1531 2NO	FP 1532 2NO
16 LI			FP 1631 → 2NC	FP 1632 2NC
18 LA	FP 1821 1NO+1NC	FP 1825 1NO+1NC	FP 1831 → 1NO+1NC	FP 1832 1S+1Ö
20 L	FP 2021 1NO+2NC	FP 2025 1NO+2NC	FP 2031 → 1NO+2NC	FP 2032 1NO+2NC
21 L	FP 2121 3NC	FP 2125 3NC	FP 2131 → 3NC	FP 2132 3NC
22 L	FP 2221 2NO+1NC	FP 2225 2NO+1NC	FP 2231 → 2NO+1NC	FP 2232 2NO+1NC
2 R	FP 221 2x(1NO-1NC)	FP 225 2x(1NO-1NC)	FP 231 2x(1NO-1NC)	FP 232 2x(1NO-1NC)
E1 E	FP E121 1NO-1NC	FP E125 1NO-1NC	FP E131 1NO-1NC	FP E132 1NO-1NC
Max speed	1 m/s	1 m/s	page 7/3 - type 1	1,5 m/s
Min. force	0,08 Nm	0,14 Nm	0,1 Nm (0,25 Nm →)	0,1 Nm
Travel diagrams	page 7/4 - group 3	page 7/4 - group 3	page 7/4 - group 4	page 7/4 - group 4











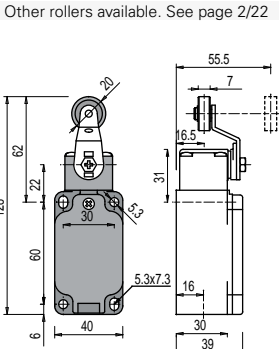
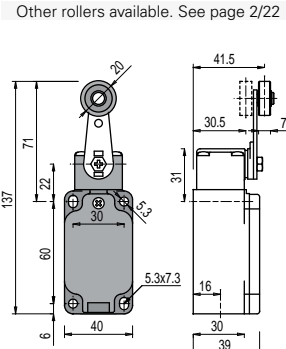
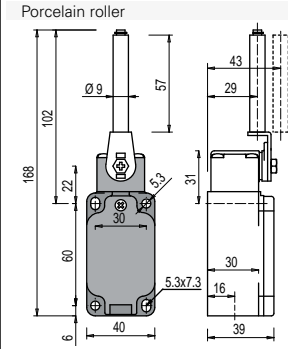
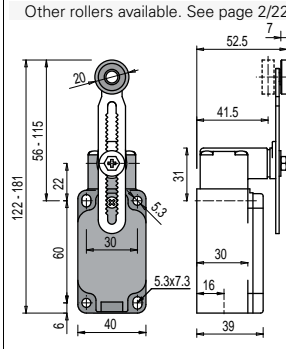









































Items with code on the green background are available in stock

Contacts type:

- R** = snap action
- L** = slow action
- LO** = slow action overlapped
- LS** = slow action shifted
- LV** = slow action shifted and spaced
- LI** = slow action independent
- LA** = slow action closer
-  = electronic PNP

Contact blocks

				
5	R FP 533 1NO+1NC	FP 534 1NO+1NC	FP 535  ⁽¹⁾ 1NO+1NC	FP 536 1NO+1NC
6	L FP 633 1NO+1NC	FP 634 1NO+1NC	FP 635  ⁽¹⁾ 1NO+1NC	FP 636 1NO+1NC
7	LO FP 733 1NO+1NC	FP 734 1NO+1NC	FP 735  ⁽¹⁾ 1NO+1NC	FP 736 1NO+1NC
9	L FP 933 2NC	FP 934 2NC	FP 935  ⁽¹⁾ 2NC	FP 936 2NC
10	L FP 1033 2NO	FP 1034 2NO	FP 1035 2NO	FP 1036 2NO
11	R FP 1133 2NC	FP 1134 2NC	FP 1135  ⁽¹⁾ 2NC	FP 1136 2NC
12	R FP 1233 2NO	FP 1234 2NO	FP 1235 2NO	FP 1236 2NO
13	LV FP 1333 2NC	FP 1334 2NC	FP 1335  ⁽¹⁾ 2NC	FP 1336 2NC
14	LS FP 1433 2NC	FP 1434 2NC	FP 1435  ⁽¹⁾ 2NC	FP 1436 2NC
15	LS FP 1533 2NO	FP 1534 2NO	FP 1535 2NO	FP 1536 2NO
16	LI FP 1633 2NC	FP 1634 2NC	FP 1635  ⁽¹⁾ 2NC	FP 1636 2NC
18	LA FP 1833 1S+1Ö	FP 1834 1S+1Ö	FP 1835  ⁽¹⁾ 1S+1Ö	FP 1836 1S+1Ö
20	L FP 2033 1NO+2NC	FP 2034 1NO+2NC	FP 2035  ⁽¹⁾ 1NO+2NC	FP 2036 1NO+2NC
21	L FP 2133 3NC	FP 2134 3NC	FP 2135  ⁽¹⁾ 3NC	FP 2136 3NC
22	L FP 2233 2NO+1NC	FP 2234 2NO+1NC	FP 2235  ⁽¹⁾ 2NO+1NC	FP 2236 2NO+1NC
2	R FP 233 2x(1NO-1NC)	FP 234 2x(1NO-1NC)	FP 235 2x(1NO-1NC)	FP 236 2x(1NO-1NC)
E1	 FP E133 1NO-1NC	FP E134 1NO-1NC	FP E135 1NO-1NC	FP E136 1NO-1NC
Max speed	1,5 m/s	1 m/s	page 7/3 - type 1	1,5 m/s
Min. force	0,1 Nm	0,1 Nm	0,1 Nm (0,25 Nm )	0,1 Nm
Travel diagrams	page 7/4 - group 4	page 7/4 - group 4	page 7/4 - group 4	page 7/4 - group 4

				
5	R FP 551  1NO+1NC	FP 552  1NO+1NC	FP 553-E11V9  1NO+1NC	FP 556  1NO+1NC
6	L FP 651  1NO+1NC	FP 652  1NO+1NC	FP 653-E11V9  1NO+1NC	FP 656  1NO+1NC
7	LO FP 751  1NO+1NC	FP 752  1NO+1NC	FP 753-E11V9  1NO+1NC	FP 756  1NO+1NC
9	L FP 951  2NC	FP 952  2NC	FP 953-E11V9  2NC	FP 956  2NC
10	L FP 1051 2NO	FP 1052 2NO	FP 1053-E11V9 2NO	FP 1056 2NO
11	R FP 1151  2NC	FP 1152  2NC	FP 1253-E11V9 2NO	FP 1156  2NC
12	R FP 1251 2NO	FP 1252 2NO	FP 1353-E11V9  2NC	FP 1256 2NO
13	LV FP 1351  2NC	FP 1352  2NC	FP 1453-E11V9  2NC	FP 1356  2NC
14	LS FP 1451  2NC	FP 1452  2NC	FP 1553-E11V9 2NO	FP 1456  2NC
15	LS FP 1551 2NO	FP 1552 2NO	FP 1553-E11V9 2NO	FP 1556 2NO
16	LI FP 1651  2NC	FP 1652  2NC	FP 1853-E11V9  1S+1Ö	FP 1656  2NC
18	LA FP 1851  1NO+1NC	FP 1852  1S+1Ö	FP 2053-E11V9  1NO+2NC	FP 1856  1S+1Ö
20	L FP 2051  1NO+2NC	FP 2052  1NO+2NC	FP 2153-E11V9  3NC	FP 2056  1NO+2NC
21	L FP 2151  3NC	FP 2152  3NC	FP 2253-E11V9  2NO+1NC	FP 2156  3NC
22	L FP 2251  2NO+1NC	FP 2252  2NO+1NC	FP 253-E11 2x(1NO-1NC)	FP 2256  2NO+1NC
2	R FP 251 2x(1NO-1NC)	FP 252 2x(1NO-1NC)	FP 253-E11 2x(1NO-1NC)	FP 256 2x(1NO-1NC)
E1	 FP E151 1NO-1NC	FP E152 1NO-1NC	FP E153-E11V9 1NO-1NC	FP E156 1NO-1NC
Max speed	page 7/3 - type 1	page 7/3 - type 1	0,5 m/s	page 7/3 - type 1
Min. force	0,06 Nm (0,25 Nm )	0,06 Nm (0,25 Nm )	0,0. Nm (0,25 Nm )	0,1 Nm (0,25 Nm )
Travel diagrams	page 7/4 - group 4	page 7/4 - group 4	page 7/4 - group 5	page 7/4 - group 4

Accessories See page 6/1

⁽¹⁾ Positive opening only with lever adjusted on the max. See page 2/21.

Contacts type:

- R** = snap action
- L** = slow action
- LO** = slow action overlapped
- LS** = slow action shifted
- LV** = slow action shifted and spaced
- LI** = slow action independent
- LA** = slow action closer
- A** = electronic PNP

Contact blocks

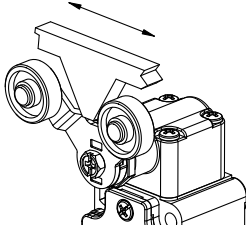
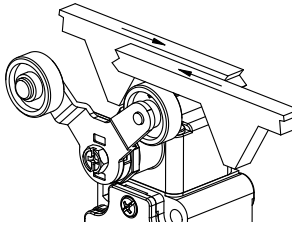
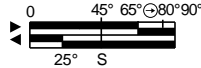
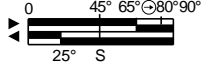
	Other rollers available. See page 2/22	With stainless steel rollers on request	With stainless steel rollers on request	Rope switches for signalling
5	R FP 557	R FP 541	R FP 542	R FP 576
6	L FP 657			L FP 676
7	LO FP 757	Bistable switch with single track lyra lever	Bistable switch with double track lyra lever	LO FP 776
9	L FP 957			L FP 976
10	L FP 1057			L FP 1076
11	R FP 1157	S = mechanical snap point positive opening with 21-22 contact only	S = mechanical snap point positive opening with 21-22 contact only	R FP 1176
12	R FP 1257			R FP 1276
13	LV FP 1357			LV FP 1376
14	LS FP 1457			LS FP 1476
15	LS FP 1557			LS FP 1576
16	LI FP 1657			LI FP 1876
18	LA FP 1857			LA FP 2076
20	L FP 2057			L FP 2176
21	L FP 2157			L FP 2276
22	L FP 2257			L FP 276
2	R FP 257			
E1	A FP E157			
Max speed	page 7/3 - type 1	0,5 m/s with 30° cam	0,5 m/s with 30° cam	0,5 m/s
Min. force	0,1 Nm (0,25 Nm R)	0,21 Nm	0,21 Nm	initial 20 N - final 40 N
Travel diagrams	page 7/4 - group 4			page 7/4 - group 6

 Items with code on the **green** background are available in stock

Position switches with revolving lever without actuator

Contacts type:

- R** = snap action
- L** = slow action
- LO** = slow action overlapped
- LS** = slow action shifted
- LV** = slow action shifted and spaced
- LI** = slow action independent
- LA** = slow action closer
- ⏏** = electronic PNP

Contact blocks

Regular head

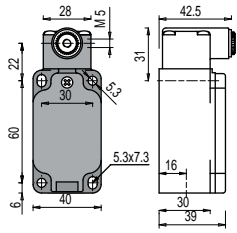

Compact head

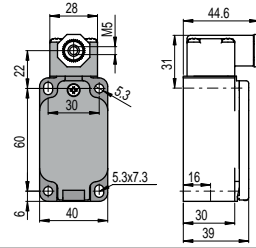
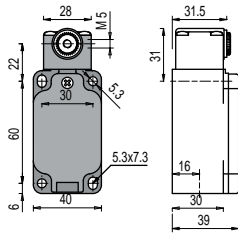

IMPORTANT

For safety applications: join only switches and actuators marked with symbol For more information about safety applications see page 7/1.

5	R	FP 538		1NO+1NC	FP 558		1NO+1NC	FP 540 1NO+1NC Bistable switch S = mechanical snap point positive opening with 21-22 contact only
6	L	FP 638		1NO+1NC	FP 658		1NO+1NC	
7	LO	FP 738		1NO+1NC	FP 758		1NO+1NC	
9	L	FP 938		2NC	FP 958		2NC	
10	L	FP 1038		2NO	FP 1058		2NO	
11	R	FP 1138		2NC	FP 1158		2NC	
12	R	FP 1238		2NO	FP 1258		2NO	
13	LV	FP 1338		2NC	FP 1358		2NC	
14	LS	FP 1438		2NC	FP 1458		2NC	
15	LS	FP 1538		2NO	FP 1558		2NO	
16	LI	FP 1638		2NC				
18	LA	FP 1838		1NO+1NC	FP 1858		1NO+1NC	
20	L	FP 2038		1NO+2NC	FP 2058		1NO+2NC	
21	L	FP 2138		3NC	FP 2158		3NC	
22	L	FP 2238		2NO+1NC	FP 2258		2NO+1NC	
2	R	FP 238		2x(1NO-1NC)	FP 258		2x(1NO-1NC)	
E1		FP E138		1NO+1NC	FP E158		1NO+1NC	
Min. force		0,1 Nm (0,25 Nm)		0,06 Nm (0,25 Nm)		0,5 m/s with 30° cam		
Travel diagrams		page 7/4 - group 4		page 7/4 - group 4		0,21 Nm		

Loose actuators

IMPORTANT: These loose actuators can be used with items of series FD, FP, FL, FC only.

Polymer roller Ø 20 mm	Adjustable round rod Ø 3x125 mm	Adjustable square rod 3x3x125 mm	Flexible rod actuator	Adjustable actuator with polymer roller	Adjustable fiber glass rod	
VF L31	VF L32 ⁽³⁾	VF L33 ⁽³⁾	VF L34	VF L35 ^{(1) (3)}	VF L36 ⁽³⁾	
Single track lyra actuator	Double tracks lyra actuator	Polymer roller Ø 20 mm	Polymer roller Ø 20 mm	Porcelain roller	Adjustable safety actua- tor with polymer roller	Polymer roller Ø 20 mm
VF L41	VF L42	VF L51	VF L52	VF L53 ⁽²⁾	VF L56 ⁽³⁾	VF L57

- Only orders for multiple quantities of the packs are accepted.

⁽¹⁾ Actuator VF L35 suits to safety applications only if adjusted to its max length, as you can see in figure beside. If you need an adjustable lever for safety applications, use the adjustable safety lever VF L56.

⁽²⁾ The position switch obtained by assembling the switch FP •58 (e.g. FP 558, FP 658) with the actuator VF L53 will not present the same travel diagrams and actuating forces as the position switch FP •53-E11V9 (e.g. FP 553-E11V9, FP 653-E11V9...).

⁽³⁾ If it is installed with switch FP •58 (e.g. FP 558, FP 658...), the actuator can mechanically interfere with the housing of the switch. The interference could happen or not according to the actuator and the head fixing position.

⁽⁴⁾ The actuator cannot be oriented to inside direction because it will mechanically interfere with the switch head.

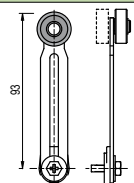

Accessories See page 6/1

Items with code on the **green** background are available in stock



Special loose actuators

IMPORTANT: These loose actuators can be used with items of series FD, FP, FL, FC only.

Ø 20 mm stainless steel rollers

VF L31-1 (1)	VF L35-1 (1) (3)	VF L51-1 (1)	VF L52-1 (1)	VF L56-1 (3)	VF L57-1 (1)

Ø 35 mm polymer rollers

VF L31-2 (4)	VF L35-2 (1) (3)	VF L51-2 (4)	VF L52-2 (1)	VF L56-2 (3)	VF L57-2 (1)

Ø 40 mm rubber rollers

VF L31-R5 (4)	VF L35-R5 (1) (3)	VF L51-R5 (4)	VF L52-R5 (1)	VF L56-R5 (3)	VF L57-R5 (4)

Ø 50 mm rubber rollers

VF L31-3 (4)	VF L35-3 (1) (3)	VF L51-3 (4)	VF L52-3 (4)	VF L56-3 (3)	VF L57-3 (4)

Ø 50 mm overhanging rubber rollers

VF L35-4 (1) (3)	VF L56-4 (3)