

MICRO SWITCH™ GLL Series

Limit Switches



DESCRIPTION

Honeywell MICRO SWITCH™ GLL Series limit switches are part of the OEM set of miniature limit switches. They combine and enhance MICRO SWITCH™ GLS and SZL-VL switches into one common family, competitively priced for OEM applications.

The double insulated compact housing conforms to EN500047 and makes GLL Series switches often ideal for mounting where space is at a premium. These products feature direct opening normally closed circuits.

FEATURES

- Double break, direct-opening snap action contacts conform to IEC 60947-5-1-3 
- EN50047 mounting
- 20 mm and 1/2 in NPT conduit options
- Galvanically isolated contacts
- Double insulated plastic housing
- Snap action and slow action circuitry
- Contact block integral to switch housing
- Hinge cover for easy wiring access
- 50 mm rubber rollers ideal for elevator applications
- Sealing IP66; NEMA 1, 12, 13
- c-UL-US, CE, CCC
- rOhs compliant







The MICRO SWITCH™ GLL Series is available in a variety of actuator styles required for OEM applications. Designed to the IEC electrical standard, GLL is suitable for world-wide use and also meets globally accepted mounting standards.

The GLL Series provides a cost-effective solution for OEM high volume applications and enables manufacturers to be competitive in today's demanding business environment.

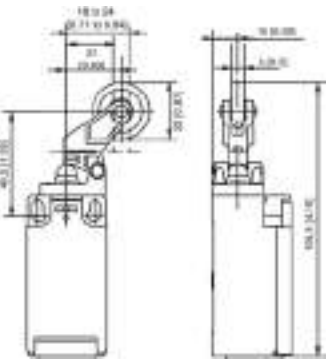
POTENTIAL APPLICATIONS

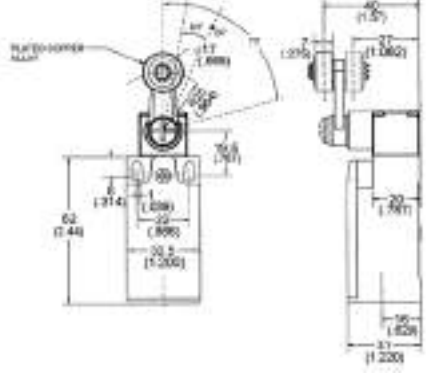
- Elevators
- Escalators
- Aerial/platform lifts
- Industrial doors
- Packaging equipment

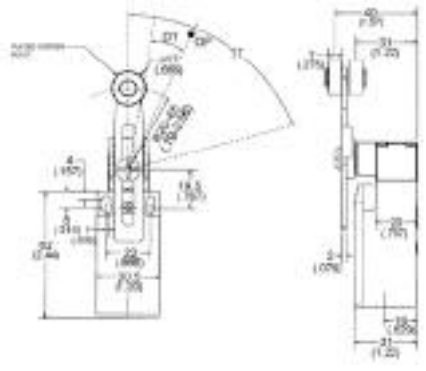
Limit Switches

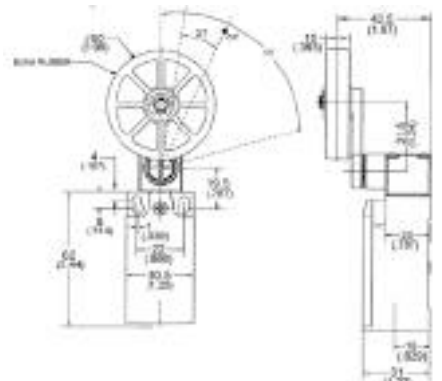
<p>GLLA**F, GLLC**F</p> 		<table border="0"> <tr> <td>Snap Action 1NO/1NC</td> <td>Slow Action (Break Before Make) 1NO/1NC</td> <td>Slow Action (Make Before Break) 1NO/1NC</td> <td>Slow Action 2NC</td> </tr> <tr> <td></td> <td></td> <td></td> <td></td> </tr> <tr> <td></td> <td></td> <td></td> <td></td> </tr> </table>	Snap Action 1NO/1NC	Slow Action (Break Before Make) 1NO/1NC	Slow Action (Make Before Break) 1NO/1NC	Slow Action 2NC								
Snap Action 1NO/1NC	Slow Action (Break Before Make) 1NO/1NC	Slow Action (Make Before Break) 1NO/1NC	Slow Action 2NC											
<p>GLLA**A1B, GLLC**A1B</p> 		<table border="0"> <tr> <td>Snap Action 1NO/1NC</td> <td>Slow Action (Break Before Make) 1NO/1NC</td> <td>Slow Action (Make Before Break) 1NO/1NC</td> <td>Slow Action 2NC</td> </tr> <tr> <td></td> <td></td> <td></td> <td></td> </tr> <tr> <td></td> <td></td> <td></td> <td></td> </tr> </table>	Snap Action 1NO/1NC	Slow Action (Break Before Make) 1NO/1NC	Slow Action (Make Before Break) 1NO/1NC	Slow Action 2NC								
Snap Action 1NO/1NC	Slow Action (Break Before Make) 1NO/1NC	Slow Action (Make Before Break) 1NO/1NC	Slow Action 2NC											
<p>GLLA**A2B, GLLC**A2B</p> 		<table border="0"> <tr> <td>Snap Action 1NO/1NC</td> <td>Slow Action (Break Before Make) 1NO/1NC</td> <td>Slow Action (Make Before Break) 1NO/1NC</td> <td>Slow Action 2NC</td> </tr> <tr> <td></td> <td></td> <td></td> <td></td> </tr> <tr> <td></td> <td></td> <td></td> <td></td> </tr> </table>	Snap Action 1NO/1NC	Slow Action (Break Before Make) 1NO/1NC	Slow Action (Make Before Break) 1NO/1NC	Slow Action 2NC								
Snap Action 1NO/1NC	Slow Action (Break Before Make) 1NO/1NC	Slow Action (Make Before Break) 1NO/1NC	Slow Action 2NC											
<p>GLLA**A1Y, GLLC**A1Y</p> 		<table border="0"> <tr> <td>Snap Action 1NO/1NC</td> <td>Slow Action (Break Before Make) 1NO/1NC</td> <td>Slow Action (Make Before Break) 1NO/1NC</td> <td>Slow Action 2NC</td> </tr> <tr> <td></td> <td></td> <td></td> <td></td> </tr> <tr> <td></td> <td></td> <td></td> <td></td> </tr> </table>	Snap Action 1NO/1NC	Slow Action (Break Before Make) 1NO/1NC	Slow Action (Make Before Break) 1NO/1NC	Slow Action 2NC								
Snap Action 1NO/1NC	Slow Action (Break Before Make) 1NO/1NC	Slow Action (Make Before Break) 1NO/1NC	Slow Action 2NC											

MICRO SWITCH™ GLL Series

GLLA**A2Y, GLLC**A2Y

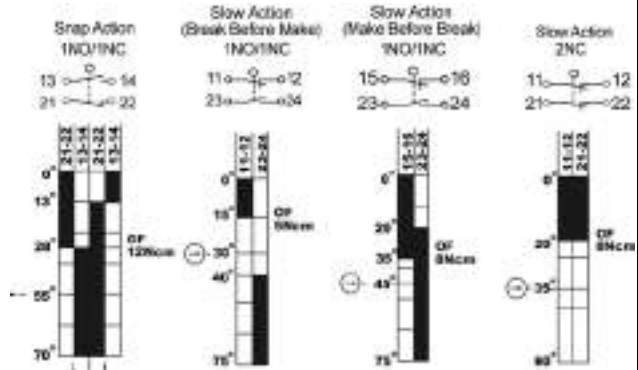
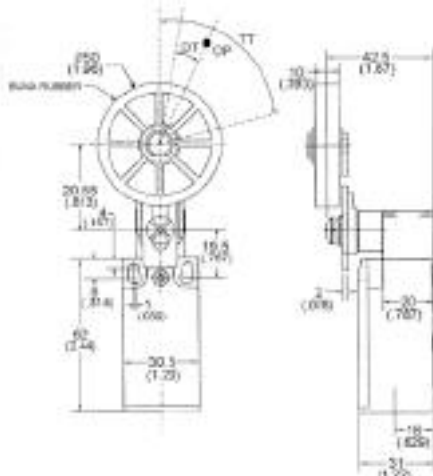

GLLA**A4J, GLLC**A4J

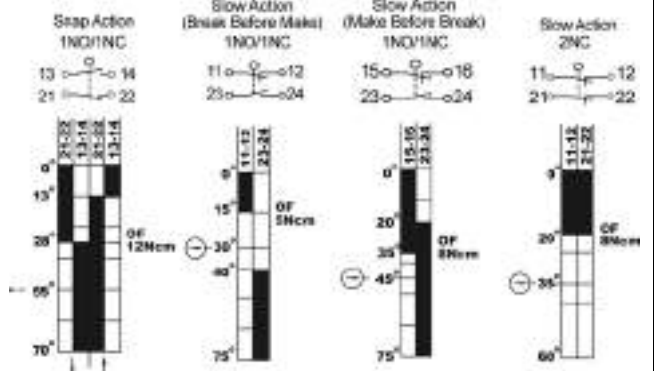
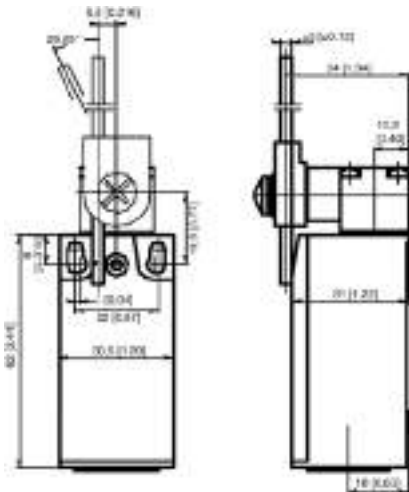

Limit Switches

MICRO SWITCH™ GLL MIN-DIN (EN500047) PLASTIC

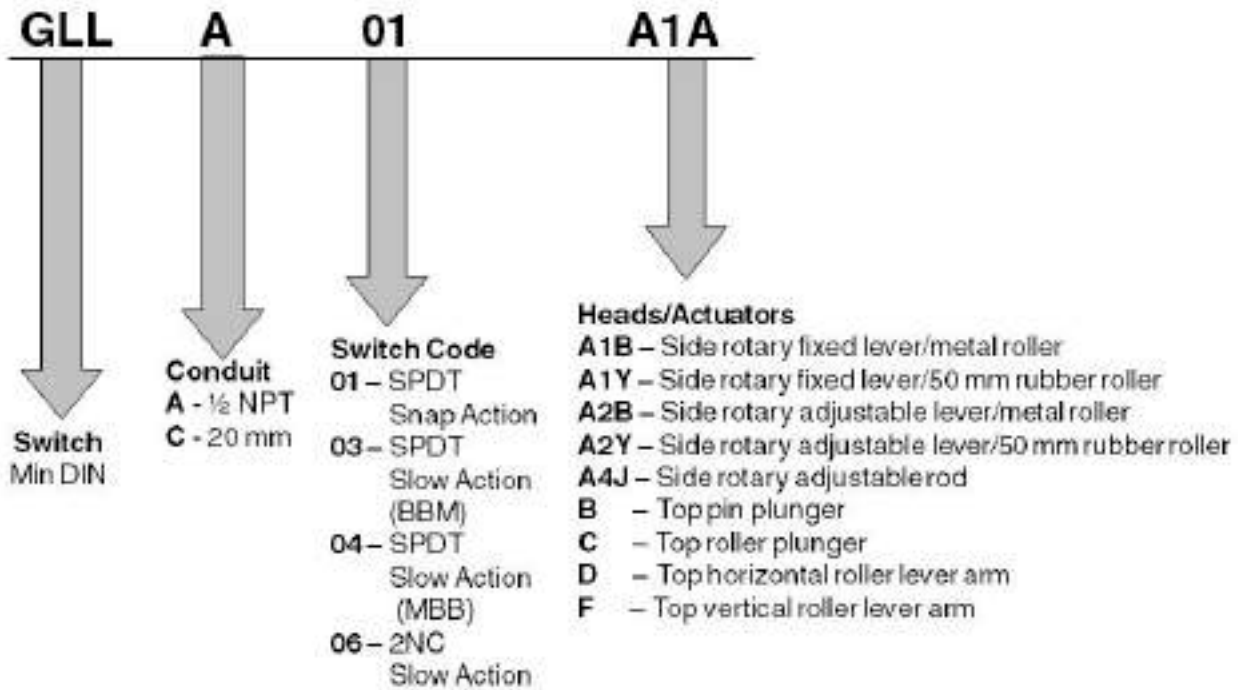

WARNING

PERSONAL INJURY

DO NOT USE these products as safety or emergency stop devices or in any other application where failure of the product could result in personal injury.

Failure to comply with these instructions could result in death or serious injury.

WARRANTY/REMEDY

Honeywell warrants goods of its manufacture as being free of defective materials and faulty workmanship. Honeywell's standard product warranty applies unless agreed to otherwise by Honeywell in writing; please refer to your order acknowledgement or consult your local sales office for specific warranty details. If warranted goods are returned to Honeywell during the period of coverage, Honeywell will repair or replace, at its option, without charge those items it finds defective. **The foregoing is buyer's sole remedy and is in lieu of all other warranties, expressed or implied, including those of merchantability and fitness for a particular purpose. In no event shall Honeywell be liable for consequential, special, or indirect damages.**

While we provide application assistance personally, through our literature and the Honeywell web site, it is up to the customer to determine the suitability of the product in the application.

WARNING

MISUSE OF DOCUMENTATION

- The information presented in this product sheet is for reference only. Do not use this document as a product installation guide.
- Complete installation, operation, and maintenance information is provided in the instructions supplied with each product.

Failure to comply with these instructions could result in death or serious injury.

Specifications may change without notice. The information we supply is believed to be accurate and reliable as of this printing. However, we assume no responsibility for its use.

SALES AND SERVICE

Honeywell serves its customers through a worldwide network of sales offices, representatives and distributors. For application assistance, current specifications, pricing or name of the nearest Authorized Distributor, contact your local sales office or:

E-mail: info.sc@honeywell.com

Internet: www.honeywell.com/sensing

Phone and Fax:

Asia Pacific	+65 6355-2828
	+65 6445-3033 Fax
Europe	+44 (0) 1698 481481
	+44 (0) 1698 481676 Fax
Latin America	+1-305-805-8188
	+1-305-883-8257 Fax
USA/Canada	+1-800-537-6945
	+1-815-235-6847
	+1-815-235-6545 Fax

Sensing and Control

Honeywell

1985 Douglas Drive North

Golden Valley, Minnesota 55422

www.honeywell.com

002310-3-EN IL50 GLO Printed in USA
January 2011

© 2011 Honeywell International Inc. All Rights Reserved

Honeywell