

**D-SERIES DRI
DRI424730**

Weidmüller Interface GmbH & Co. KG
 Klingenbergstraße 26
 D-32758 Detmold
 Germany
 Fon: +49 5231 14-0
 Fax: +49 5231 14-292083
 www.weidmueller.com

Product image

Similar to illustration

Relay from the D-SERIES DRI

- 1 or 2 CO contacts
- Robust industrial plug-in connections
- Optional: latching / spring return operable test button with coloured control voltage identification (AC coil: red / DC coil: blue)
- Optional: Mechanical switch position indication (for version with test button)
- Optional: Bright status LED (AC coil: red / DC coil: green)
- Optional: free-wheeling diode

General ordering data

Type	DRI424730
Order No.	7760056327
Version	D-SERIES DRI, Relay, Number of contacts: 2 CO contact AgNi, Rated control voltage: 230 V AC, Continuous current: 5 A, Flat blade connections (2.5 mm x 0.5 mm)
GTIN (EAN)	6944 169740329
Qty.	20 pc(s).

**D-SERIES DRI
DRI424730**

Weidmüller Interface GmbH & Co. KG
 Klingenbergstraße 26
 D-32758 Detmold
 Germany
 Fon: +49 5231 14-0
 Fax: +49 5231 14-292083
 www.weidmueller.com

Technical data**Dimensions and weights**

Width	13 mm	Width (inches)	0.512 inch
Height	31 mm	Height (inches)	1.22 inch
Depth	28 mm	Depth (inches)	1.102 inch
Net weight	19 g		

Temperatures

Humidity	35...85 % rel. humidity, no condensation	Operating temperature, max.	55 °C
Operating temperature, min.	-40 °C	Storage temperature, max.	85 °C
Storage temperature, min.	-40 °C	Operating temperature	-40 °C...55 °C
Storage temperature	-40 °C...85 °C		

Environmental Product Compliance

REACH SVHC	Lead 7439-92-1
------------	----------------

Rated data UL

Certificate No. (cURus)	E312083
-------------------------	---------

Input

Rated control voltage	230 V AC	Rated current AC	4,9 mA
Power rating	1.1 VA	Pull-in/drop-out voltage, typ.	184 V / 69 V AC
Coil resistance	23500 Ω ± 10 %		

Output

Rated switching voltage	250 V AC	Max. switching voltage, AC	250 V
Max. switching voltage, DC	250 V	Continuous current	5 A
AC switching capacity (resistive), max.	1250 VA	DC switching capacity (resistive), max.	150 W @ 24 V
Switch-on delay	≤ 15 ms	Switch-off delay	≤ 10 ms
Min. switching power	10 mA @ 12 V, 100 mA @ 5 V	Max. switching frequency at rated load	0.1 Hz

Contact data

Contact type	2 CO contact (AgNi)	Mechanical service life	10 x 10 ⁶ switching cycles
--------------	---------------------	-------------------------	---------------------------------------

General data

Test button	No	Mechanical switch position indicator	No
Colour	Transparent	UL 94 flammability rating	V-2

Insulation coordination

Rated voltage	300 V	Surge voltage category	III
Pollution severity	2	Insulating material group	IIIa
Protection degree	IP20	Dielectric strength, Input/Output	5 kV _{eff} / 1 min
Creepage and clearance distance input - output	≥ 4 mm	Dielectric strength of neighbouring contacts	1.5 kV _{eff} / 1 min.
Dielectric strength of open contact	1 kV _{eff} / 1 min	Impulse withstand voltage	5 kV (1.2/50 μs)

Data sheet

**D-SERIES DRI
DRI424730**

Weidmüller Interface GmbH & Co. KG
Klingenbergstraße 26
D-32758 Detmold
Germany
Fon: +49 5231 14-0
Fax: +49 5231 14-292083
www.weidmueller.com

Technical data

Further details of approvals / standards

Standards	IEC 61810-1, EN 60664-1:2007, EN 61000-6-2:2005, EN 61000-6-4:2007 + A1:2011, UL 508	Certificate No. (cURus)	E312083
-----------	--	-------------------------	---------

Connection data

Wire connection method	Flat blade connections (2.5 mm x 0.5 mm)
------------------------	--

Classifications

ETIM 6.0	EC001437	ETIM 7.0	EC001437
eClass 9.0	27-37-16-01	eClass 9.1	27-37-16-01
eClass 10.0	27-37-16-01		

Approvals

Approvals



ROHS	Conform
------	---------

Downloads

Approval/Certificate/Document of Conformity	EU Konformitätserklärung / EU Declaration of Conformity
Engineering Data	EPLAN, WSCAD
Engineering Data	STEP

**D-SERIES DRI
DRI424730**

Weidmüller Interface GmbH & Co. KG
 Klingenbergstraße 26
 D-32758 Detmold
 Germany
 Fon: +49 5231 14-0
 Fax: +49 5231 14-292083
 www.weidmueller.com

Drawings

Wiring diagram

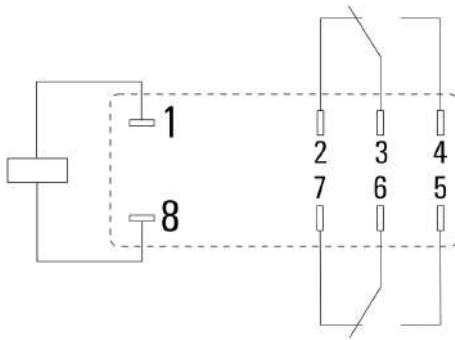

View of Pins from below

Graph

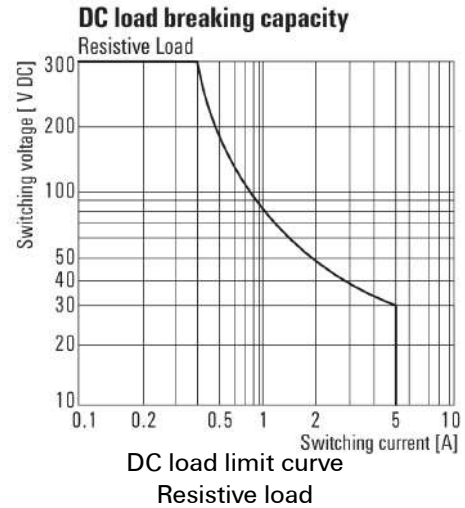

Graph

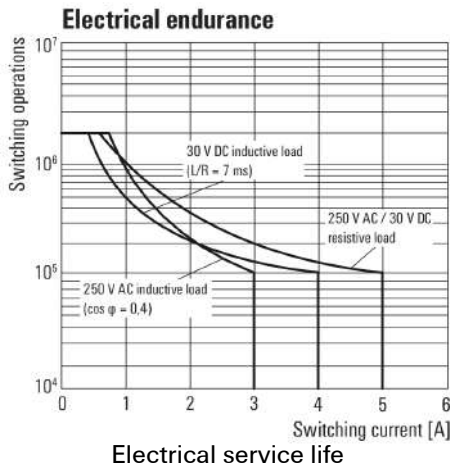

Graph

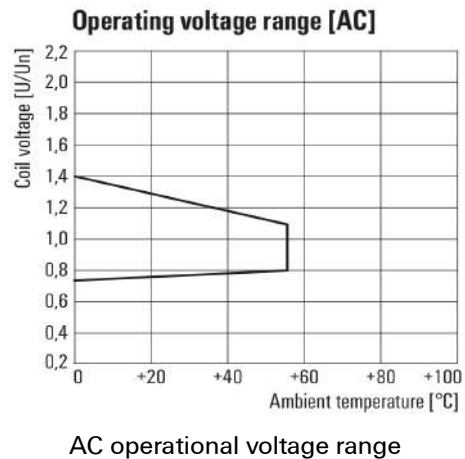

Dimensional drawing

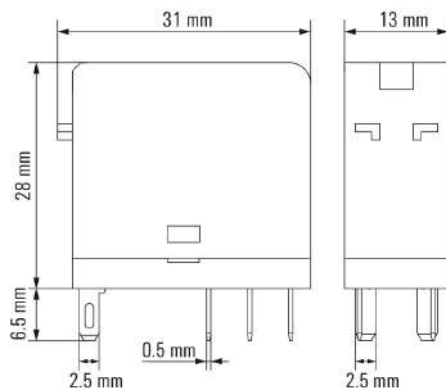

D-SERIES DRI DRI424730

Weidmüller Interface GmbH & Co. KG
 Klingenbergstraße 26
 D-32758 Detmold
 Germany
 Fon: +49 5231 14-0
 Fax: +49 5231 14-292083
 www.weidmueller.com

Mating connector (fully pluggable)

Base



Accessories for D-SERIES relays include:

- Relay bases
- LED / Protective modules
- Metal retaining clips

General ordering data

Type	SDI 2CO ECO	Version
Order No.	7760056347	D-SERIES DRI, Relay bases, Number of contacts: 2 CO contact,
GTIN (EAN)	6944169739941	Continuous current: 8 A, Screw connection
Qty.	10 pc(s).	
Type	SDI 2CO	Version
Order No.	7760056351	D-SERIES DRI, Relay bases, Number of contacts: 2 CO contact,
GTIN (EAN)	6944169739989	Continuous current: 8 A, Screw connection
Qty.	10 pc(s).	
Type	SDI 2CO P	Version
Order No.	7760056365	D-SERIES DRI, Relay bases, Number of contacts: 2 CO contact,
GTIN (EAN)	6944169772290	Continuous current: 8 A, PUSH IN with actuator
Qty.	20 pc(s).	
Type	SDI 2CO F ECO	Version
Order No.	7760056349	D-SERIES DRI, Relay bases, Number of contacts: 2 CO contact,
GTIN (EAN)	6944169739965	Continuous current: 8 A, Screw connection
Qty.	10 pc(s).	

D-SERIES DRI DRI424730

Weidmüller Interface GmbH & Co. KG
 Klingenbergstraße 26
 D-32758 Detmold
 Germany
 Fon: +49 5231 14-0
 Fax: +49 5231 14-292083
 www.weidmueller.com

Accessories

MultiCard

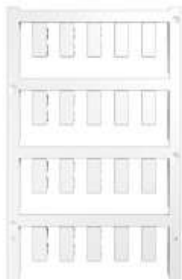

The Weidmüller device markers enable users to conform to obligatory equipment labelling regulations. Users can label the device markers themselves by means of suitable software and system-compatible printer systems. ESG is the tried-and-tested marker in MultiCard format. The result is high-quality device marking with a high-contrast appearance.

ESG 6/15 SDI MC... for marking D-SERIES DRI relay sockets:

- Attachable MultiCard markers
- Depending on the relay socket it is attachable on up to 4 levels
- Additional option for attaching the marker on plastic retaining clip: SDI CLIP P
- PrintJet printable

General ordering data

Type	ESG 6/15 SDI MC SDR	Version
Order No.	2558310000	ESG, Device markers x 15 mm, PA 66, Colour: To customer specification
GTIN (EAN)	4050118569025	
Qty.	40 pc(s).	

Type	ESG 6/15 SDI MC NE WS	Version
Order No.	2558340000	ESG, Device markers x 15 mm, PA 66, Colour: white
GTIN (EAN)	4050118569056	
Qty.	200 pc(s).	

Retaining clip



Accessories for D-SERIES relays include:

- Relay bases
- LED / Protective modules
- Metal retaining clips

General ordering data

Type	SDI CLIP LM	Version
Order No.	7760056368	D-SERIES DRI, Retaining clip
GTIN (EAN)	6944169773341	
Qty.	10 pc(s).	

Type	SDI CLIP P	Version
Order No.	7760056389	D-SERIES DRI, Retaining clip
GTIN (EAN)	6944169787539	
Qty.	10 pc(s).	

Data sheet

D-SERIES DRI DRI424730

Weidmüller Interface GmbH & Co. KG
 Klingenbergstraße 26
 D-32758 Detmold
 Germany
 Fon: +49 5231 14-0
 Fax: +49 5231 14-292083
 www.weidmueller.com

Accessories

Type	SDI CLIP	Version
Order No.	7760056352	D-SERIES DRI, Retaining clip
GTIN (EAN)	6944169739996	
Qty.	10 pc(s).	

LED



Accessories for D-SERIES relays include:

- Relay bases
- LED / Protective modules
- Metal retaining clips

General ordering data

Type	RIM 3 110/230VUC	Version
Order No.	7940018455	D-SERIES, LED module, Rated control voltage: 110...230 V UC, Plug-in connection
GTIN (EAN)	4032248878185	
Qty.	20 pc(s).	

Base



Accessories for D-SERIES relays include:

- Relay bases
- LED / Protective modules
- Metal retaining clips

General ordering data

Type	SDI 2CO ECO	Version
Order No.	7760056347	D-SERIES DRI, Relay bases, Number of contacts: 2 CO contact, Continuous current: 8 A, Screw connection
GTIN (EAN)	6944169739941	
Qty.	10 pc(s).	
Type	SDI 2CO	Version
Order No.	7760056351	D-SERIES DRI, Relay bases, Number of contacts: 2 CO contact, Continuous current: 8 A, Screw connection
GTIN (EAN)	6944169739989	
Qty.	10 pc(s).	
Type	SDI 2CO P	Version
Order No.	7760056365	D-SERIES DRI, Relay bases, Number of contacts: 2 CO contact, Continuous current: 8 A, PUSH IN with actuator
GTIN (EAN)	6944169772290	
Qty.	20 pc(s).	

Data sheet

**D-SERIES DRI
DRI424730**

Weidmüller Interface GmbH & Co. KG
 Klingenbergstraße 26
 D-32758 Detmold
 Germany
 Fon: +49 5231 14-0
 Fax: +49 5231 14-292083
 www.weidmueller.com

Accessories

Type	SDI 2CO F ECO	Version
Order No.	7760056349	D-SERIES DRI, Relay bases, Number of contacts: 2 CO contact,
GTIN (EAN)	6944169739965	Continuous current: 8 A, Screw connection
Qty.	10 pc(s).	

Protection modules



Accessories for D-SERIES relays include:

- Relay bases
- LED / Protective modules
- Metal retaining clips

General ordering data

Type	RIM 3 110/230VAC LED	Version
Order No.	7760056045	D-SERIES, RC filter, Rated control voltage: 110...230 V AC, Plug-in connection
GTIN (EAN)	4032248878147	
Qty.	10 pc(s).	
Type	RIM 3 110/230VAC	Version
Order No.	7760056014	D-SERIES, RC filter, Rated control voltage: 110...230 V AC, Plug-in connection
GTIN (EAN)	4032248878109	
Qty.	10 pc(s).	

Data sheet

**D-SERIES DRI
DRI424730**

Weidmüller Interface GmbH & Co. KG
 Klingenbergstraße 26
 D-32758 Detmold
 Germany
 Fon: +49 5231 14-0
 Fax: +49 5231 14-292083
 www.weidmueller.com

Drawings

Miscellaneous

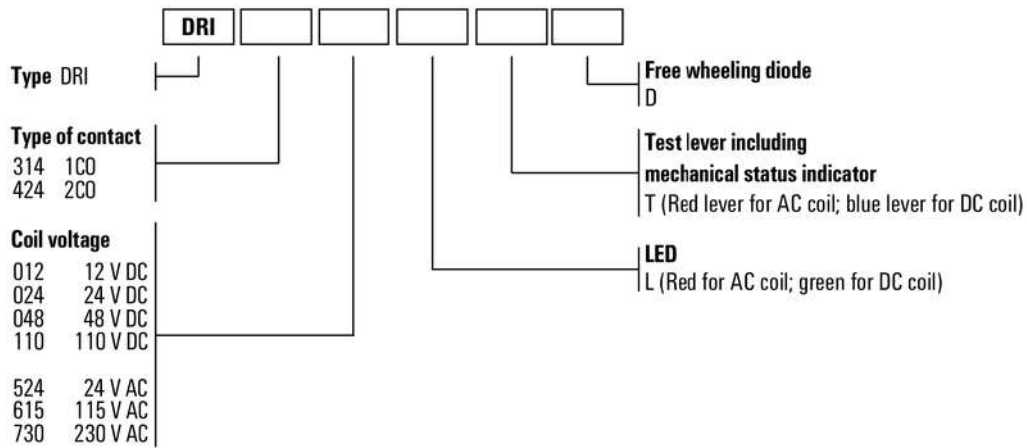

Type codes