

General-purpose Relay

LY

A Miniature Power Relay





- Equipped with arc barrier.
- Withstand voltage: 2,000 V.







RC+Y LR

Ordering Information

■ Open Relays

Type	Contact form	Plug-in/solder terminals 	Plug-in/solder terminals with indicator 	PCB terminals 	Upper-mounting Plug-in/solder terminals 
Standard	SPDT	LY1	LY1N	LY1-0	LY1F
	DPDT	LY2	LY2N	LY2-0	LY2F
	DPDT (bifurcated)	LY2Z	LY2ZN	LY2Z-0	LY2ZF
	3PDT	LY3	LY3N	LY3-0	LY3F
	4PDT	LY4	LY4N	LY4-0	LY4F
	4PDT (bifurcated)	LY4Z	LY4ZN	LY4Z-0	LY4ZF
With built-in diode (DC only)	SPDT	LY1-D	LY1N-D2	—	—
	DPDT	LY1-D	LY2N-D2	—	—
	DPDT (bifurcated)	LY2Z-D	LY2ZN-D2	—	—
	3PDT	LY3-D	—	—	—
	4PDT	LY4-D	LY4N-D2	—	—
	4PDT (bifurcated)	LY4Z-D	—	—	—
With built-in CR (AC only)	SPDT	—	—	—	—
	DPDT	LY2-CR	LY2N-CR	—	—
	DPDT (bifurcated)	LY2Z-CR	LY2ZN-CR	—	—
With built-in varister (AC only)	3PDT	—	—	—	—
	4PDT	LY4-Y-V	LY4N-V	—	—
	4PDT (bifurcated)	—	—	—	—

Type	Contact form	Plug-in/solder terminals	Plug-in/solder terminals with indicator	PCB terminals	Upper-mounting Plug-in/solder terminals
					
High-humidity	SPDT	LY1-TU	—	—	—
	DPDT	LY2-TU	—	—	—
	DPDT (bifurcated)	LY2Z-TU	—	—	—
	3PDT	LY3-TU	—	—	—
	4PDT	LY4-TU	—	—	—
	4PDT (bifurcated)	LY4Z-TU	—	—	—
With test button	SPDT	—	—	—	—
	DPDT	LY2I2	LY2I2N	—	—
	DPDT (bifurcated)	LY2ZI2	LY2ZI2N	—	—
	3PDT	LY3I2	—	—	—
	4PDT	LY4I2	LY4I2N	—	—
	4PDT (bifurcated)	LY4ZI2	LY4ZI2	—	—

Note: 1. When ordering, add the rated coil voltage to the model number. Rated coil voltages are given in the coil ratings table.

Example: LY2, 6 VAC

Rated coil voltage

2. Relays with #187 quick connect terminals are also available with SPDT and DPDT contact. Ask you OMRON representative for details.
3. SEV models are standard relays only. Relays with built-in varistors have not met overseas standards.
4. VDE- or LR- qualifying relays must be specified when ordering.

■ Accessories (Order Separately)

Sockets

Poles	Front-connecting socket	Back-connecting socket		
	DIN rail/screw terminals	Solder terminals	Wrapping terminals	PCB terminals
1 or 2	PTF08A-E, PTF08A	PT08	PT08QN	PT08-0
3	PTF11A	PT11	PT11QN	PT11-0
4	PTF14A-E, PTF14A	PT14	PT14QN	PT14-0

Note: 1. For PTF08-E and PTF14A-E, see "Track Mounted Socket".

2. PTF□AY (-E) sockets have met UL and CSA standards: UL 508/CSA C22.2.

Mounting Plates for Sockets

Socket model	For 1 socket	For 10 sockets	For 12 sockets	For 18 sockets
PT08 PT08QN	PYP-1	—	—	PYP-18
PT11 PT11QN	PTP-1-3	—	PTP-12	—
PT14 PT14QN	PTP-1	PTP-10	—	—

Socket-Hold-down Clip Pairings

Relay type	Poles	Front-connecting sockets		Back-connecting sockets	
		Socket model	Clip model	Socket model	Clip model
Standard, bifurcated contacts operation indicator, built-in diode, or high-humidity	1, 2	PTF08A-E, PTF08A	PYC-A1	PT08(QN), PT08-0	PYC-P
	3	PTF11A		PT11(QN), PT11-0	
	4	PTF14A-E, PTF14A		PT14(QN), PT14-0	
LY2N-D4	2	PTF08A-E, PTF08A	Y92H-3	PT08(QN), PT08-0	PYC-1
Test button	1, 2	PTF08A-E, PTF08A	PYC-A1	PT08(QN), PT08-0	PYC-P2
	3	PTF11A		PT11(QN), PT11-0	PYC-P (PYC-P2 for LY31)
	4	PTF14A-E, PTF14A		PT14(QN), PT14-0	PYC-P2
CR circuit	1, 2	PTF08A-E, PTF08A	Y92H-3	PT08(QN), PT08-0	PYC-1
Built-in varister	4	PTF14A-E, PTF14A	PYC-A1	PT14(QN), PT14-0	PYC-P

Specifications

■ Coil Ratings

Single- and Double-pole Relays

	Rated voltage	Rated current		Coil resistance	Inductance (reference value)		Must operate voltage	Must release voltage	Max. voltage	Power consum. (approx.)
		50 Hz	60 Hz		Arm. OFF	Arm. ON				
AC	6 V	214.1 mA	183 mA	12.2 Ω	0.04 H	0.08 H	80% max.	30% min.	110%	1.0 to 1.2 VA (60 Hz)
	12 V	106.5 mA	91 mA	46 Ω	0.17 H	0.33 H				
	24 V	53.8 mA	46 mA	180 Ω	0.69 H	1.30 H				
	50 V	25.7 mA	22 mA	788 Ω	3.22 H	5.66 H				
	100/110 V	11.7/12.9 mA	10/11 mA	3,750 Ω	14.54 H	24.6 H				
	110/120 V	9.9/10.8 mA	8.4/9.2 mA	4,430 Ω	19.20 H	32.1 H				
	200/220 V	6.2/6.8 mA	5.3/5.8 mA	12,950 Ω	54.75 H	94.07 H				
220/240 V	4.8/5.3 mA	4.2/4.6 mA	18,790 Ω	83.50 H	136.40 H					
DC	6 V	150 mA		40 Ω	0.16 H	0.33 H	10% min.		0.9 W	
	12 V	75 mA		160 Ω	0.73 H	1.37 H				
	24 V	36.9 mA		650 Ω	3.20 H	5.72 H				
	48 V	18.5 mA		2,600 Ω	10.6 H	21.0 H				
	100/110 V	9.1/10 mA		11,000 Ω	45.6 H	86.2 H				

Note: See notes on the bottom of next page.

Three-pole Relays

Rated voltage		Rated current		Coil resistance	Inductance (reference value)		Must operate voltage	Must release voltage	Max. voltage	Power consum. (approx)
		50 Hz	60 Hz		Arm. OFF	Arm. ON				
AC	6 V	310 mA	270 mA	6.7 Ω	0.03 H	0.05 H	80% max.	30% min.	110%	1.6 to 2.0 VA (60 Hz)
	12 V	159 mA	134 mA	24 Ω	0.12 H	0.21 H				
	24 V	80 mA	67 mA	100 Ω	0.44 H	0.79 H				
	50 V	38 mA	33 mA	410 Ω	2.24 H	3.87 H				
	100/110 V	14.1/16 mA	12.4/13.7 mA	2,300 Ω	10.5 H	18.5 H				
	200/220 V	9.0/10.0 mA	7.7/8.5 mA	8,650 Ω	34.8 H	59.5 H				
DC	6 V	234 mA		25.7 Ω	0.11 H	0.21 H	10% min.		1.4 W	
	12 V	112 mA		107 Ω	0.45 H	0.98 H				
	24 V	58.6 mA		410 Ω	1.89 H	3.87 H				
	48 V	28.2 mA		1,700 Ω	8.53 H	13.9 H				
	100/110 V	12.7/13 mA		8,500 Ω	29.6 H	54.3 H				

Note: See notes under next table.

Four-pole Relays

Rated voltage		Rated current		Coil resistance	Inductance (reference value)		Must operate voltage	Must release voltage	Max. voltage	Power consum. (approx)
		50 Hz	60 Hz		Arm. OFF	Arm. ON				
AC	6 V	386 mA	330 mA	5 Ω	0.02 H	0.04 H	80% max.	30% min.	110%	1.95 to 2.5 VA (60 Hz)
	12 V	199 mA	170 mA	20 Ω	0.10 H	0.17 H				
	24 V	93.6 mA	80 mA	78 Ω	0.38 H	0.67 H				
	50 V	46.8 mA	40 mA	350 Ω	1.74 H	2.88 H				
	100/110 V	22.5/25.5 mA	19/21.8 mA	1,600 Ω	10.5 H	17.3 H				
	200/220 V	11.5/13.1 mA	9.8/11.2 mA	6,700 Ω	33.1 H	57.9 H				
DC	6 V	240 mA		25 Ω	0.09 H	0.21 H	10% min.		1.5 W	
	12 V	120 mA		100 Ω	0.39 H	0.84 H				
	24 V	69 mA		350 Ω	1.41 H	2.91 H				
	48 V	30 mA		1,600 Ω	6.39 H	13.6 H				
	100/110 V	15/15.9 mA		6,900 Ω	32 H	63.7 H				

- Note:
1. The rated current and coil resistance are measured at a coil temperature of 23°C with tolerances of +15%/-20% for rated currents and ±15% for DC coil resistance.
 2. Performance characteristic data are measured at a coil temperatures of 23°C.
 3. AC coil resistance and impedance are provided as reference values (at 60 Hz).
 4. Power consumption drop was measured for the above data. When driving transistors, check leakage current and connect a bleeder resistor if required.

■ Contact Ratings

Relay	Single contact				Bifurcated contacts	
	1-pole		2-, 3- or 4-pole			
Load	Resistive load ($\cos\phi = 1$)	Inductive load ($\cos\phi=0.4$, L/R=7 ms)	Resistive load ($\cos\phi = 1$)	Inductive load ($\cos\phi=0.4$, L/R=7 ms)	Resistive load ($\cos\phi = 1$)	Inductive load ($\cos\phi=0.4$, L/R=7 ms)
Rated load	100 VAC 15 A 24 VDC 15 A	110 VAC 10 A 24 VDC 7 A	110 VAC 10 A 24 VDC 10 A	110 VAC 7.5 A 24 VDC 5 A	110 VAC 5A 24 VDC 5 A	110 VAC 4 A 24 VDC 4A
Rated carry current	15 A		10 A		7 A	
Max. switching voltage	250 VAC 125 VDC		250 VAC 125 VDC		250 VAC 125 VDC	
Max. switching current	15 A		10 A		7 A	
Max. switching capacity	1,700 VA 360 W	1,100 VA 170 W	1,100 VA 240 W	825 VA 120 W	550 VA 120 W	440 VA 100 W
Min. permissible load*	100 mA, 5 VDC		100 mA, 5 VDC		10 mA, 5 VDC	

*Note: P level: $\lambda_{60} = 0.1 \times 10^{-6}$ /operation, reference value

■ Characteristics

Item	All but relays with bifurcated contacts	Relays with bifurcated contacts
Contact resistance	50 m Ω max.	
Operate time	25 ms max.	
Release time	25 ms max.	
Max. operating frequency	Mechanical: 18,000 operations/hr Electrical: 1,800 operations/hr (under rated load)	
Insulation resistance	100 M Ω min. (at 500 VDC)	
Dielectric withstand voltage	1,000 VAC, 50/60 Hz for 1 min between contacts of same polarity 2,000 VAC, 50/60 Hz for 1 min between contacts of different polarity	
Vibration resistance	Destruction: 10 to 55 Hz, 1.0-mm double amplitude Malfunction: 10 to 55 Hz, 1.0-mm double amplitude	
Shock resistance	Destruction: 1,000 m/s ² (approx. 100G) Malfunction: 200 m/s ² (approx. 20G)	
Life expectancy	Mechanical: AC: 50,000,000 operations min. (at 18,000 operations/hr) DC: 1,00,000,000 operations min. (at 18,000 operations/hr) Electrical: Single-, three-, and four-pole: 200,000 operations min. (at 1,800 operations/hr under rated load) Double-pole: 500,000 operations min. (at 1,800 operations/hr under rated load)	
Ambient operating temperature*	Single- and double-pole standard, bifurcated-contact, test-button, and high-humidity relays: -25°C to 55°C (with no icing) (-25°C to 70°C if carry current is 4 A or less) All other relays: -25°C to 40°C (with no icing) (-25°C to 55°C if carry current is 4 A or less)	
Ambient operating humidity	35% to 85% (35% to 90% for high-humidity relays)	
Weight	Single- and double-pole: approx. 40 g, three-pole: approx. 50 g, four-pole: approx. 70 g	

Note: 1. The values given above are initial values.

*2. The upper limit of 40°C for some relays is because of the relationship between diode junction temperature and the element used.

■ Life Expectancies Under Real Loads (reference only)

LY1

Rated voltage	Load type	Conditions	Operating frequency	Electrical life
100 VAC	AC motor	400 W, 100 VAC single-phase with 35-A inrush current, 7-A current flow	ON for 10 s, OFF for 50 s	50,000 operations
		750 W, 200 VAC triple-phase with 18-A inrush current, 3.5-A current flow		70,000 operations
	AC lamp	300 W, 100 VAC with 51-A inrush current, 3-A current flow	ON for 5 s, OFF for 55 s	100,000 operations
		500 W, 100 VAC with 78-A inrush current, 5-A current flow		25,000 operations
	Capacitor (2,000 μ F)	24 VDC with 50-A inrush current, 1-A current flow	ON for 1 s, OFF for 6 s	100,000 operations
	AC solenoid	50 VA with 2.5-A inrush current, 0.25-A current flow	ON for 1 s, OFF for 2 s	1,500,000 operations
100 VA with 5-A inrush current, 0.5-A current flow		800,000 operations		

LY2

Rated voltage	Load type	Conditions	Operating frequency	Electrical life
100 VAC	AC motor	400 W, 100 VAC single-phase with 25-A inrush current, 5-A current flow	ON for 10 s, OFF for 50 s	200,000 operations
		750 W, 200 VAC triple-phase with 18-A inrush current, 3.5-A current flow		70,000 operations
	AC lamp	300 W, 100 VAC with 51-A inrush current, 3-A current flow	ON for 5 s, OFF for 55 s	80,000 operations
		500 W, 100 VAC with 78-A inrush current, 5-A current flow		25,000 operations
	Capacitor (2,000 μ F)	24 VDC with 50-A inrush current, 1-A current flow	ON for 1 s, OFF for 15 s	10,000 operations
		24 VDC with 20-A inrush current, 1-A current flow		150,000 operations
AC solenoid	50 VA with 2.5-A inrush current, 0.25-A current flow	ON for 1 s, OFF for 2 s	1,000,000 operations	
	100 VA with 5-A inrush current, 0.5-A current flow		500,000 operations	

LY4

Rated voltage	Load type	Conditions	Operating frequency	Electrical life
100 VAC	AC motor	200 W, 200 VAC triple-phase with 5-A inrush current, 5-A current flow	ON for 10 s, OFF for 50 s	500,000 operations
		750 W, 200 VAC triple-phase with 18-A inrush current, 3.5-A current flow		70,000 operations
	AC lamp	300 W, 100 VAC with 51-A inrush current, 3-A current flow	ON for 5 s, OFF for 55 s	50,000 operations
		500 W, 100 VAC with 78-A inrush current, 5-A current flow		25,000 operations
	Capacitor (2,000 μ F)	24 VDC with 50-A inrush current, 1-A current flow	ON for 1 s, OFF for 15 s	5,000 operations
		24 VDC with 20-A inrush current, 1-A current flow	ON for 1 s, OFF for 2 s	200,000 operations
AC solenoid	50 VA with 2.5-A inrush current, 0.25-A current flow	ON for 1 s, OFF for 2 s	1,000,000 operations	
	100 VA with 5-A inrush current, 0.5-A current flow		500,000 operations	

■ Approved by Standards

UL 508 Recognitions (File No. 41643)

No. of poles	Coil ratings	Contact ratings
1	6 to 240 VAC 6 to 120 VDC	15 A, 28 VDC (resistive load) 15 A, 240 VAC (inductive load) TV-5 120 VAC 1/2 IP 120 VACHP rated
2		13 A, 120 VAC (resistive load) 10 A, 28 VDC (inductive load) 12 A 240 VAC (inductive load) TV-3 120 VAC 1/2 IP 120 VAC HP rated
3 and 4		10 A, 28 VDC (resistive load) 10 A, 240 VAC (inductive load) 1/3 IP 240 VAC HP rated

CSA 22.2 No. 0 and No.14 Listings (File No. LR31928)

No. of poles	Coil ratings	Contact ratings
1	240 VAC max. 120 VDC max.	15 A, 28 VDC (resistive load) 15 A, 120 VAC (inductive load) 10 A, 240 VAC (inductive load) TV-5 120 VAC
2	6 to 240 VAC 6 to 120 VDC	13 A, 28 VDC (resistive load) 12 A, 120 VAC (inductive load) 10 A, 240 VAC (inductive load) 1/3 IP 120 VAC HP rated
	240 VAC max. 120 VDC max.	TV-31 20 VAC
3 and 4	6 to 240 VAC 6 to 120 VDC	10 A, 28 VDC (resistive load) 10 A, 240 VAC (inductive load)

SEV Listings (File No. D3,31/137)

No. of poles	Coil ratings	Contact ratings
1	6 to 110 VDC 2 to 240 VAC	15 A, 24 VDC 15 A, 220 VAC
2 to 4	6 to 110 VDC 6 to 240 VDC	10 A, 24 VDC 10 A, 220 VAC

VDE Recognitions (No. 9903UG and 9947UG)

No. of poles	Coil ratings	Contact ratings
1	6, 12, 24, 50, 110, 220 VAC 6, 12, 24, 48, 110 VDC	10 A, 220 VAC (resistive load) 7 A, 220 VAC (inductive load) 10 A, 28 VDC (resistive load) 7 A, 28 VDC (inductive load)
2, 3 and 4		7 A, 220 VAC (resistive load) 4 A, 220 VAC (inductive load) 7 A, 28 VDC (resistive load) 7 A, 28 VDC (inductive load)

LR Recognitions (No. 562K0B-204523)

No. of poles	Coil ratings	Contact ratings
2	6 to 240 VAC	7.5 A, 230 VAC (inductive load)
4	6 to 110 VDC	5 A, 24 VDC (inductive load)

Engineering Data

LY1

Maximum Switching Capacity

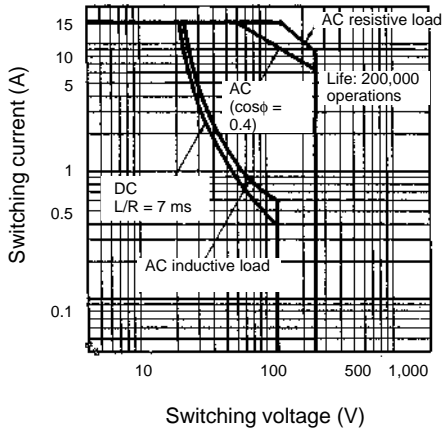

Life Expectancy

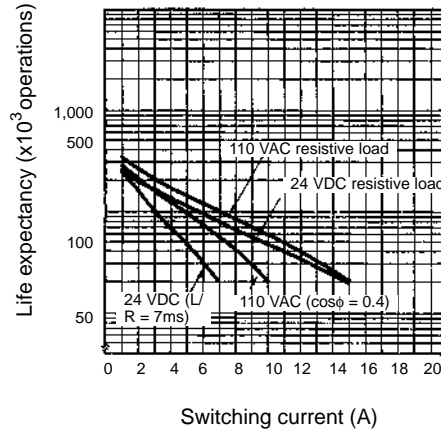

LY2

Maximum Switching Capacity

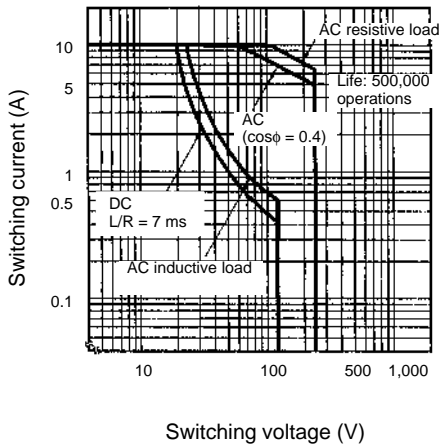

Life Expectancy

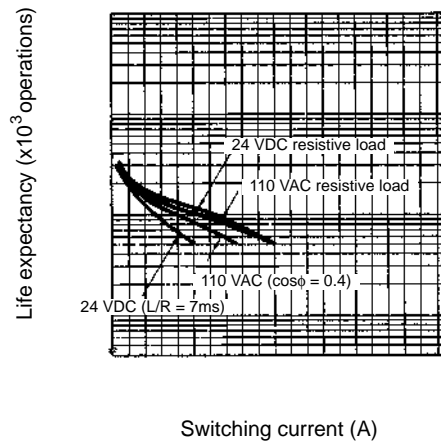

LY3 and LY4

Maximum Switching Capacity

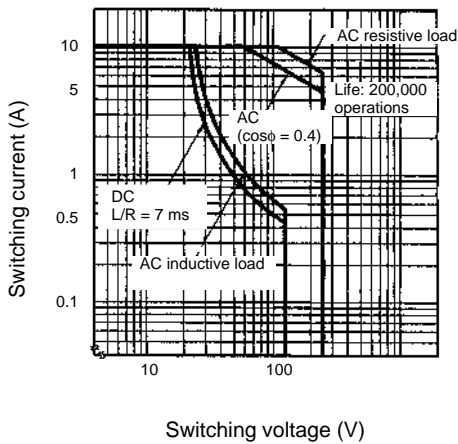

Life Expectancy

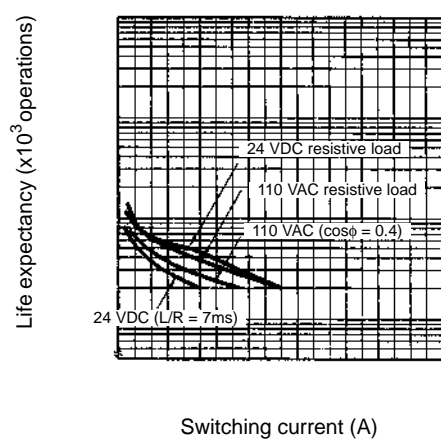

LY2Z and LY4Z
Maximum Switching Capacity

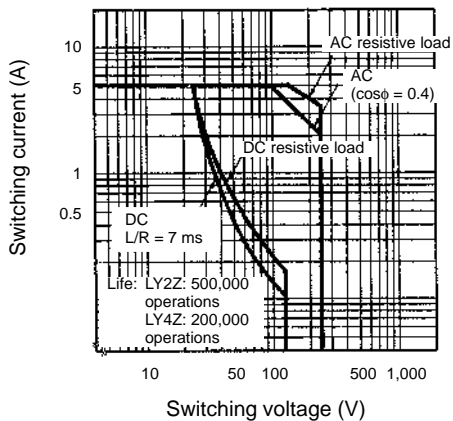

LY2Z
Life Expectancy

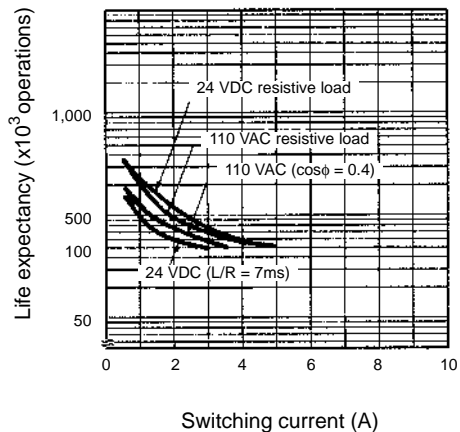

Dimensions

Note: All units are in millimeters unless otherwise indicated.

■ **Relays with Solder/Plug-in Terminals**

- LY1
- LY1N (-D2)
- LY1-D
- LY1-TU

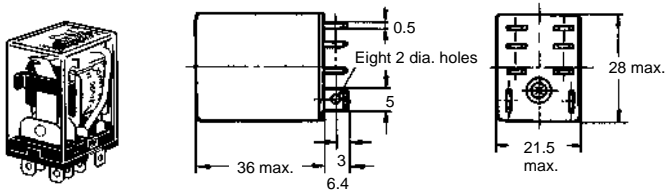

Terminal arrangement/internal connections (bottom view)

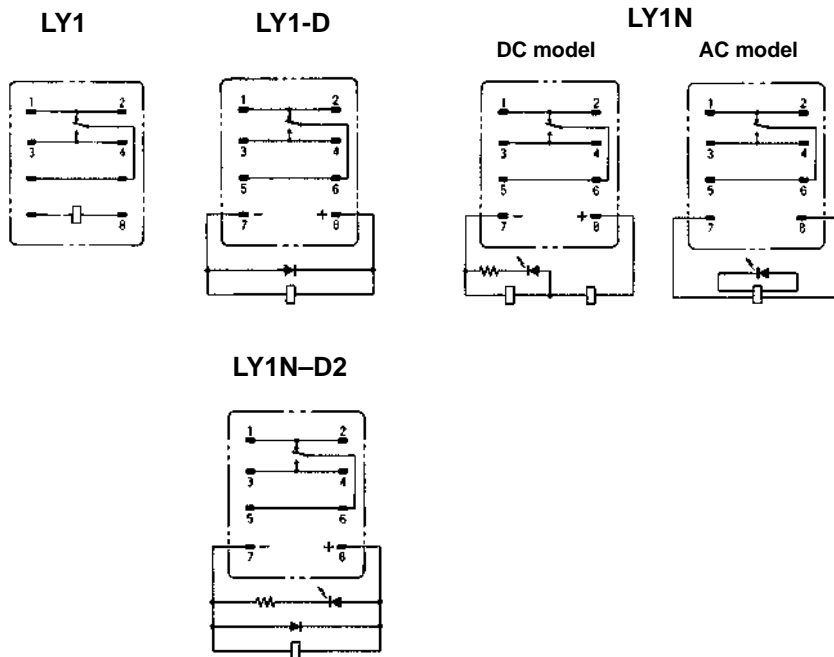

Note: The DC model has polarity.

- LY2
- LY2Z
- LY2N
- LY2ZN
- LY2-TU
- LY2-TU
- LY2Z-TU
- LY2-D
- LY2Z-D
- LY2N-D4
- LY2N-D2
- LY2N-D2
- LY2ZN-D2

Terminal arrangement/internal connections (bottom view)

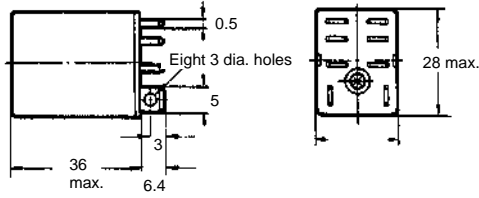
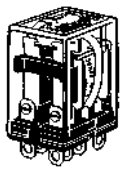

LY2(Z)

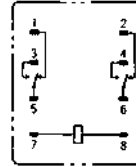

LY2(Z)-D

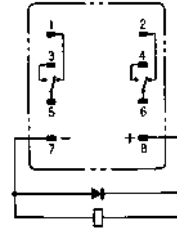

LY2(Z)N

DC model

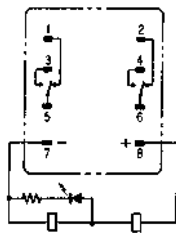

AC model

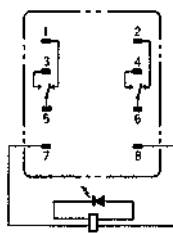

LY2(Z)N-D2

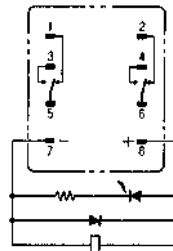

LY2N-D4

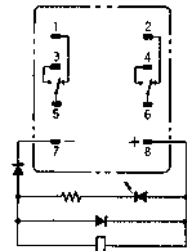

Note: The DC model has polarity.

- LY3
- LY3N
- LY3-D
- LY3-TU

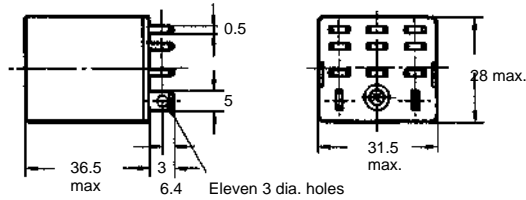
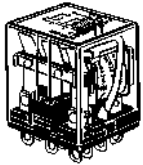

Terminal arrangement/internal connections (bottom view)

LY3

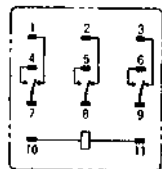

LY3-D

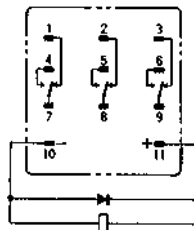

DC model

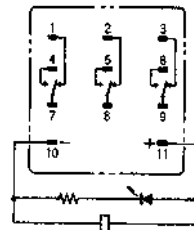

LY3N

AC model

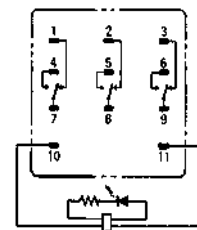

Note: The DC model has polarity.

LY4
LY4Z
LY4-D
LY4N-D

LY4N
LY4-V
LY4N-V

Terminal arrangement/internal connections
(bottom view)

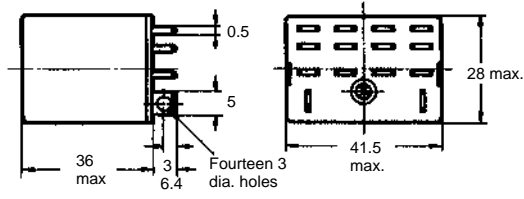
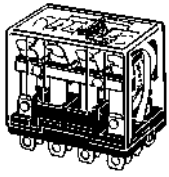

LY4(Z)

LY4(Z)-D

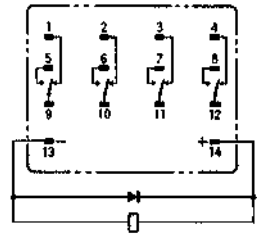
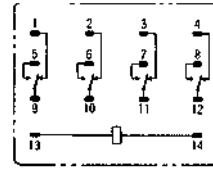

LY(Z)N

DC model

AC model

LY4-V

LY4N-V

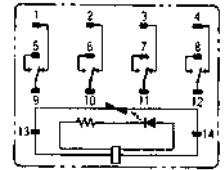
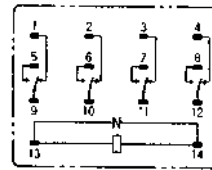
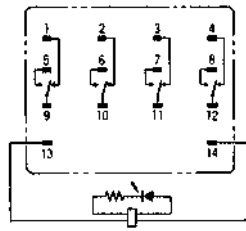
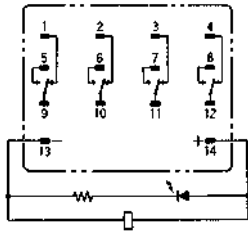

Note: The DC model has polarity.

LY2-CR
LY2Z-CR
LY2N-CR
LY2ZN-CR

Terminal arrangement/internal connections
(bottom view)

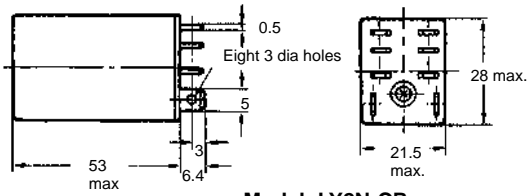

Model: LY2N-CR

LY2(Z)-CR

LY2(Z)N-CR

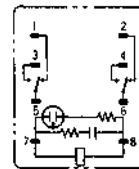
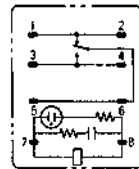

CR element

C: 0.033 μ F
R: 120 Ω

LY□(Z)I2(N)

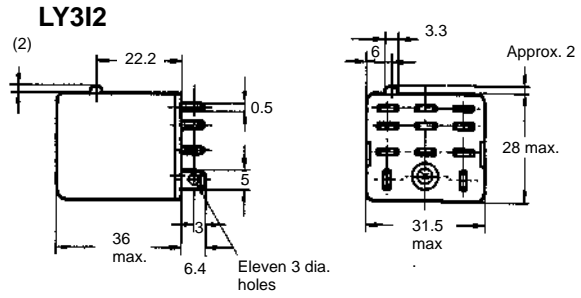
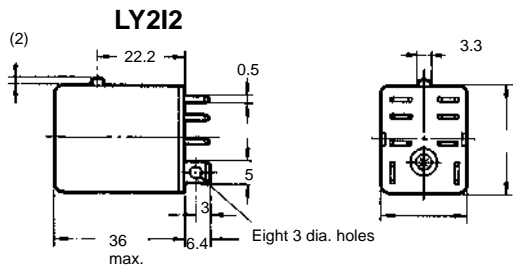

Note: The above dimensions are for the LY2I2 model.

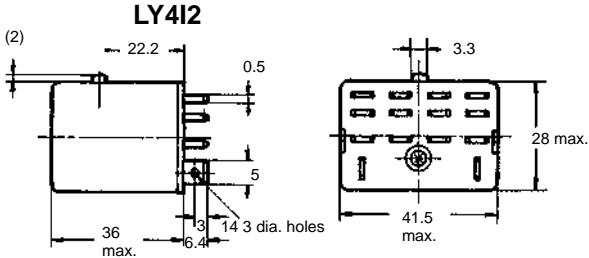

■ Relays with PCB Terminals

LY1-0 LY3-0
LY2-0 LY4-0

PC board holes (bottom view)

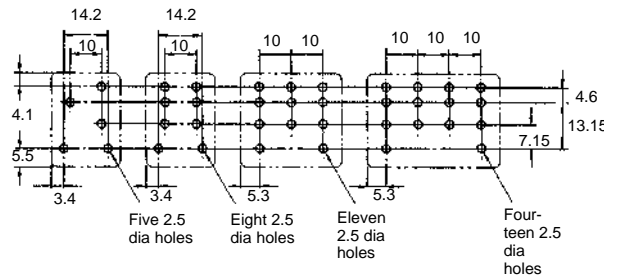
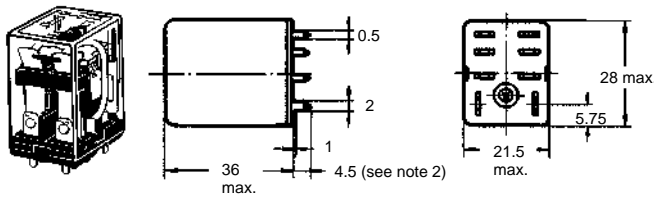

Note: 1. The above model is the LY2-0.
2. This figure is 6.4 for the LY1-0

Note: 1. The tolerance for the above figures is 0.1 mm.
2. Besides the terminals, some part of the LY1-0 carries current. Due attention should be paid when mounting the LY1-0 to a double-sided PC board.

■ Upper-mounting Relays

LY1F
LY2F

Mounting holes

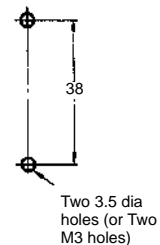
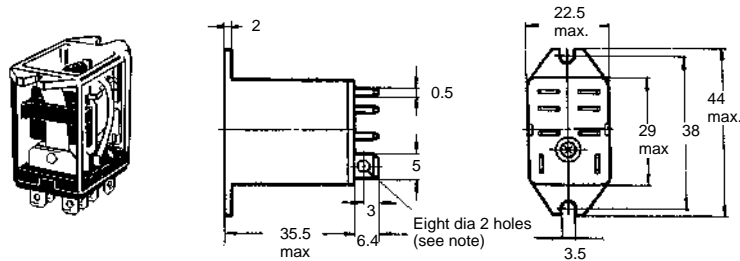

Note: 1. Eight 3 dia. holes should apply to the LY2F model.

Note: 1. The tolerance for the above figures is 0.1 mm.

LY3F

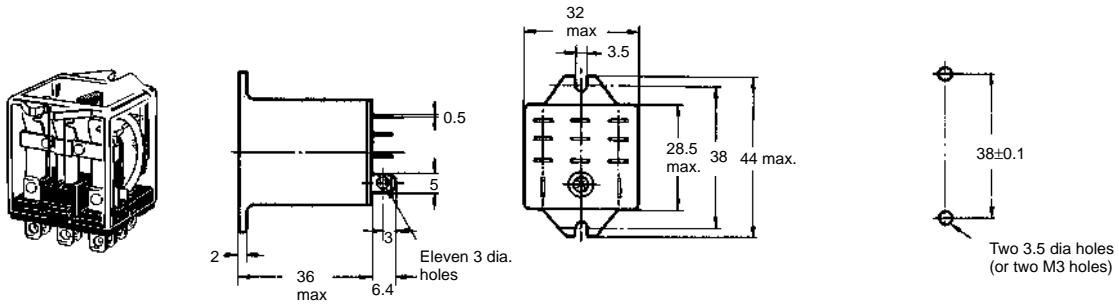

LY4F

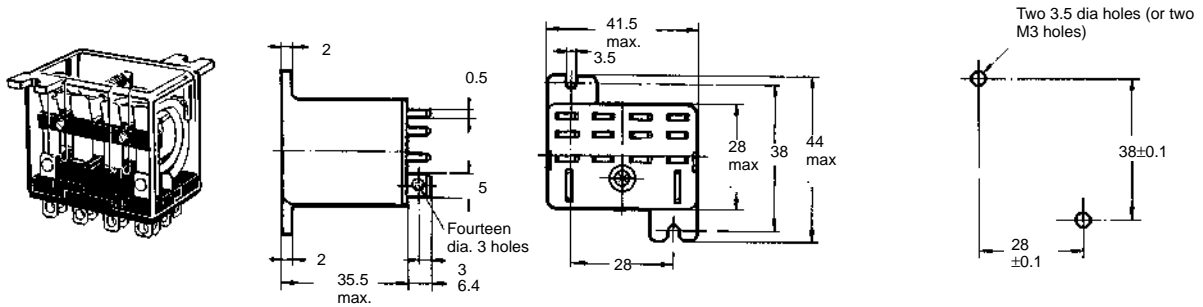

Mounting holes

■ Mounting Height with Socket

The following socket heights should be maintained.

Front connecting

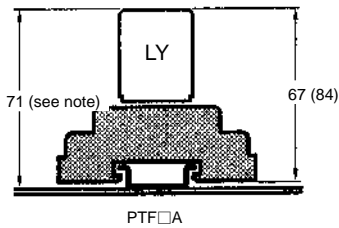

Back connecting

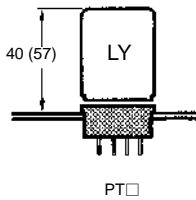

- Note:**
1. The PTF□A can be rail-mounted or screw-mounted.
 2. For the LY□-CR (CR circuit built-in type) model, this figure should be 88.

■ Sockets

PTF14A-E

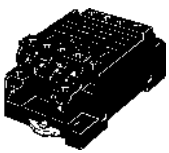

PT14

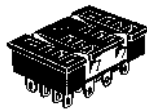



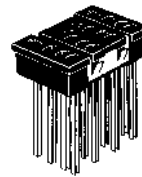

PT14QN

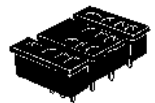

PT14-0

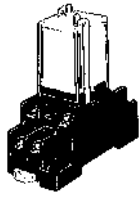

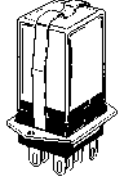
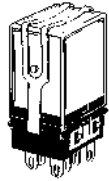
■ Hold-down Clips

Used with socket		Used with socket mounting plate	For test button built-in type relay	For CR circuit built-in relay	
<p>PYC-A1</p> 	<p>PYC-P</p> 	<p>PYC-S</p> 	<p>PYC-P2</p> 	<p>Y92H-3</p> 	<p>PYC-1</p> 

Precautions

■ Connections

Do not reverse polarity when connecting DC-operated relays with built-in diodes or indicators.