

POWER RELAY

2 POLES-2A High insulation/wide gap

FTR-C1 Series

■ FEATURES

- 2 Poles, 2 form C
- Contact gap: more than 0.6mm
- High surge voltage: 2,500V between open contacts
5,000V between coil & contact
Complies with Telcordia (former Bellcore) 2nd level surge
- Dielectric strength: 1,500VAC between open contacts
3,000VAC between coil and contact
- Dimensions of large contact gap relay
Height: 9.4mm maximum (THT)
9.7mm maximum (SMT)
Length: 15.2mm maximum
Width: 7.7mm maximum
- Conforms to IEC60950/ EN60950/UL1950/CSA C 22.2
No. 950 working voltage 250V (supplementary)
- High insulation: Clearance: min 2.0mm (coil and contacts)
Creepage: min 2.5mm (coil and contacts)
- Low power consumption 280mW (latching type 140mW)
- RoHS compliant. Please see page 9 for more information
- Plastic sealed



■ PARTNUMBER INFORMATION

[Example] FTR-C1 C A 012 G - B05
 (a) (b) (c) (d) (e) (f)

(a)	Relay type	FTR-C1	: FTR-C1-Series
(b)	Contact configuration	C G S	: Through hole type : Surface mount type : Surface mount type reduced mounting area
(c)	Coil type / enclosure	A B	: Standard type : Single coil latching type
(d)	Coil rated voltage	012	: 3.....24 VDC Coil rating table at page 3
(e)	Contact material	G	: Gold plated silver palladium
(f)	Tape / reel version	Nil B05	: Tube packing : Tape / reel packing, only available for SMT type

Actual marking does not carry the type name : "FTR"

E.g.: Ordering code: FTR-C1CA012G

Actual marking: C1CA012G

FTR-C1 SERIES

■ SPECIFICATION

Item		Non-latching FTR-C1 () A	Latching FTR-C1 () B	
Contact Data	Configuration	2 form C		
	Construction	Bifurcated		
	Material	Gold plated silver palladium		
	Resistance (Initial)	Max. 150mΩ at 1A, 6VDC		
	Contact rating resistive	1A, 30VDC / 0.3A, 125VAC		
	Max. Switching Voltage	250VAC / 220VDC		
	Max. Switching Power	62.5VA / 30W		
	Max. Carry Current	2A		
	Min. Switching Load *	0.01mA, 10mVDC		
Life	Mechanical	Min. 10 x 10 ⁶ operations		
	Electrical (resistive)	Min. 100 x 10 ³ operations at 0.3A, 125VAC / 1A, 30VD		
Coil Data	Rated Power	280 to 300mW	140 to 180mW	
	Operate Power	158 to 162mW	158 to 162mW	
	Pulse width	-	Min. 20ms	
	Operating temp range	-40°C to +85°C (no frost)		
	Storage temperature / humidity	-40°C to +85°C / 5% to 85% RH (no frost)		
Timing Data	Operate (at nominal voltage)	Max. 6ms (without bounce)		
	Release (at nominal voltage)	Max. 6ms (without bounce)		
Insulation	Resistance (Initial)	Min. 1,000MΩ at 500VDC		
	Dielectric strength	Open contacts	1,500VAC (50/60Hz) 1min	
		Adjacent contacts	1,500VAC (50/60Hz) 1min	
		Contacts to coil	3,000VAC (50/60Hz) 1min	
	Surge strength	Contacts to coil	5,000V, 2 x 10μs	
	Clearance	Open contacts	0.6mm	
		Adjacent contacts	1.0mm	
		Contacts to coil	2.0mm	
	Creepage	Open contacts	0.6mm	
		Adjacent contacts	1.0mm	
Contacts to coil		2.5mm		
Other	Vibration Resistance	Misoperation>1us	10 to 55 to 10 Hz single amplitude 1.65mm	
		Endurance	10 to 55 to 10 Hz single amplitude 2.5mm	
	Shock	Misoperation>1us	Min. 500m/s ² (11+/-1ms)	
		Endurance	Min. 1,000m/s ² (6+/-1ms)	
	Weight	Approximately 2g		
Sealing	RT III (plastic sealed)			

* Minimum switching loads mentioned above are reference values. Please perform the confirmation test with actual load before production since reference values may vary according to switching frequencies, environmental conditions and expected reliability levels.

■ COIL RATING

Standard type

Coil Code	Rated Coil Voltage (VDC)	Coil Resistance +/- 10% (Ohm)	Must Operate Voltage (VDC) *	Must Release Voltage (VDC) *	Nominal Coil Power (mW)
003	3	32.1	2.25	0.3	280
4.5	4.5	72.3	3.38	0.45	
005	5	89.3	3.75	0.5	
012	12	514	9	1.2	
024	24	1,920	18	2.4	300

Latching type

Coil Code	Rated Coil Voltage (VDC)	Coil Resistance +/- 10% (Ohm)	Set Voltage (VDC) *	Reset Voltage (VDC) *	Nominal Coil Power (mW)
003	3	64.0	+2.25	- 2.25	140
4.5	4.5	145	+3.38	- 3.38	
005	5	179	+3.75	- 3.75	
012	12	1,029	+9	- 9	
024	24	3,200	+18	- 18	180

Note: All values in the table are valid for 20°C and zero contact current.

* Specified operate values are valid for pulse wave voltage.

Note: Please use at rated coil voltage. Please perform the confirmation test with actual conditions.

■ SAFETY STANDARDS

Type	Compliance	Contact rating
UL	UL 508	Flammability: UL 94-V0 (plastics)
	E63615	0.3A, 125 VAC (general use) (UL) 0.5A, 125VAC (CSA)
CSA	C22.2 No. 14 LR 40304	2A, 30VDC (general use) 0.3A, 110VDC (general use)

Comply with Telcordia specifications and meet BSI
Marking only for UL, CSA

CHARACTERISTIC DATA

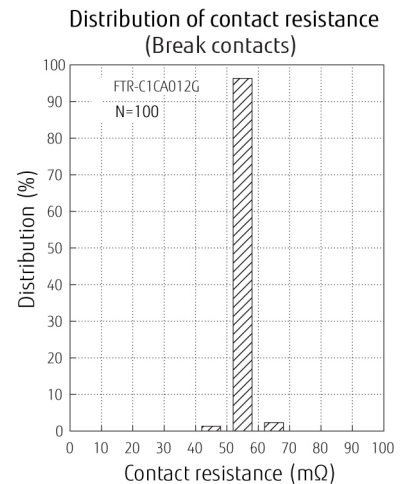
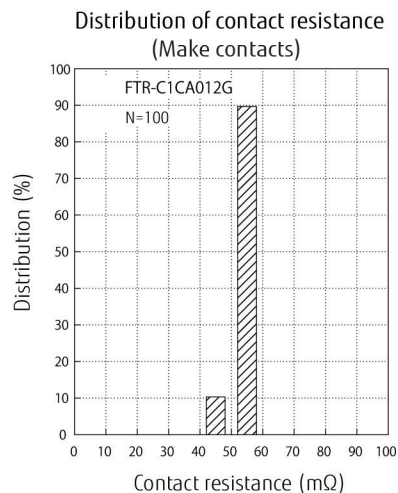
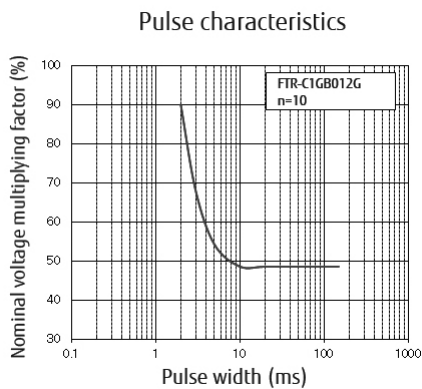
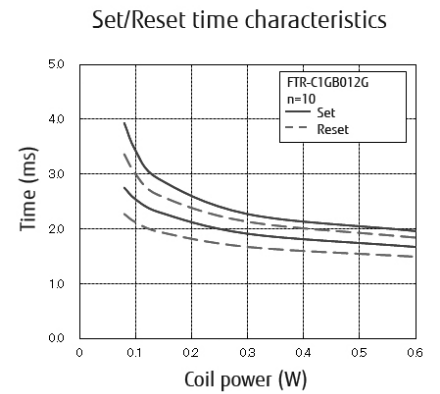
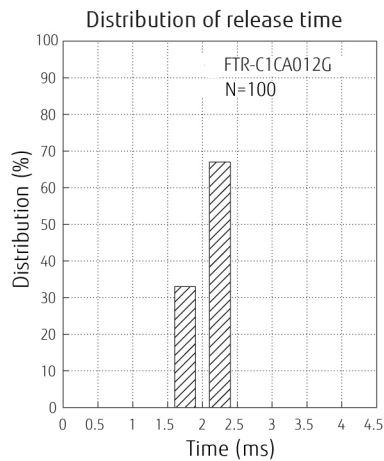
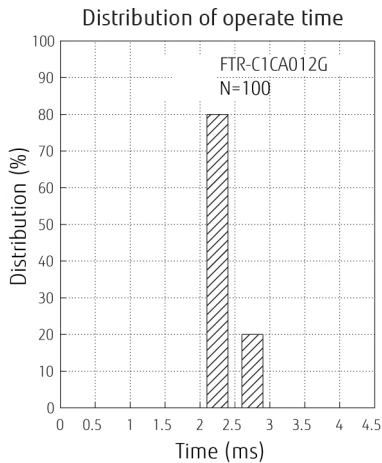
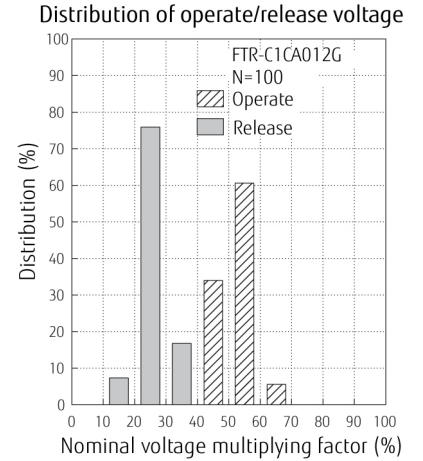
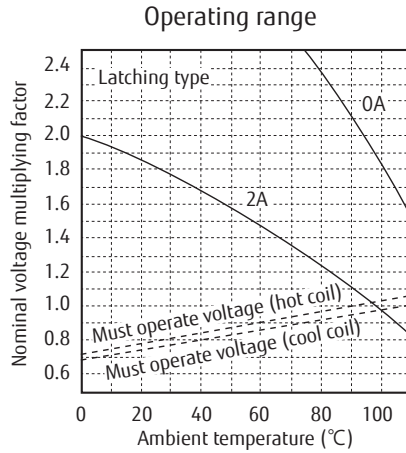
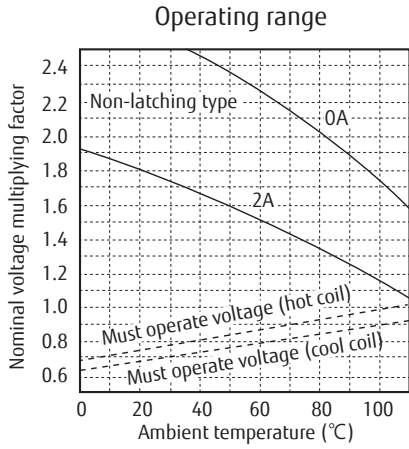

FTR-C1 SERIES

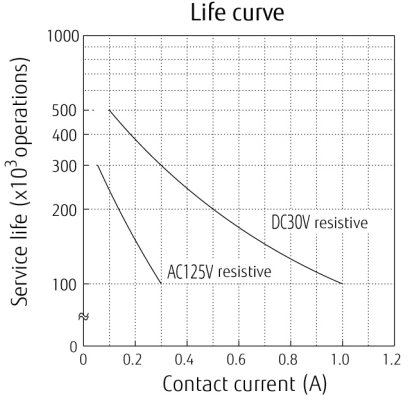
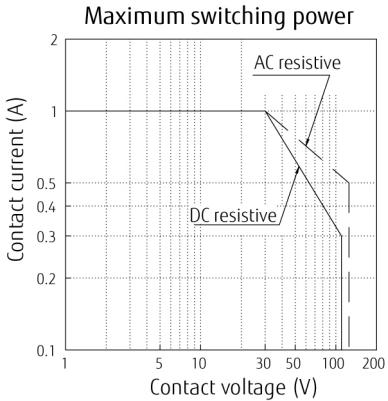

■ DIMENSIONS

Through hole type

● Dimensions

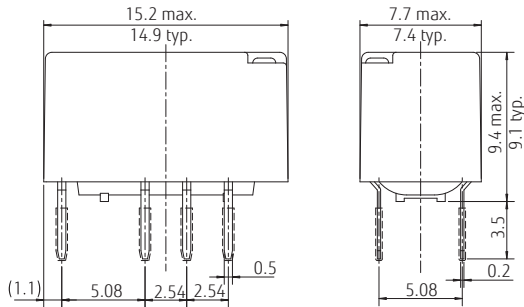

● Schematics (BOTTOM VIEW)

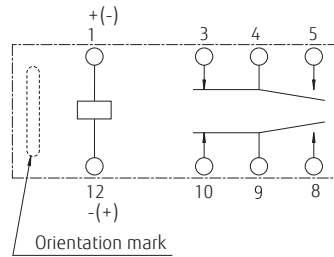

● Recommended PCB layout (BOTTOM VIEW)

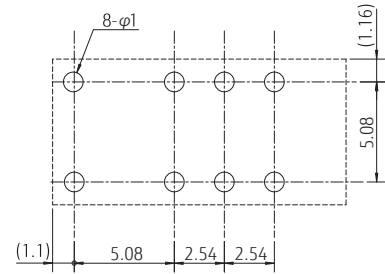

Surface mount type

● Dimensions

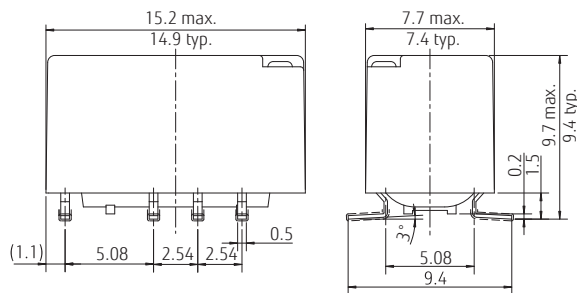

● Schematics (TOP VIEW)

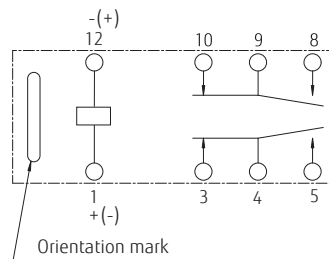

● Recommended PCB layout (TOP VIEW)

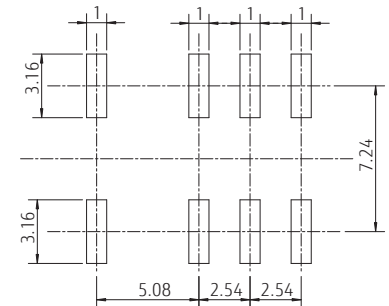

Surface mount (space saving) type

● Dimensions

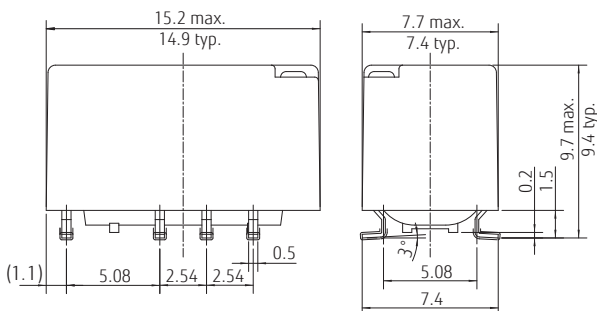

● Schematics (TOP VIEW)

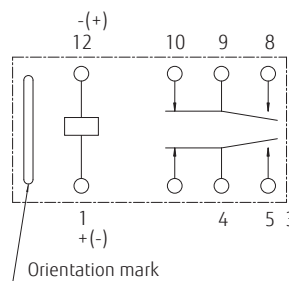

● Recommended PCB layout (TOP VIEW)

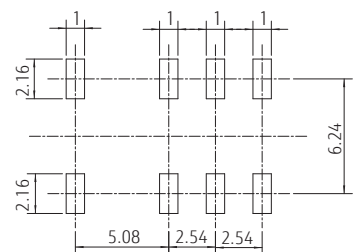

Note: (...) : dimensions are reference

Note: Dimensions of the terminals do not include thickness of pre-solder.

Note: Dimensions do not include tolerances. Please ask specification in case you need tolerances.

Note: Tolerance of PCB layout : ± 0.1 unless otherwise specified.

Unit: mm

RECOMMENDED SOLDERING CONDITIONS SMT

(TEMPERATURE PROFILE, please see page 9)

- Note:
1. Temperature profiles show the temperature of PC board surface.
 2. Please perform soldering test with your actual PC board before mass production, since the temperatures of PC board surfaces vary according to the size of PC board, status of parts mounting and heating method.

TAPE & REEL PACKAGING SPECIFICATION

1. Taping standards: JIS C 0806 and RC-10092B (EIA)
2. Tape type: TB2416 or TE2416
3. Reel type: RD24D
4. Quantity of 1 reel: 500 pieces

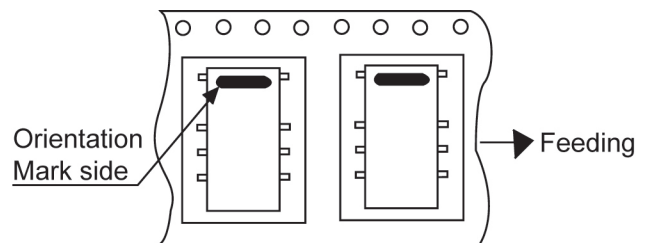

Tape Dimensions:

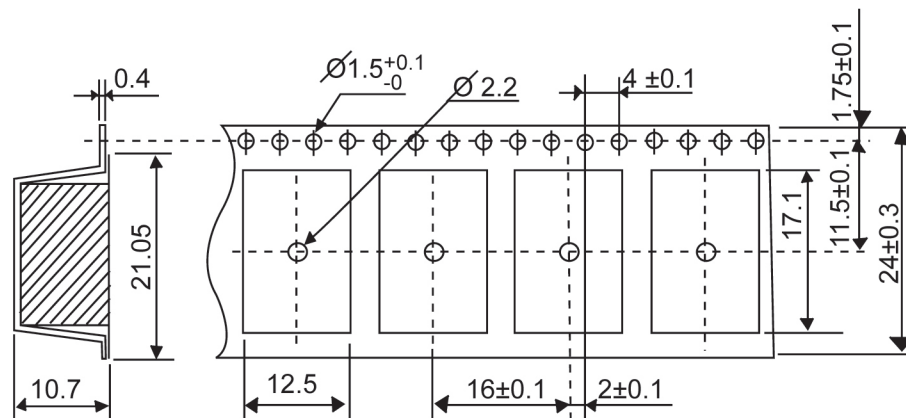

Reel Dimensions:

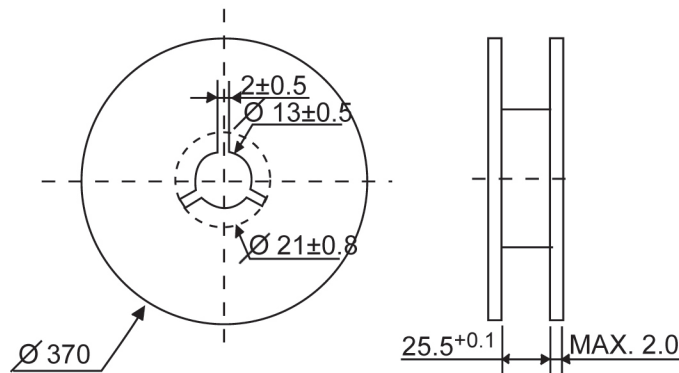

Unit: mm

RoHS Compliance and Lead Free Information

1. General Information

- All relays produced by Fujitsu Components are compliant with RoHS directive 2011/65/EU including amendments.
- Cadmium as used in electrical contacts is exempted from the RoHS directives.
As per Annex III of directive 2011/65/EU.
- All relays are lead-free. Please refer to Lead-Free Status Info for older date codes at:
<http://www.fujitsu.com/downloads/MICRO/fcai/relays/lead-free-letter.pdf>
- Lead free solder plating on relay terminals is Sn-3.0Ag-0.5Cu, unless otherwise specified.
This material has been verified to be compatible with PbSn assembly process.
- Characteristic data is not guaranteed values but measured values of samples from production line.

2. Recommended Lead Free Solder Condition

- Recommended solder Sn-3.0Ag-0.5Cu.

Reflow Solder condition for SMT

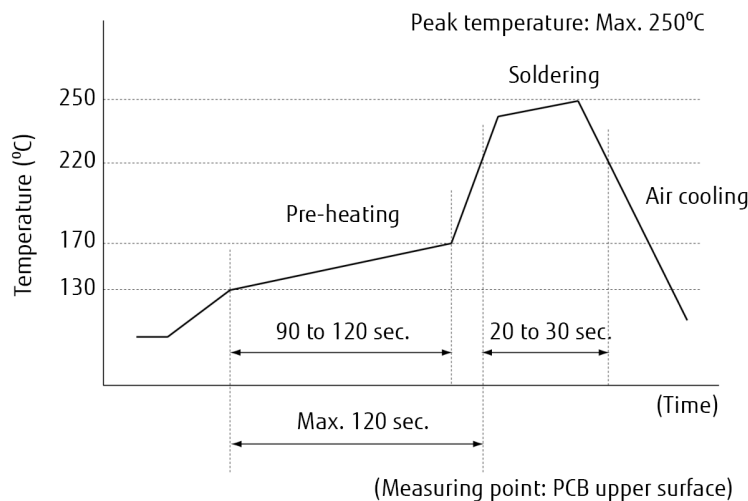

Flow Solder Condition:

Pre-heating: maximum 120°C
within 90 sec.

Soldering: dip within 5 sec. at
255°C ± 5°C solder bath

Relay must be cooled by air immediately
after soldering

Solder by Soldering Iron:

Soldering Iron 30-60W

Temperature: maximum 340-360°C

Duration: maximum 3 sec.

REFLOW

Note:

1. Temperature profiles show the temperature of PC board surface.
2. Please perform soldering test with your actual PC board before mass production, since the temperatures of PC board surfaces can vary, depending on the size of PC board, status of partsmounting and heating method.

We highly recommend that you confirm your actual solder conditions

3. Moisture Sensitivity

- SMT versions of FTR-C1 relays in Tape & Reel package will be shipped in Moisture Barrier Bag (MBB).
- Moisture Sensitivity Level (MSL) of FTR-C1 relay is indicated on the packing caution label.
- Relays must be stored in the unopened MBB at storage conditions <40C/90%RH for a maximum 1 year
- SMT versions of FTR-C1 relays in tube packing will not be shipped in MBB. Therefore, these relays shall be dried by baking before reflow soldering process according to IPC/JEDEC J-STD-033.

4. Tin Whiskers

- Dipped SnAgCu solder is known as presenting a low risk to tin whisker development. No considerable length whisker was found by our in house test.

Cautions

- All values mentioned in this datasheet are provided under ideal conditions. Please perform the confirmation test before actual use.
- Do not use relays in the atmosphere with sulfide gas, chloride gas or nitric oxide. Contact resistance may increase.
- Do not use silicon or silicon-containing product or materials near relays. It may cause contact failure.

Notes for latching relay

- Latching relays are shipped in the state set, but state may change due to shock during transportation or mounting. Before using the relays, it is advisable to bring the relays in necessary state (set or reset) and program a circuit sequence. Otherwise, it will or will not operate simultaneously with power activation.
- Please connect relay coils according to specified polarity.
- Do not apply voltage to both set coil and reset coil at a time.

Fujitsu Components International Headquarter Offices

Japan FUJITSU COMPONENT LIMITED Shinagawa Seaside Park Tower 19F, 12-4, Higashi-shinagawa 4-chome, Shinagawa-ku, Tokyo, 140-0002, Japan Tel: (81-3) 3450-1682 Fax: (81-3) 3474-2385 Email: fcl-contact@cs.jp.fujitsu.com Web: www.fujitsu.com/jp/fcl/	Asia Pacific FUJITSU COMPONENTS ASIA, LTD. 102E Pasir Panjang Road #01-01 Citilink Warehouse Complex Singapore 118529 Tel: (65) 6375-8560 Fax: (65) 6273-3021 Email: fcal@sg.fujitsu.com Web: www.fujitsu.com/sg/products/devices/components	Korea FUJITSU COMPONENTS KOREA LIMITED Alpha Tower #403, 645 Samsyeong-dong, Bundang-gu, Seongnam-si, Gyeonggi-do, 13524 Korea Tel: (82) 31-708-7108 Fax: (82) 31-709-7108 Email: fcal@sg.fujitsu.com www.fujitsu.com/sg/products/devices/components/
North and South America FUJITSU COMPONENTS AMERICA, INC 2290 North First Street, Suite 212 San Jose, CA 95131, USA Tel: (1-408) 745-4900 Fax: (1-408) 745-4970 Email: components@us.fujitsu.com Web: us.fujitsu.com/components	China FUJITSU ELECTRONIC COMPONENTS (SHANGHAI) CO., LTD. Unit 4306, InterContinental Center 100 Yu Tong Road, Shanghai 200070, China Tel: (86-21) 3253 0998 Fax: (86-21) 3253 0997 Email: fcal@sg.fujitsu.com Web: www.fujitsu.com/sg/products/devices/components	
Europe FUJITSU COMPONENTS EUROPE B.V. Diamantlaan 25 2132 WV Hoofddorp Netherlands Tel: (31-23) 5560910 Fax: (31-23) 5560950 Email: info@fceu.fujitsu.com Web: www.fujitsu.com/uk/components	Hong Kong FUJITSU COMPONENTS HONG KONG CO., LTD Unit 506, Inter-Continental Plaza No.94 Granville Road, Tsim Sha Tsui, Kowloon, Hong Kong Tel: (852) 2881-8495 Tex: (852) 2894-9512 Email: fcal@sg.fujitsu.com Web: www.fujitsu.com/sg/products/devices/components/	

©2018 Fujitsu Components Europe B.V. All rights reserved. All trademarks or registered trademarks are the property of their respective owners.

The contents, data and information in this datasheet are provided by Fujitsu Component Ltd. as a service only to its user and only for general information purposes.

The use of the contents, data and information provided in this datasheet is at the users' own risk.

Fujitsu has assembled this datasheet with care and will endeavor to keep the contents, data and information correct, accurate, comprehensive, complete and up to date.

Fujitsu Components Europe B.V. and affiliated companies do however not accept any responsibility or liability on their behalf, nor on behalf of its employees, for any loss or damage, direct, indirect or consequential, with respect to this datasheet, its contents, data, and information and related graphics and the correctness, reliability, accuracy, comprehensiveness, usefulness, availability and completeness thereof.

Nor do Fujitsu Components Europe B.V. and affiliated companies accept on their behalf, nor on behalf of its employees, any responsibility or liability for any representation or warrant of any kind, express or implied, including warranties of any kind for merchantability or fitness for particular use, with respect to these datasheets, its contents, data, information and related graphics and the correctness, reliability, accuracy, comprehensiveness, usefulness, availability and completeness thereof. Rev. October 18th, 2018