

## 1 Form A Solid-State Relay

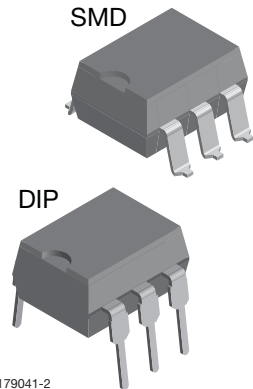

i179041-2

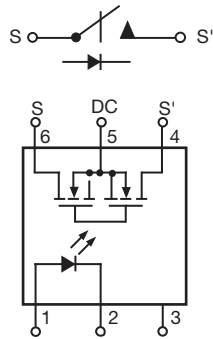

### FEATURES

- Extremely low operating current
- High speed operation
- Isolation test voltage 5300 V<sub>RMS</sub>
- Current limit protection
- High surge capability
- DC only option
- Clean bounce free switching
- Low power consumption
- Surface mountable
- Compliant to RoHS Directive 2002/95/EC and in accordance to WEEE 2002/96/EC



RoHS  
COMPLIANT

### DESCRIPTION

The LH1525 relay are SPST normally open switches (1 form A) that can replace electromechanical relays in many applications. The relay requires a minimal amount of LED drive current to operate, making it ideal for battery powered and power consumption sensitive applications. The relay is constructed using a GaAs LED for actuation control and an integrated monolithic die for the switch output. The die, fabricated in a high-voltage dielectrically isolated technology, comprised of a photodiode array, switch-control circuitry, and MOSFET switches. In addition, the relay employs current-limiting circuitry, enabling it to pass lightning surge testing as per ANSI/TIA-968-B and other regulatory surge requirements when overvoltage protection is provided. The relay can be configured for AC/DC or DC-only operation.

### APPLICATIONS

- General telecom switching
- Battery powered switch applications
- Industrial controls
- Programmable controllers
- Instrumentation

### Note

- See "solid-state relays" (application note 56)

### AGENCY APPROVALS

UL1577: file no. E52744 system code H, double protection  
 CSA: certification 093751  
 BSI: no. 7979/7980  
 FIMKO: 25419

ORDERING INFORMATION													
L	H	1	5	2	5	#	#	#	T	R			
PART NUMBER						ELECTR. VARIATION	PACKAGE CONFIG.			TAPE AND REEL		DIP 7.62 mm	SMD > 0.1 mm
<b>PACKAGE</b>						<b>UL, CSA, BSI, FIMKO</b>							
SMD-6, tubes						LH1525AAB							
SMD-6, tape and reel						LH1525AABTR							
DIP-6, tubes						LH1525AT							



ABSOLUTE MAXIMUM RATINGS ( $T_{amb} = 25\text{ }^{\circ}\text{C}$ , unless otherwise specified)				
PARAMETER	TEST CONDITION	SYMBOL	VALUE	UNIT
<b>INPUT</b>				
LED input ratings: continuous forward current		$I_F$	50	mA
LED input ratings: reverse voltage		$V_R$	8	V
<b>OUTPUT</b>				
Output operation (each channel): DC or peak AC load voltage	$I_L \leq 50\text{ }\mu\text{A}$	$V_L$	400	V
Continuous DC load current, bidirectional operation pin 4 to 6		$I_L$	125	mA
Continuous DC load current, unidirectional operation pins 4, 6 (+) to pin 5 (-)		$I_L$	250	mA
<b>SSR</b>				
Ambient operating temperature range		$T_{amb}$	- 40 to + 85	$^{\circ}\text{C}$
Storage temperature range		$T_{stg}$	- 40 to + 150	$^{\circ}\text{C}$
Pin soldering temperature <sup>(1)</sup>	$t = 10\text{ s max.}$	$T_{sld}$	260	$^{\circ}\text{C}$
Input to output isolation test voltage	$t = 1\text{ s}$	$V_{ISO}$	5300	$V_{RMS}$
Power dissipation		$P_{diss}$	550	mW

**Notes**

- Stresses in excess of the absolute maximum ratings can cause permanent damage to the device. Functional operation of the device is not implied at these or any other conditions in excess of those given in the operational sections of this document. Exposure to absolute maximum ratings for extended periods of the time can adversely affect reliability.
- <sup>(1)</sup> Refer to reflow profile for soldering conditions for surface mounted devices (SMD). Refer to wave profile for soldering conditions for through hole devices (DIP).

ELECTRICAL CHARACTERISTICS ( $T_{amb} = 25\text{ }^{\circ}\text{C}$ , unless otherwise specified)						
PARAMETER	TEST CONDITION	SYMBOL	MIN.	TYP.	MAX.	UNIT
<b>INPUT</b>						
LED forward current, switch turn-on	$I_L = 100\text{ mA}$ , $t = 10\text{ ms}$	$I_{Fon}$		0.33	0.5	mA
LED forward current, switch turn-off	$V_L = \pm 350\text{ V}$ , $t = 100\text{ ms}$	$I_{Foff}$	0.001	0.23		mA
LED forward voltage	$I_F = 1.5\text{ mA}$	$V_F$	0.8	1.16	1.40	V
<b>OUTPUT</b>						
On-resistance, AC/DC, each pole	$I_F = 1.5\text{ mA}$ , $I_L = \pm 50\text{ mA}$	$R_{ON}$	17	26	36	$\Omega$
On-resistance, DC: pin 4, 6 (+) to 5 (-)	$I_F = 1.5\text{ mA}$ , $I_L = 100\text{ mA}$	$R_{ON}$	4.25	7	8.25	$\Omega$
Off-resistance	$I_F = 0\text{ mA}$ , $V_L = \pm 100\text{ V}$	$R_{OFF}$		2000		$G\Omega$
Current limit AC <sup>(1)</sup> : pin 4 ( $\pm$ ) to 6 ( $\pm$ )	$I_F = 1.5\text{ mA}$ , $t = 5\text{ ms}$ , $V_L = 7\text{ V}$	$I_{LMT}$	170	185	270	mA
Off-state leakage current	$I_F = 0\text{ mA}$ , $V_L = \pm 100\text{ V}$	$I_O$		0.67	200	nA
	$I_F = 0\text{ mA}$ , $V_L = \pm 400\text{ V}$	$I_O$		0.096	1	$\mu\text{A}$
Output capacitance	$I_F = 0\text{ mA}$ , $V_L = 1\text{ V}$	$C_O$		22		pF
	$I_F = 0\text{ mA}$ , $V_L = 50\text{ V}$	$C_O$		6.42		pF
Switch offset	$I_F = 5\text{ mA}$	$V_{OS}$		0.2		$\mu\text{V}$
<b>TRANSFER</b>						
Capacitance (input to output)	$V_{ISO} = 1\text{ V}$	$C_{IO}$		0.75		pF

**Notes**

- Minimum and maximum values are testing requirements. Typical values are characteristics of the device and are the result of engineering evaluations. Typical values are for information only and are not part of the testing requirements.
- <sup>(1)</sup> No DC mode current limit available.

SWITCHING CHARACTERISTICS ( $T_{amb} = 25\text{ }^{\circ}\text{C}$ , unless otherwise specified)						
PARAMETER	TEST CONDITION	SYMBOL	MIN.	TYP.	MAX.	UNIT
Turn-on time	$I_F = 1.5\text{ mA}$ , $I_L = 50\text{ mA}$	$t_{on}$		1.25		ms
	$I_F = 5\text{ mA}$ , $I_L = 50\text{ mA}$	$t_{on}$		0.22	1	ms
Turn-off time	$I_F = 1.5\text{ mA}$ , $I_L = 50\text{ mA}$	$t_{off}$		0.6		ms
	$I_F = 5\text{ mA}$ , $I_L = 50\text{ mA}$	$t_{off}$		1.1	1.5	ms



SAFETY AND INSULATION RATINGS				
PARAMETER	TEST CONDITION	SYMBOL	VALUE	UNIT
Climatic classification	IEC 68 part 1		40/85/21	
Pollution degree	DIN VDE 0109		2	
Tracking resistance (comparative tracking index)	Insulation group IIIa	CTI	175	
Highest allowable overvoltage	Transient overvoltage	$V_{IOTM}$	8000	$V_{peak}$
Max. working insulation voltage	Recurring peak voltage	$V_{IORM}$	890	$V_{peak}$
Insulation resistance at 25 °C	$V_{IO} = 500 V$	$R_{IS}$	$\geq 10^{12}$	$\Omega$
Insulation resistance at $T_S$		$R_{IS}$	$\geq 10^9$	$\Omega$
Insulation resistance at 100 °C		$R_{IS}$	$\geq 10^{11}$	$\Omega$
Partial discharge test voltage	Methode a, $V_{pd} = V_{IORM} \times 1.875$	$V_{pd}$	1669	$V_{peak}$
Safety limiting values - maximum values allowed in the event of a failure	Case temperature	$T_{SI}$	175	°C
	Input current	$I_{SI}$	300	mA
	Output power	$P_{SO}$	700	mW
Minimum external air gap (clearance)	Measured from input terminals to output terminals, shortest distance through air		$\geq 7$	mm
Minimum external tracking (creepage)	Measured from input terminals to output terminals, shortest distance path along body		$\geq 7$	mm

**TYPICAL CHARACTERISTICS** ( $T_{amb} = 25\text{ °C}$ , unless otherwise specified)

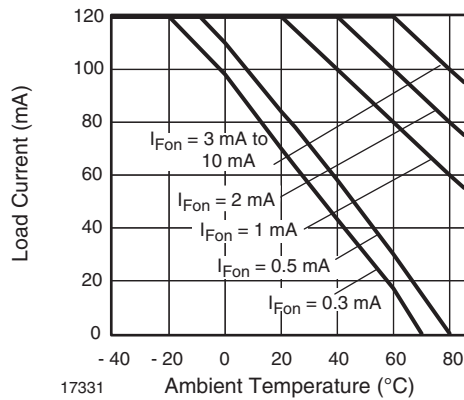

Fig. 1 - Recommended Operating Conditions

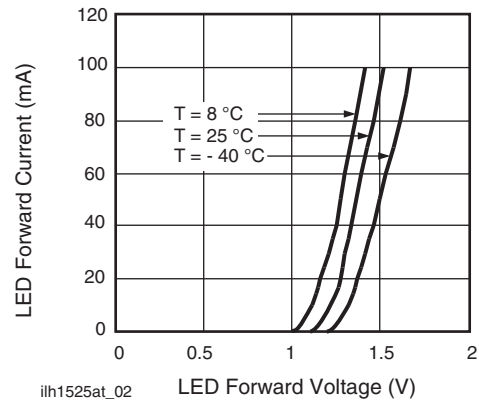

Fig. 3 - LED Forward Current vs. Forward Voltage

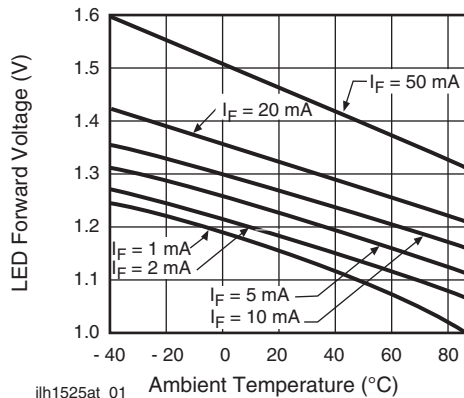

Fig. 2 - LED Voltage vs. Temperature

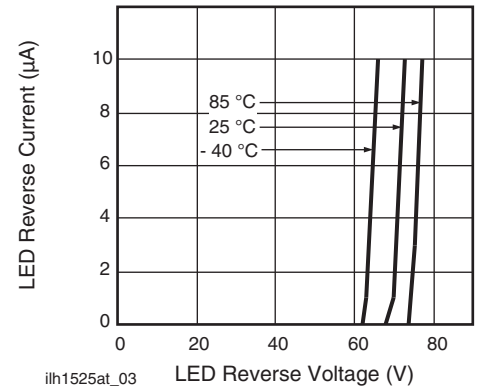

Fig. 4 - LED Reverse Current vs. LED Reverse Voltage

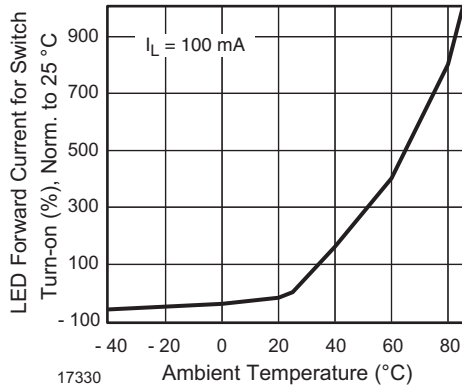
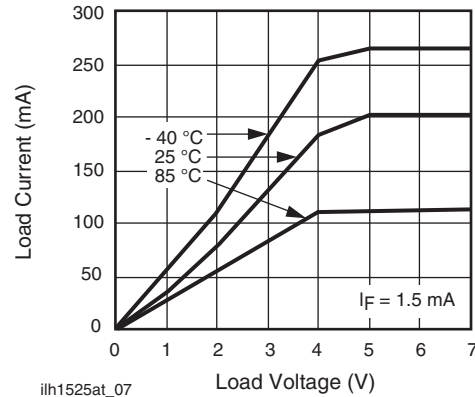
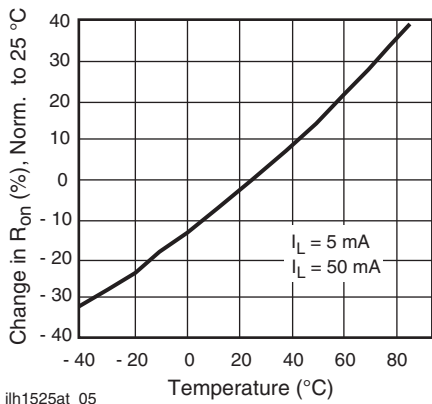

Fig. 5 - LED Current for Switch Turn-on vs. Temperature



ilh1525at\_07

Fig. 8 - Load Current vs. Load Voltage



ilh1525at\_05

Fig. 6 - On-Resistance vs. Temperature

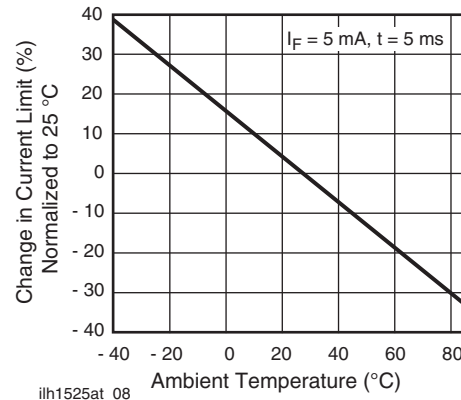

ilh1525at\_08

Fig. 9 - Current Limit vs. Temperature

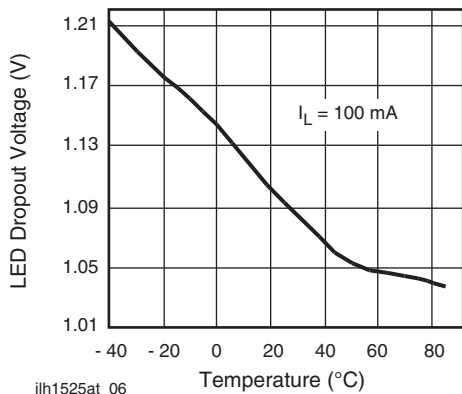

ilh1525at\_06

Fig. 7 - LED Dropout Voltage vs. Temperature

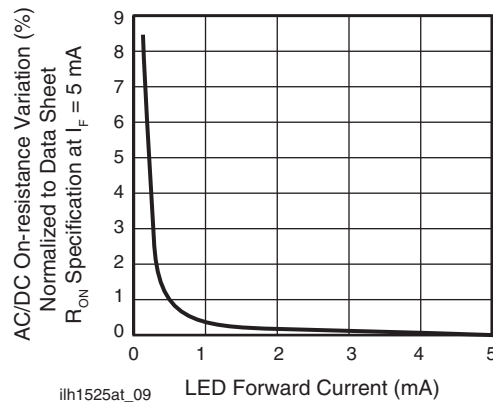

ilh1525at\_09

Fig. 10 - Variation in On-resistance vs. LED Current

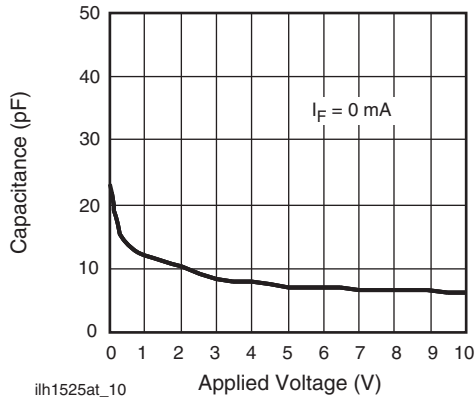

ilh1525at\_10

Fig. 11 - Switch Capacitance vs. Applied Voltage

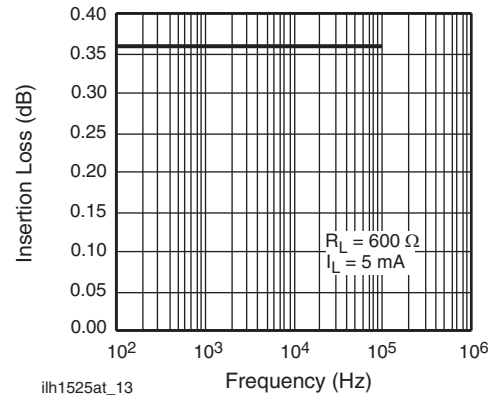

ilh1525at\_13

Fig. 14 - Insertion Loss vs. Frequency

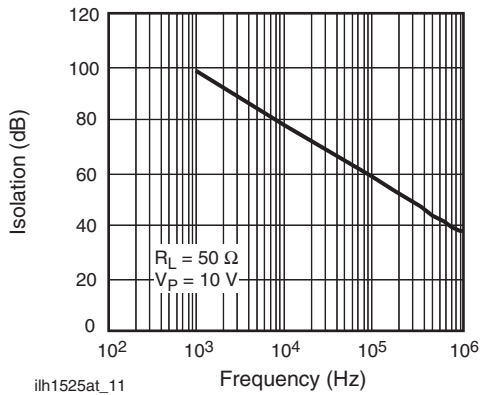

ilh1525at\_11

Fig. 12 - Output Isolation

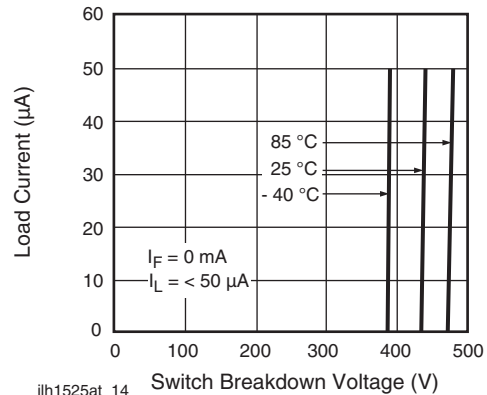

ilh1525at\_14

Fig. 15 - Switch Breakdown Voltage vs. Load Current

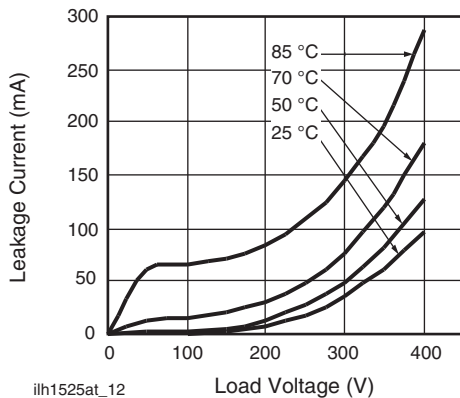

ilh1525at\_12

Fig. 13 - Leakage Current vs. Applied Voltage at Elevated Temperatures

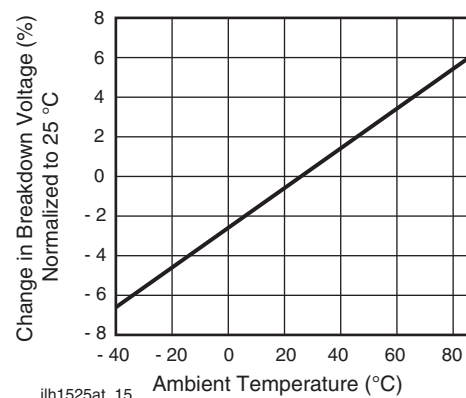

ilh1525at\_15

Fig. 16 - Switch Breakdown Voltage vs. Temperature

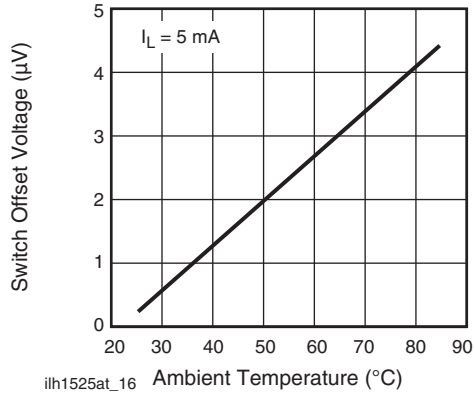

Fig. 17 - Switch Offset Voltage vs. Temperature

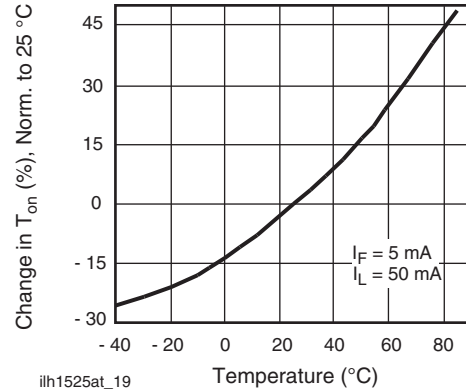

Fig. 20 - Turn-off Time vs. Temperature

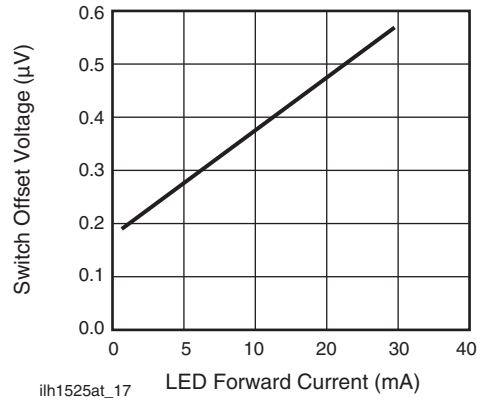

Fig. 18 - LED Offset Voltage vs. LED Current

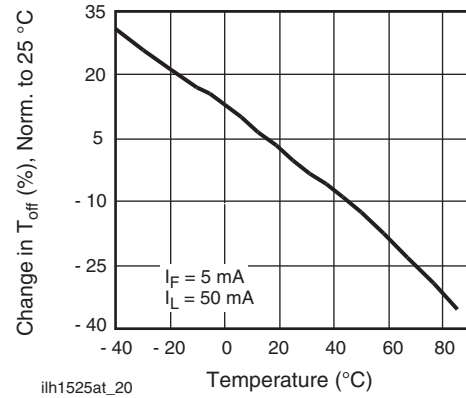

Fig. 21 - Turn-on Time vs. LED Temperature

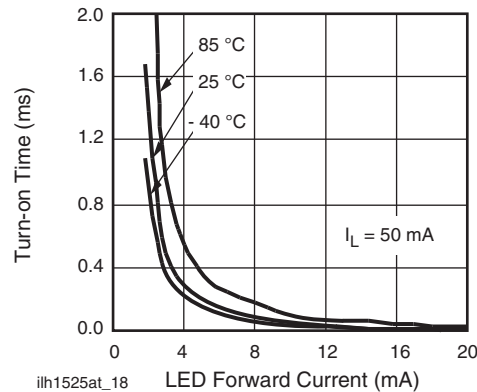

Fig. 19 - Turn-on Time vs. LED Current

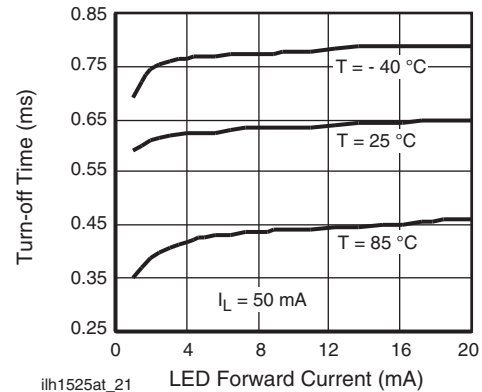

Fig. 22 - Turn-off Time vs. LED Current



## APPLICATIONS

### INPUT CONTROL

The LH1525 low turn-on current SSR has highly sensitive photodetection circuits that will detect even the most minute currents flowing through the LED. Leakage current must be considered when designing a circuit to turn on and off these relays.

Figure 23 shows a typical logic circuit for providing LED drive current.  $R_1$  is the input resistor that limits the amount of current flowing through the LED. For 5 V operation, a 2700  $\Omega$  resistor will limit the drive current to about 1.4 mA. Where high-speed actuation is desirable, use a lower value resistor for  $R_1$ . An additional RC peaking circuit is not required with the LH1525 relay.

$R_2$  is an optional pull-up resistor which pulls the logic level high output ( $V_{OH}$ ) up toward the  $V_S$  potential. The pull-up resistance is set at a high value to minimize the overall current drawn from the  $V_S$ . The primary purpose of this resistor is to keep the differential voltage across the LED below its turn-on threshold. LED dropout voltage is graphed vs. temperature in the typical performance characteristics section. When the logic gate is high, leakage current will flow through  $R_2$ .  $R_2$  will draw up to 8 mA before developing a

voltage potential which may possibly turn on the LED. Each application should be evaluated, over the full operating temperature range to make sure that leakage current through the input control LED is kept to a value less than the minimum LED forward current for switch turn-off specification.

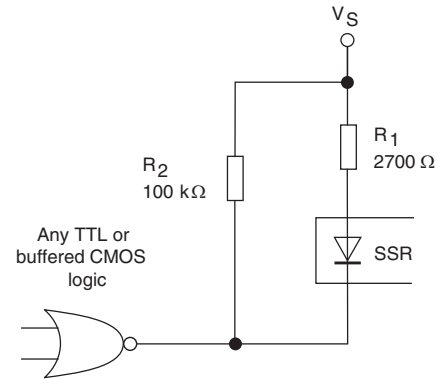

ilh1525at\_22

Fig. 23 - Input Control Circuit

### PACKAGE DIMENSIONS in millimeters

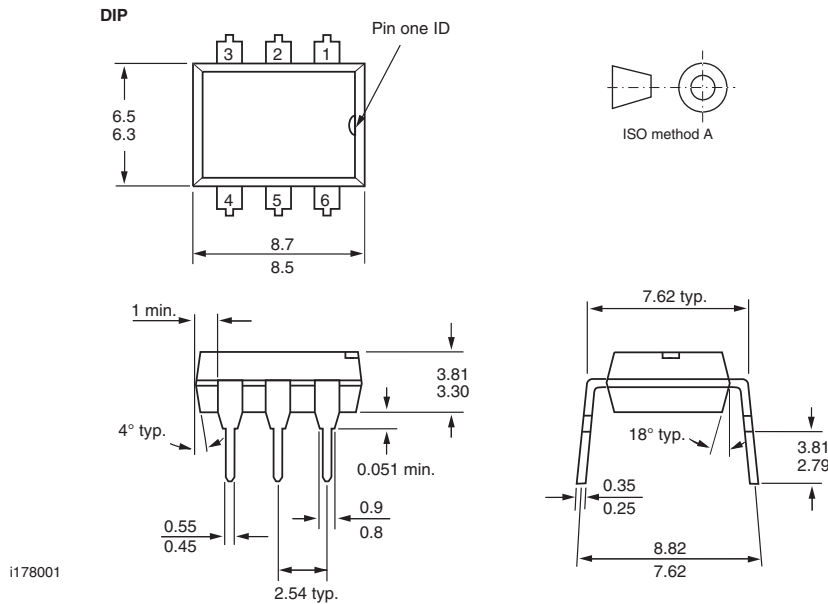

i178001

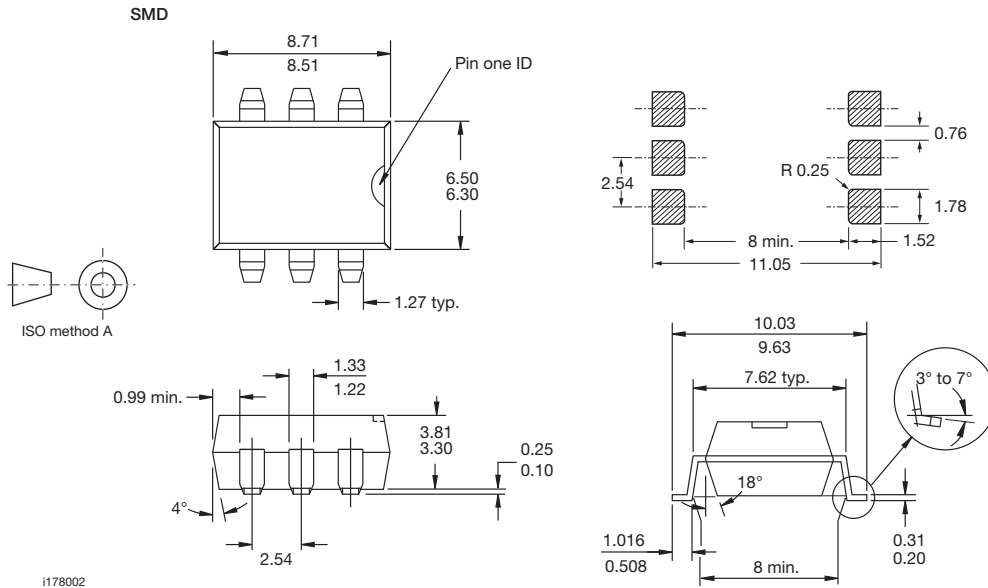

## PACKAGE MARKING

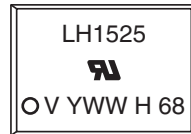

### Note

- Tape and reel suffix (TR) is not part of the package marking.





## Disclaimer

ALL PRODUCT, PRODUCT SPECIFICATIONS AND DATA ARE SUBJECT TO CHANGE WITHOUT NOTICE TO IMPROVE RELIABILITY, FUNCTION OR DESIGN OR OTHERWISE.

Vishay Intertechnology, Inc., its affiliates, agents, and employees, and all persons acting on its or their behalf (collectively, "Vishay"), disclaim any and all liability for any errors, inaccuracies or incompleteness contained in any datasheet or in any other disclosure relating to any product.

Vishay makes no warranty, representation or guarantee regarding the suitability of the products for any particular purpose or the continuing production of any product. To the maximum extent permitted by applicable law, Vishay disclaims (i) any and all liability arising out of the application or use of any product, (ii) any and all liability, including without limitation special, consequential or incidental damages, and (iii) any and all implied warranties, including warranties of fitness for particular purpose, non-infringement and merchantability.

Statements regarding the suitability of products for certain types of applications are based on Vishay's knowledge of typical requirements that are often placed on Vishay products in generic applications. Such statements are not binding statements about the suitability of products for a particular application. It is the customer's responsibility to validate that a particular product with the properties described in the product specification is suitable for use in a particular application. Parameters provided in datasheets and/or specifications may vary in different applications and performance may vary over time. All operating parameters, including typical parameters, must be validated for each customer application by the customer's technical experts. Product specifications do not expand or otherwise modify Vishay's terms and conditions of purchase, including but not limited to the warranty expressed therein.

Except as expressly indicated in writing, Vishay products are not designed for use in medical, life-saving, or life-sustaining applications or for any other application in which the failure of the Vishay product could result in personal injury or death. Customers using or selling Vishay products not expressly indicated for use in such applications do so at their own risk and agree to fully indemnify and hold Vishay and its distributors harmless from and against any and all claims, liabilities, expenses and damages arising or resulting in connection with such use or sale, including attorneys fees, even if such claim alleges that Vishay or its distributor was negligent regarding the design or manufacture of the part. Please contact authorized Vishay personnel to obtain written terms and conditions regarding products designed for such applications.

No license, express or implied, by estoppel or otherwise, to any intellectual property rights is granted by this document or by any conduct of Vishay. Product names and markings noted herein may be trademarks of their respective owners.