

Autonics Cylindrical Photoelectric Sensor BRQ SERIES (side sensing type) INSTRUCTION MANUAL



Thank you for choosing our Autonics product.
Please read the following safety considerations before use.

■ Safety Considerations

※ Please observe all safety considerations for safe and proper product operation to avoid hazards.
※ ⚠ symbol represents caution due to special circumstances in which hazards may occur.

- ⚠ Warning** Failure to follow these instructions may result in serious injury or death.
- ⚠ Caution** Failure to follow these instructions may result in personal injury or product damage.

⚠ Warning

- Fail-safe device must be installed when using the unit with machinery that may cause serious injury or substantial economic loss. (e.g. nuclear power control, medical equipment, ships, vehicles, railways, aircraft, combustion apparatus, safety equipment, crime/disaster prevention devices, etc.) Failure to follow this instruction may result in personal injury, economic loss or fire.
- Do not use the unit in the place where flammable/explosive/corrosive gas, high humidity, direct sunlight, radiant heat, vibration, impact, or salinity may be present. Failure to follow this instruction may result in explosion or fire.
- Do not disassemble or modify the unit. Failure to follow this instruction may result in fire.
- Do not connect, repair, or inspect the unit while connected to a power source. Failure to follow this instruction may result in fire.
- Check 'Connections' before wiring. Failure to follow this instruction may result in fire.

⚠ Caution

- Use the unit within the rated specifications. Failure to follow this instruction may result in fire or product damage.
- Use dry cloth to clean the unit, and do not use water or organic solvent. Failure to follow this instruction may result in fire.

■ Ordering Information

BRQ	P	S	20	M	T	D	T	A	C	P
Control output										
No mark NPN open collector output										
P PNP open collector output										
Connection										
No mark Cable type										
C Connector type										
Appearance										
A Standard										
Emitter/Receiver										
1 Emitter										
2 Receiver										
Output										
T Transistor output										
D DC power										
Sensing type										
T Through-beam type										
P Retroreflective type (built-in polarizing filter)										
D Diffuse reflective type										
Sensing distance unit										
No mark mm										
M m										
Form of sensing										
S Side sensing type										
Case material										
P Plastic										
Item										
BRQ Cylindrical photoelectric sensor										

※ This information is intended for product management of through-beam type. (no need to refer when selecting model)

■ Control Output Circuit Diagram

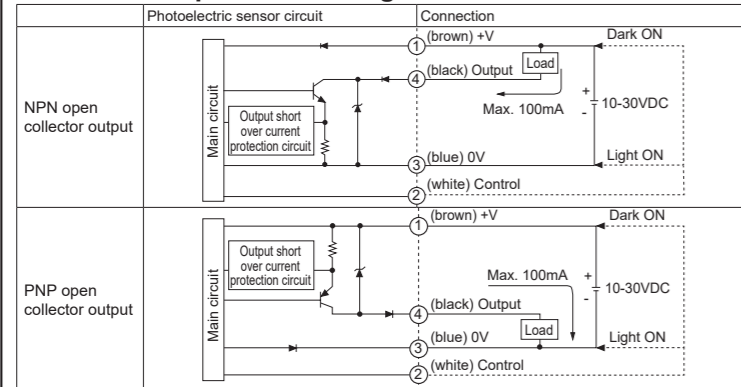

※ Before using this unit, select Light ON/Dark ON with control wire.
(Light ON: connect control wire to 0V/Dark ON: connect control wire to +V)
※ If short-circuit the control output terminal or supply current over the rated specification, normal control signal is not output due to the output short over current protection circuit.
※ The above specifications are subject to change and some models may be discontinued without notice.
※ Be sure to follow cautions written in the instruction manual and the technical descriptions (catalog, homepage).

■ Specifications

Model	BRQPS10M-TDTA(-C)	BRQPS20M-TDTA(-C)	BRQPS3M-PDTA(-C)	BRQPS100-DDTA(-C)	BRQPS400-DDTA(-C)	BRQPS700-DDTA(-C)
NPN open collector output	BRQPS10M-TDTA(-C)-P	BRQPS20M-TDTA(-C)-P	BRQPS3M-PDTA(-C)-P	BRQPS100-DDTA(-C)-P	BRQPS400-DDTA(-C)-P	BRQPS700-DDTA(-C)-P
PNP open collector output						
Sensing type	Through-beam type		Retroreflective type (built-in polarizing filter)	Diffuse reflective type		
Sensing distance	10m	20m	3m ^{※1}	100mm ^{※2}	400mm ^{※2}	700mm ^{※3}
Sensing target	Opaque materials of min. Ø7mm		Opaque materials of min. Ø75mm	Opaque, translucent materials		
Hysteresis	—					
Response time	Max. 1ms					
Power supply	10-30VDC [±] ±10% (ripple P-P: max. 10%)					
Current consumption	Emitter/Receiver : max. 20mA		Max. 30mA			
Light source	Red LED (660nm)					
Sensitivity adjustment	Sensitivity adjuster					
Operation mode	Selectable Light ON or Dark ON by control wire (white)					
Control output	NPN or PNP open collector output • Load voltage: max. 30VDC [±] • Load current: max. 100mA • Residual voltage: max. 2VDC [±] • Interference prevention function (except through-beam type)					
Protection circuit	Power/Output reverse polarity protection circuit, output short over current protection circuit, interference prevention function (except through-beam type)					
Indicator	Operation indicator: yellow LED, stability indicator: green LED (emitter power indicator of through-beam type: red LED)					
Connection	Cable type, connector type					
Insulation resistance	Max. 20MΩ (at 500VDC megger)					
Noise immunity	±240V the square wave noise (pulse width: 1μs) by the noise simulator					
Dielectric strength	1,000VAC 50/60Hz for 1 minute					
Vibration	1.5mm amplitude at frequency of 10 to 55Hz in each X, Y, Z direction for 2 hours					
Shock	500m/s ² (approx. 50G) in each X, Y, Z direction for 3 times					
Environment	Ambient illu.: Sunlight: max. 11,000lx, incandescent lamp: 3,000lx (receiver illumination)					
	Ambient temp.: -25 to 60°C, storage: -30 to 70°C					
	Ambient humi.: 35 to 85%RH, storage: 35 to 85%RH					
Protection structure	IP67 (IEC standard)					
Material	Case: polycarbonate, lens/lens cover: polymethyl methacrylate acrylic					
Cable ^{※4}	Ø4mm, 4-wire, 2m (emitter of through-beam type: Ø4mm, 2-wire, 2m) (AWG26, core diameter: 0.52mm, number of cores: 20, insulator out diameter: Ø1mm)					
Accessory	Individual	Reflector (MS-2S)				
	Common	M18 fixing nut: 4, adjustment screwdriver				
Approval	CE					
Weight	Cable type	Approx. 170g (approx. 120g)	Approx. 130g (approx. 70g)			
	Connector type	Approx. 120g (approx. 35g)	Approx. 120g (approx. 25g)			

※1: The sensing distance is specified with the MS-2S reflector. The distance between the sensor and the reflector should be set over 0.1m. When using reflective tapes, the reflectivity will vary by the size of the tape.
※2: Non-glossy white paper 100×100mm.
※3: Non-glossy white paper 200×200mm.
※4: M12 connector cable is sold separately.
※5: The weight includes packaging. The weight in parenthesis is for unit only.
※ The temperature and humidity mentioned in Environment indicates a non freezing or condensation.

■ Dimensions

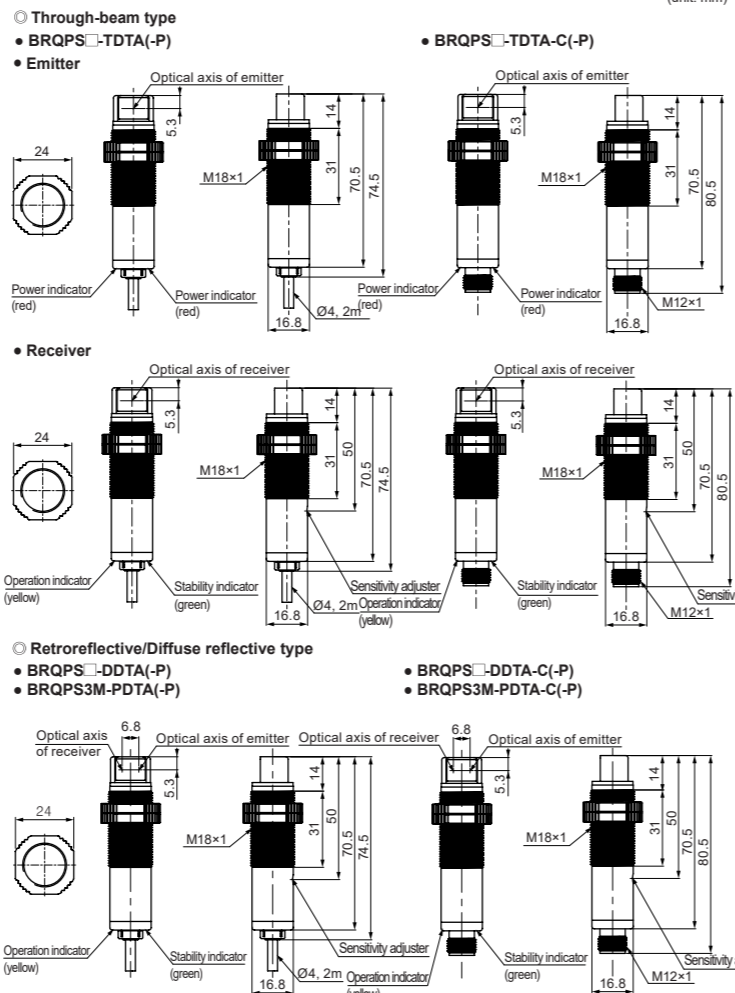

■ Connection

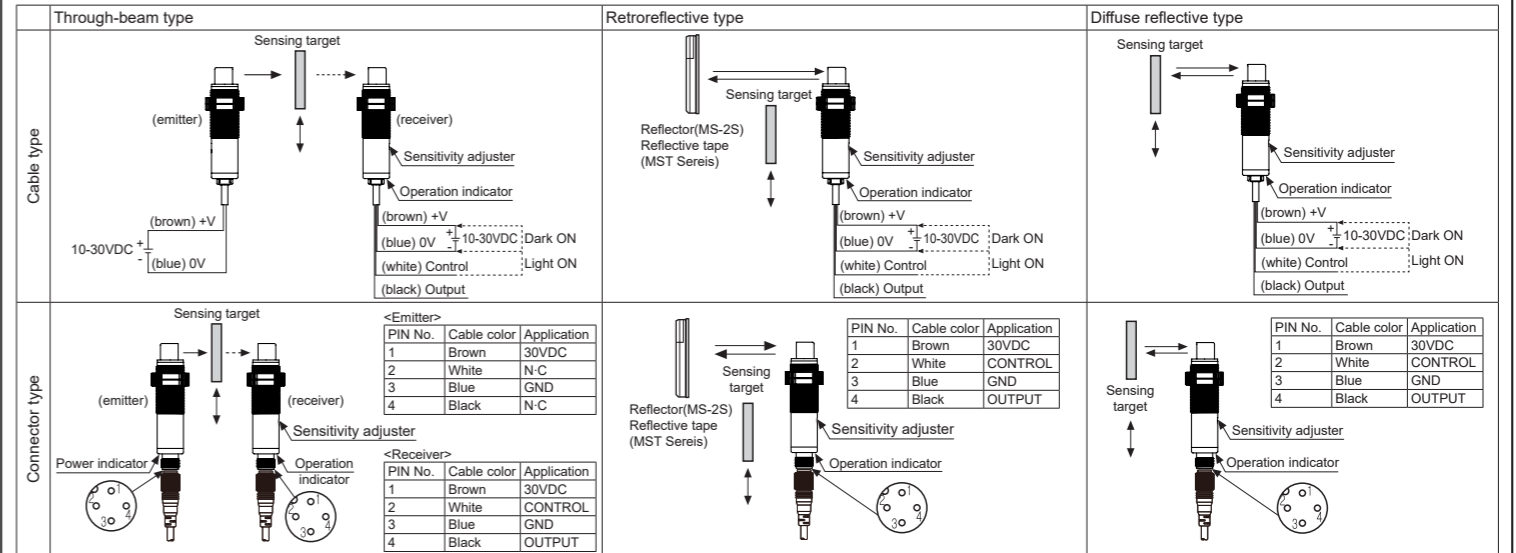

■ Installation and Adjustment

Install the sensor to the desired place and check the connections. Supply the power to the sensor and adjust the optical axis and the sensitivity as following.
When using the reflective type photoelectric sensors closely over three units, it may result in malfunction due to mutual interference.
When using the through-beam type photoelectric sensors closely over two units, it may result in malfunction due to mutual interference.
When installing the product, tighten the fixing nuts with a tightening torque of 0.39N·m.

○ Through-beam type

- Supply the power to the photoelectric sensor, after setting the emitter and the receiver facing each other.
- Set the receiver in center of position in the middle of the operation range of indicator adjusting the receiver or the emitter right and left, up and down.
- After adjustment, check the stability of operation putting the object at the optical axis.

※ If the sensing target is translucent or smaller than Ø7mm, it can be missed by sensor because light penetrate it.

○ Retroreflective type

- Supply the power to the photoelectric sensor, after setting the photoelectric sensor and the reflector (MS-2S) or reflective tape in face to face.
- Set the photoelectric sensor in the position which indicator turns on, as adjusting the reflector or the sensor right and left, up and down.
- Fix both units tightly after checking that the unit detects the target.

※ Sensitivity adjustment: Refer to the diffuse reflective type's.

○ Diffuse reflective type

- The sensitivity should be adjusted depending on a sensing target or mounting place.
- Set the target at a position to be detected by the beam, then turn the sensitivity adjuster until position ① where the operation indicator turns ON from min. position of the sensitivity adjuster.
- Take the target out of the sensing area, then turn the sensitivity adjuster until position ② where the operation indicator turns ON. If the indicator does not turn ON, max. position is ③.
- Set the sensitivity adjuster at the center of two switching position ①, ②.

※ Be aware of the fact that sensing distance can be different by size, surface and gloss of the target.

● M18 fixing nut

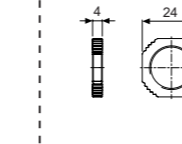

● Reflector (MS-2S)

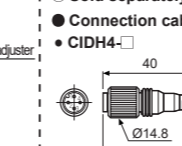

● Sold separately

● Connection cable

● CIDH4-□

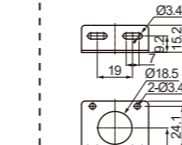

● CLDH4-□

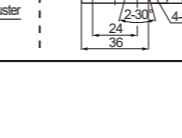

● Bracket(BK-BR-A)

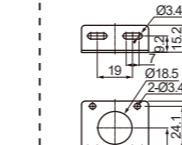

● Reflective tape

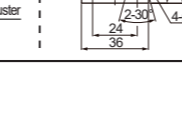

Model	A
MST-50-10	□50
MST-100-5	□100
MST-200-2	□200

■ Operation Timing Diagram

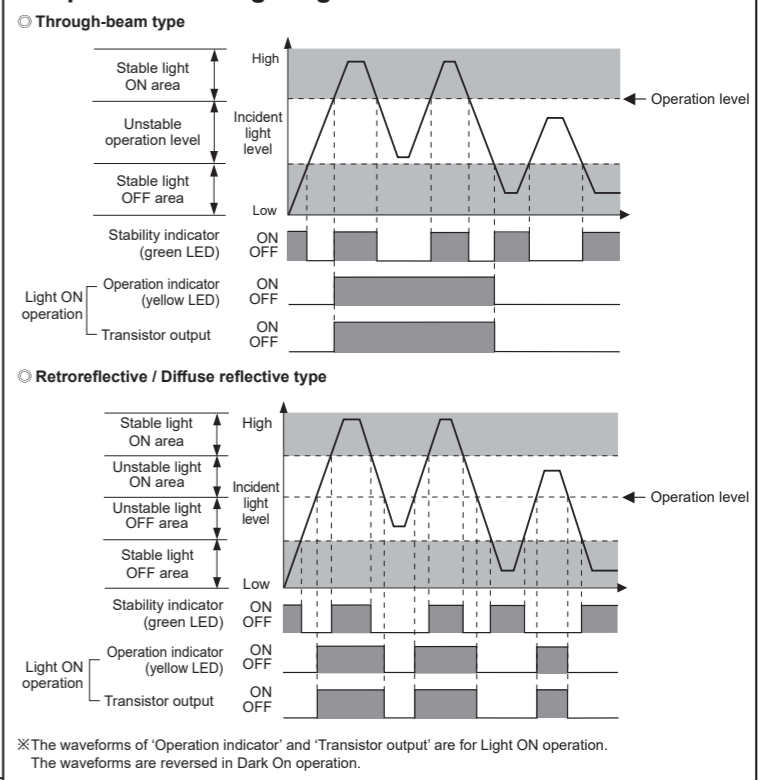

■ Cautions during Use

- Follow instructions in 'Cautions during Use'. Otherwise, It may cause unexpected accidents.
- When connecting a DC relay or other inductive load to the output, remove surge by using diodes or varistors.
- Use the product, 0.5 sec after supplying power.
When using separate power supply for the sensor and load, supply power to sensor first.
- Power supply should be insulated and limited voltage/current or Class 2, SELV power supply device.
- Wire as short as possible and keep away from high voltage lines or power lines, to prevent inductive noise.
- When using switching mode power supply to supply the power, ground F.G. terminal and connect a condenser between 0V and F.G. terminal to remove noise.
- When using sensor with the equipment which generates noise (switching regulator, inverter, servo motor, etc.), ground F.G. terminal of the equipment.
- This unit may be used in the following environments.
 - ① Indoors (in the environment condition rated in 'Specifications')
 - ② Altitude max. 2,000m
 - ③ Pollution degree 3
 - ④ Installation category II

■ Major Products

- Photoelectric Sensors
- Fiber Optic Sensors
- Door Side Sensors
- Area Sensors
- Proximity Sensors
- Pressure Sensors
- Rotary Encoders
- Connectors/Sockets
- Switching Mode Power Supplies
- Control Switches/Lamps/Buzzers
- I/O Terminal Blocks & Cables
- Stepper Motors/Drivers/Motion Controllers
- Graphic/Logic Panels
- Field Network Devices
- Laser Marking System (Fiber, CO₂, Nd: YAG)
- Laser Welding/Cutting System
- Temperature Controllers
- Temperature/Humidity Transducers
- SSRs/Power Controllers
- Counters
- Timers
- Panel Meters
- Tachometer/Pulse (Rate) Meters
- Display Units
- Sensor Controllers

Autonics Corporation
http://www.autonics.com

■ HEADQUARTERS:
18, Bansong-ro 513 beon-gil, Haeundae-gu, Busan, South Korea, 48002
TEL: 82-51-519-3232
E-mail: sales@autonics.com