

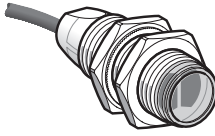









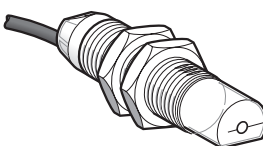

## Features

- **Wide product range**  
Shape: Standard type  
Side view type  
Connector: 2 m cable length type  
M12 plug-in connector type
- **Diffuse reflective type sensor with sensitivity adjuster is available.**
- **M18 thread size for convenient mounting**
- **Strong resistance IP67**
- **Convenient universal sensor mounting stand is available.**

## ORDER GUIDE

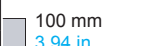
### 2 m cable length type

| Type      | Appearance  | Sensing range  | Model No. (Note 1)  |              | Output operation |          |
|-----------|---|--|---|--------------|------------------|----------|
|           |   |  | NPN output  | PNP output   |                  |          |
| Standard  |  |  15 m<br>49.21 ft   | CY-111A   | CY-111A-P    | Light-ON         |          |
|           |   |  | CY-111B   | CY-111B-P    | Dark-ON          |          |
|           |   |  4 m<br>13.12 ft    | CY-192A-Y   | CY-192A-P-Y  | Light-ON         |          |
|           |   |  | CY-192B-Y   | CY-192B-P-Y  | Dark-ON          |          |
|           |   |  2 m<br>6.56 ft     | CY-191A-Y   | CY-191A-P-Y  | Light-ON         |          |
|           |   |  | CY-191B-Y   | CY-191B-P-Y  | Dark-ON          |          |
|           |   |  100 mm<br>0.33 ft  | CY-121A   | CY-121A-P    | Light-ON         |          |
|           |   |  | CY-121B   | CY-121B-P    | Dark-ON          |          |
|           |   |  |  600 mm<br>1.97 ft | CY-122A      | CY-122A-P        | Light-ON |
|           |   |  |   | CY-122B      | CY-122B-P        | Dark-ON  |
| Side view |  |  15 m<br>49.21 ft   | CY-111VA  | CY-111VA-P   | Light-ON         |          |
|           |   |  | CY-111VB  | CY-111VB-P   | Dark-ON          |          |
|           |   |  4 m<br>13.12 ft    | CY-192VA-Y  | CY-192VA-P-Y | Light-ON         |          |
|           |   |  | CY-192VB-Y  | CY-192VB-P-Y | Dark-ON          |          |
|           |   |  2 m<br>6.56 ft     | CY-191VA-Y  | CY-191VA-P-Y | Light-ON         |          |
|           |   |  | CY-191VB-Y  | CY-191VB-P-Y | Dark-ON          |          |
|           |   |  100 mm<br>3.94 in  | CY-121VA  | CY-121VA-P   | Light-ON         |          |
|           |   |  | CY-121VB  | CY-121VB-P   | Dark-ON          |          |
|           |   |  600 mm<br>23.62 in | CY-122VA  | CY-122VA-P   | Light-ON         |          |
|           |   |  | CY-122VB  | CY-122VB-P   | Dark-ON          |          |

Notes: 1) The model No. with "E" shown on the label affixed to the thru-beam type sensor is the emitter, "D" shown on the label is the receiver.

(e.g.) Emitter of CY-111A: CY-111E, Receiver of CY-111A: CY-111AD

2) The reflector is sold separately.

3) The sensing range of the retroreflective type sensor is specified for the RF-420 reflector (optional).

### M12 plug-in connector type

M12 plug-in connector type is also available.

When ordering this type, "-Z" for the M12 plug-in connector type to the model No.

(e.g.) M12 plug-in connector type of CY-111A-P is "CY-111A-P-Z".

In case of the retroreflective type, M12 plug-in connector type of CY-19□-P-Y is "CY-19□-P-Z-Y".

• Standard type

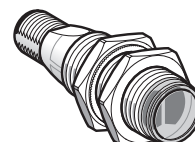

• Side view type

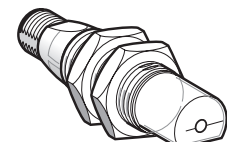

## ORDER GUIDE

### Mating cable (2 cables are required for the thru-beam type.)

| Type                           |          | Model No.         | Description                 |   |
|--------------------------------|----------|-------------------|-----------------------------|---|
| For M12 plug-in connector type | Straight | <b>CN-24C-C2</b>  | Length: 2 m <b>6.56 ft</b>  | Clamping ring :<br>ø14mm <b>0.55 in</b> |
|                                |          | <b>CN-24C-C5</b>  | Length: 5 m <b>16.40 ft</b> |   |
|                                | Elbow    | <b>CN-24CL-C2</b> | Length: 2 m <b>6.56 ft</b>  | Cable outer :<br>ø5.3mm <b>0.21 in</b>  |
|                                |          | <b>CN-24CL-C5</b> | Length: 5 m <b>16.40 ft</b> |   |

### Mating cable

#### • Straight type

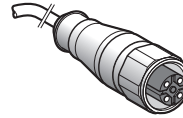

#### • Elbow type

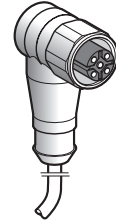

## OPTIONS

| Designation                     | Model No.       | Description  |
|---------------------------------|-----------------|--|
| Sensor mounting bracket         | <b>MS-CY1-1</b> | Material: Stainless steel  |
|                                 | <b>MS-CY1-2</b> | Material: Plastic, For beam axis alignment   |
| Universal sensor mounting stand | <b>MS-AJ3</b>   | It can adjust the height of the sensor and reflector <b>RF-420</b> . (The thru-beam type sensor needs two brackets.) |
| Reflector                       | <b>RF-420</b>   | 50 × 50 mm <b>1.97 × 1.97 in</b>   |
|                                 | <b>RF-410</b>   | 24 × 21 mm <b>0.94 × 0.83 in</b>   |
| Reflective tape                 | <b>RF-40RL5</b> | 22 mm × 5 m <b>0.87 × 196.85 in</b> , Thickness: 0.4 mm <b>0.02 in</b>   |

### Sensor mounting bracket

#### • MS-CY1-1



#### • MS-CY1-2

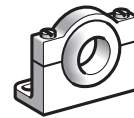

### Universal sensor mounting stand

#### • MS-AJ3

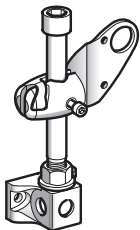

### Reflector

#### • RF-420

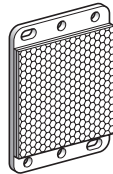

#### • RF-410

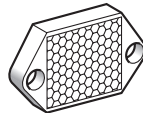

### Reflective tape

#### • RF-40RL5

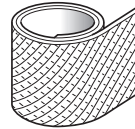

## WIRING DIAGRAMS

### Wiring diagram

#### Emitter of thru-beam type

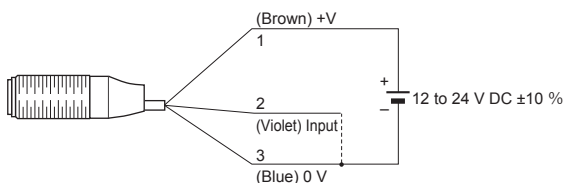

#### Receiver of thru-beam / Reflective type

##### NPN output type

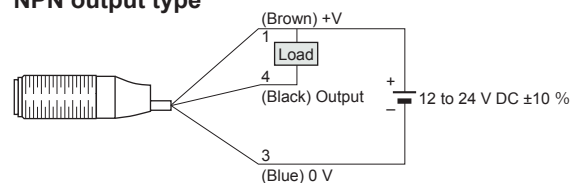

#### Receiver of thru-beam / Reflective type

##### PNP output type

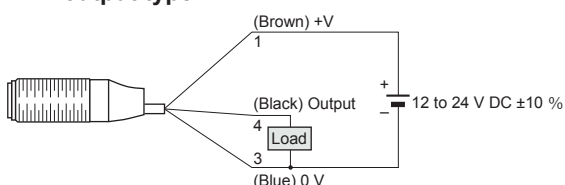

### Connector pin position

#### M12 connector

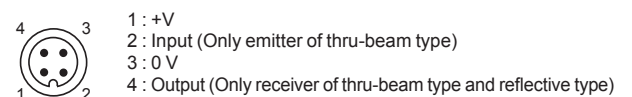

**SPECIFICATIONS**

| Item   | Model No.                  | Type     | Thru-beam  |                                 | Retroreflective  |              |   |              | Diffuse reflective                                 |              |                                 |           |
|--|----------------------------|----------|--|---------------------------------|--|--------------|---|--------------|--|--------------|---------------------------------|-----------|
|  |                            |          | Standard   | Side view                       | Standard   | Side view    | With polarizing filters   |              | Standard   | Side view    | With sensitivity adjuster       |           |
|  |                            |          |  |                                 |  |              | Standard  | Side view    |  |              | Standard                        | Side view |
|  |                            | Light-ON | CY-111A□   | CY-111VA□                       | CY-192A□   | CY-192VA□    | CY-191A□  | CY-191VA□    | CY-121A□   | CY-121VA□    | CY-122A□                        | CY-122VA□ |
|  |                            | Dark-ON  | CY-111B□   | CY-111VB□                       | CY-192B□   | CY-192VB□    | CY-191B□  | CY-191VB□    | CY-121B□   | CY-121VB□    | CY-122B□                        | CY-122VB□ |
| Sensing range                                  |                            |          | 15 m <b>49.21 ft</b>   |                                 | 4 m <b>13.12 ft</b> (Note 2)   |              | 2 m <b>6.56 ft</b> (Note 2)   |              | 100 mm <b>3.94 in</b> (Note 3)                     |              | 600 mm <b>23.62 in</b> (Note 3) |           |
| Sensing object                                 |                            |          | ø18 mm <b>ø0.71 in</b> or more opaque object (Setting distance between emitter and receiver: 15 m <b>49.21ft</b> )   |                                 | ø50 mm <b>ø1.97 in</b> or more opaque, translucent or transparent object (Note 2, 4) |              | ø50 mm <b>ø1.97 in</b> or more opaque, translucent, transparent or specular object (Note 2, 4)  |              | Opaque, translucent or transparent object (Note 4) |              |                                 |           |
| Hysteresis                                     |                            |          | 3 to 15 % of operation distance (Note 3)   |                                 |  |              |   |              |  |              |                                 |           |
| Supply voltage                                 |                            |          | 12 to 24 V DC ±10 % Ripple P-P 10 % or less  |                                 |  |              |   |              |  |              |                                 |           |
| Current consumption                            |                            |          | Emitter: 35 mA or less<br>Receiver: 35 mA or less  |                                 | 35 mA or less  |              |   |              |  |              |                                 |           |
| Output   |                            |          | <NPN output type><br>NPN open-collector transistor<br>• Maximum sink current: 100 mA<br>• Applied voltage: 24 V DC or less (between output and 0 V)<br>• Residual voltage: 1.5 V or less |                                 |  |              | <PNP output type><br>PNP open-collector transistor<br>• Maximum source current: 100 mA<br>• Applied voltage: 24 V DC or less (between output and +V)<br>• Residual voltage: 1.5 V or less |              |  |              |                                 |           |
| Utilization category                           |                            |          | DC-12 or DC-13   |                                 |  |              |   |              |  |              |                                 |           |
| Short-circuit protection                       |                            |          | Incorporated   |                                 |  |              |   |              |  |              |                                 |           |
| Response time                                  |                            |          | 1 ms or less   |                                 |  |              |   |              |  |              |                                 |           |
| Test input (emission halt) function            |                            |          | Incorporated   |                                 |  |              |   |              |  |              |                                 |           |
| Operation indicator                            |                            |          | Yellow LED (lights up when the output is ON) (incorporated on the receiver for thru-beam type)   |                                 |  |              |   |              |  |              |                                 |           |
| Power indicator                                |                            |          | Green LED (lights up when the power is ON) (incorporated on the emitter)   |                                 |  |              |   |              |  |              |                                 |           |
| Environmental resistance                       | Pollution degree           |          | 3 (Industrial environment)   |                                 |  |              |   |              |  |              |                                 |           |
|  | Protection                 |          | IP67 (IEC)   |                                 |  |              |   |              |  |              |                                 |           |
|  | Ambient temperature        |          | -25 to +55 °C <b>-13 to +131 °F</b> (No dew condensation or icing allowed), Storage: -40 to +70 °C <b>-22 to +158 °F</b>   |                                 |  |              |   |              |  |              |                                 |           |
|  | Ambient humidity           |          | 50 % RH (at +70 °C <b>+158 °F</b> )  |                                 |  |              |   |              |  |              |                                 |           |
|  | Ambient illuminance        |          | Incandescent light: 5,000 lx at the light-receiving face   |                                 |  |              |   |              |  |              |                                 |           |
|  | EMC                        |          | EN 60947-5-2   |                                 |  |              |   |              |  |              |                                 |           |
|  | Voltage withstandability   |          | 500 V AC for one min. between all supply terminals connected together and enclosure  |                                 |  |              |   |              |  |              |                                 |           |
|  | Vibration resistance       |          | 10 to 55 Hz frequency, 0.5 mm <b>0.02 in</b> amplitude in X, Y and Z directions for 1.5 hours each   |                                 |  |              |   |              |  |              |                                 |           |
|  | Shock resistance           |          | 294 m/s <sup>2</sup> acceleration (30 G approx.) in X, Y and Z directions for three times each   |                                 |  |              |   |              |  |              |                                 |           |
| Emitting element                               |                            |          | Infrared LED (modulated)   |                                 |  |              | Red LED (modulated)   |              | Infrared LED (modulated)                           |              |                                 |           |
| Peak emission wavelength                       |                            |          | 890 nm <b>0.04 mil</b>   |                                 | 875 nm <b>0.03 mil</b>   |              | 665 nm <b>0.03 mil</b>  |              | 875 nm <b>0.03 mil</b>                             |              |                                 |           |
| Material                                       |                            |          | Enclosure: PBT, Lens: PMMA   |                                 |  |              |   |              |  |              |                                 |           |
| Cable (except for M12 plug-in connection type) |                            |          | 0.44 mm <sup>2</sup> 3-core cabtyre cable, 2 m <b>6.56 ft</b> long   |                                 |  |              |   |              |  |              |                                 |           |
| Cable extension                                |                            |          | Extension up to total 10 m <b>32.81 ft</b> is possible with 0.34 mm <sup>2</sup> , or more, cable (thru-beam type: both emitter and receiver).   |                                 |  |              |   |              |  |              |                                 |           |
| Net weight (Note 5)                            | 2 m cable length type      |          | Emitter/ Receiver: 65 g approx.  | Emitter/ Receiver: 70 g approx. | 65 g approx.   | 70 g approx. | 65 g approx.  | 70 g approx. | 65 g approx.                                       | 70 g approx. | 75 g approx.                    |           |
|  | M12 plug-in connector type |          | Emitter/ Receiver: 15 g approx.  | Emitter/ Receiver: 20 g approx. | 15 g approx.   | 20 g approx. | 15 g approx.  | 20 g approx. | 15 g approx.                                       | 20 g approx. | 25 g approx.                    |           |
| Accessories                                    |                            |          | Nut: 4 pcs.  |                                 |  | Nut: 2 pcs.  |   |              |  |              |                                 |           |

Notes: 1) Where measurement conditions have not been specified precisely, the conditions used were an ambient temperature of +23 °C **+73.4 °F**.  
 2) The sensing range and the sensing object of the retroreflective type sensor are specified for the **RF-420** reflector (optional).  
 3) The sensing range and the hysteresis of the diffuse reflective type sensor are specified for white non-glossy paper (200 × 200 mm **7.87 × 7.87 in**) as the object.  
 4) Make sure to confirm detection with an actual sensor before use for detection of the transparent object and the translucent object.  
 5) The weight includes the weight of nuts.

## DETECTION CURVES

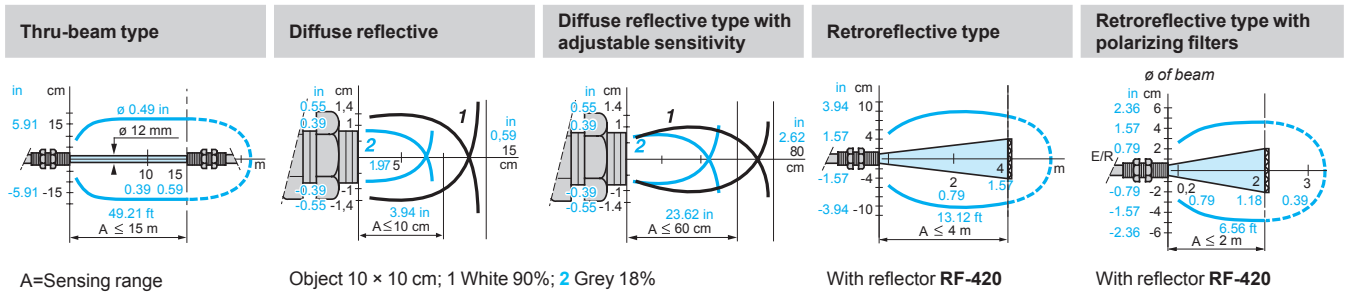

## PRECAUTIONS FOR PROPER USE



- Never use this product as a sensing device for personnel protection.
- In case of using sensing devices for personnel protection, use products which meet laws and standards, such as OSHA, ANSI or IEC etc., for personnel protection applicable in each region or country.

### Mounting

- The tightening torque should be 3 N·m or less.
- Use a cable with connector **CN-24C(L)-C□** (optional) for M12 connector type.  
Tightening torque for connector part is 2 N·m or less.

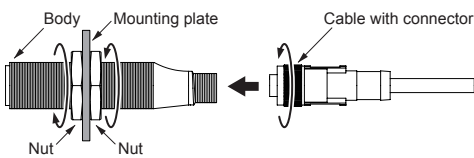

### Mounting drawing with sensor or reflector RF-420

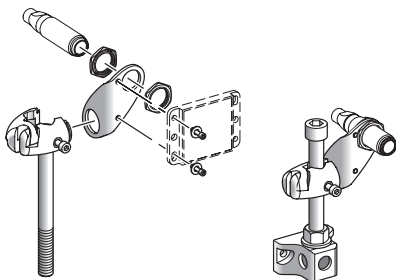

### Wiring

- Make sure that the power supply is off while wiring.
- Verify that the supply voltage variation is within the rating.
- If power is supplied from a commercial switching regulator, ensure that the frame ground (F.G.) terminal of the power supply is connected to an actual ground.
- Ensure that an isolation transformer is utilized for the DC power supply. If an autotransformer is utilized, the main body or power supply may be damaged.
- If the used power supply generates a surge, connect a surge absorber to the power supply to absorb the surge.
- Do not use during the initial transient time (0.5 sec) after the power supply is switched on.
- In case noise generating equipment (switching regulator, inverter motor, etc.) is used in the vicinity of this product, connect the frame ground (F.G.) terminal of the equipment to an actual ground.
- Do not run the wires together with high-voltage lines or power lines or put them in the same raceway. This can cause malfunction due to induction.
- Damage or burnout may result in case of short circuit of load or miswiring.
- Make a cable length as short as possible to lessen noise pickup.

### Others

- Our products have been developed / produced for industrial use only.
- Take care that the sensor is not directly exposed to fluorescent lamp from a rapid-starter lamp or a high frequency lighting device, as it may affect the sensing performance.
- Avoid using a product where there is excessive vapor, dust or corrosive gas, or in a place where it could be exposed directly to water or chemicals.
- Take care that the sensor does not come in direct contact with water, oil, grease or organic solvents, such as, thinner, etc.
- Do not use in an environment containing inflammable or explosive gases.
- Never disassemble or modify the product.

**DIMENSIONS (Unit: mm in)**

**CY-1□** Sensor

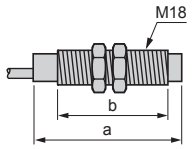

|  | 2 m cable length type (mm in) |                | M12 plug-in connector type (mm in) |                |
|--|-------------------------------|----------------|------------------------------------|----------------|
|  | a                             | b              | a                                  | b              |
| Standard type <b>CY-111□/121□/192□</b>           | 46 <b>1.81</b>                | 28 <b>1.10</b> | 60 <b>2.36</b>                     | 28 <b>1.10</b> |
| Standard type <b>CY-191□</b>                     | 48 <b>1.89</b>                | 28 <b>1.10</b> | 62 <b>2.44</b>                     | 28 <b>1.10</b> |
| Side view type <b>CY-111V□/121V□/191V□/192V□</b> | 62 <b>2.44</b>                | 28 <b>1.10</b> | 76 <b>2.99</b>                     | 28 <b>1.10</b> |
| Standard type <b>CY-122□</b>                     | 62 <b>2.44</b>                | 44 <b>1.73</b> | 76 <b>2.99</b>                     | 44 <b>1.73</b> |
| Side view type <b>CY-122V□</b>                   | 78 <b>3.07</b>                | 44 <b>1.73</b> | 92 <b>3.62</b>                     | 44 <b>1.73</b> |

**CN-24C-C2 CN-24C-C5** Mating cable

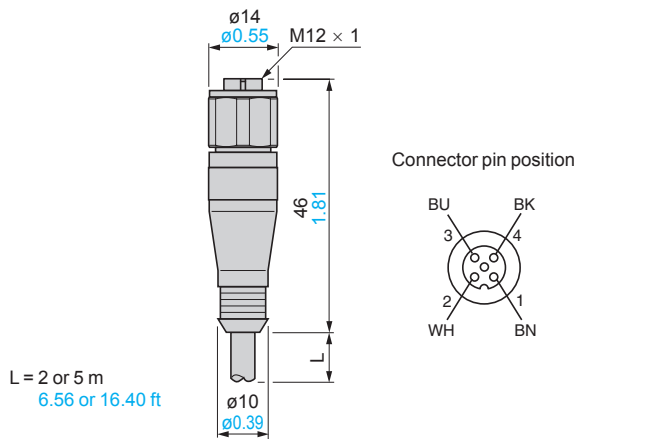

L = 2 or 5 m  
6.56 or 16.40 ft

**CN-24CL-C2 CN-24CL-C5** Mating cable

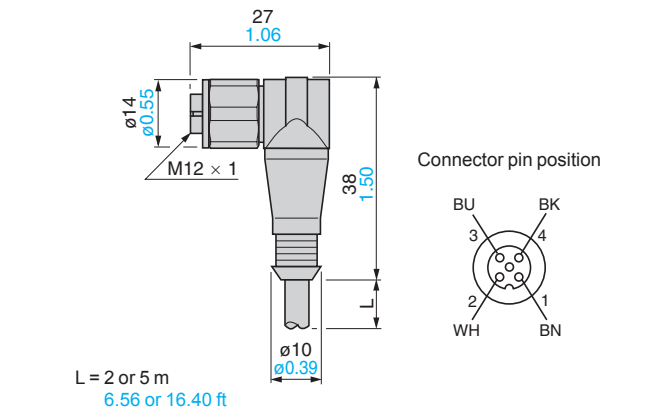

L = 2 or 5 m  
6.56 or 16.40 ft

**MS-CY1-1** Sensing mounting bracket

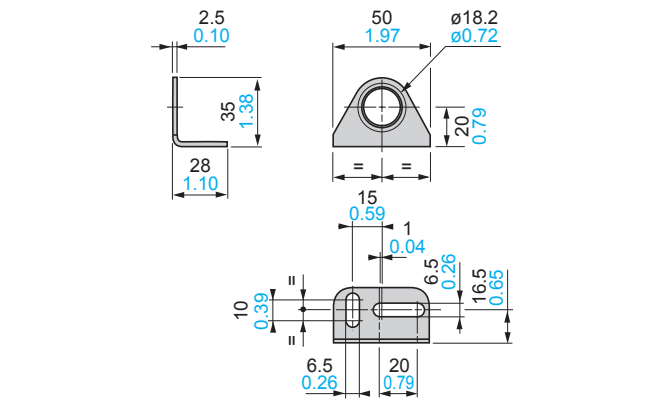

**MS-CY1-2** Sensing mounting bracket

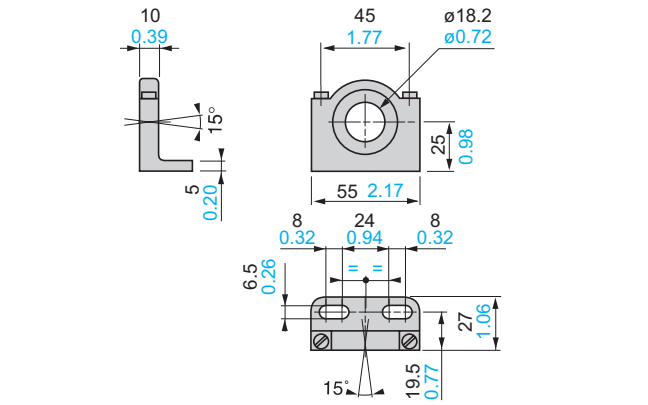

**MS-AJ3** Universal sensor mounting stand

