



ANLY PHOTO SENSOR

PHOTO SENSOR



TYPE SELECTION :

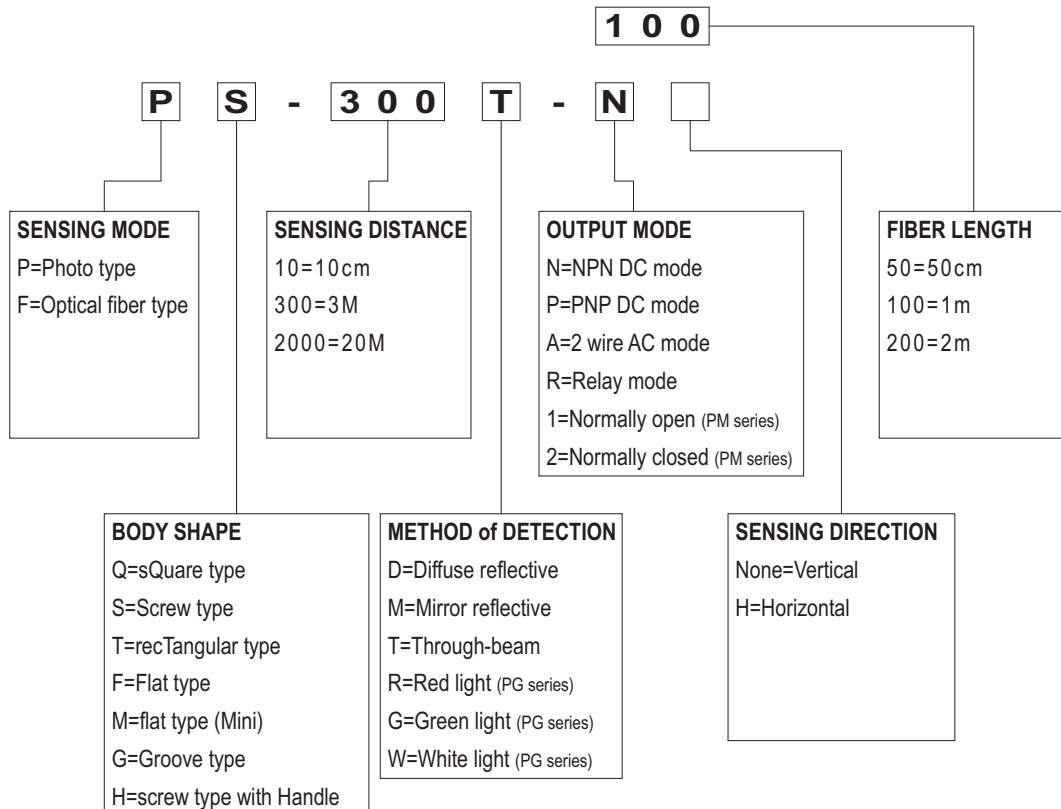

GENERAL DATA :

<p>PS-40D series</p>  <p>DC 10 ~ 30V Sensing distance: 40cm Switching frequency: 80Hz</p>	<p>PS-300M-H series</p>  <p>DC 10 ~ 30V Sensing distance: 3m Switching frequency: 60Hz</p>	<p>PS-2000T-H series</p>  <p>DC 10 ~ 30V Sensing distance: 20m Switching frequency: 60Hz</p>	<p>PS-10D series</p>  <p>DC 10 ~ 30V Sensing distance: 10cm Switching frequency: 80Hz</p>	<p>PS-30D series</p>  <p>DC 10 ~ 30V Sensing distance: 30cm Switching frequency: 80Hz</p>
<p>PS-300M series</p>  <p>DC 10 ~ 30V Sensing distance: 3m Switching frequency: 60Hz</p>	<p>PS-2000T series</p>  <p>DC 10 ~ 30V Sensing distance: 20m Switching frequency: 60Hz</p>	<p>PF-100D-R series</p>  <p>AC/DC 24 ~ 240V Sensing distance: 1m Switching frequency: 30Hz</p>	<p>PF-200D-R series</p>  <p>AC/DC 24 ~ 240V Sensing distance: 2m Switching frequency: 30Hz</p>	<p>PF-300M-R series</p>  <p>AC/DC 24 ~ 240V Sensing distance: 3m Switching frequency: 30Hz</p>
<p>PF-500M-R series</p>  <p>AC/DC 24 ~ 240V Sensing distance: 5m Switching frequency: 30Hz</p>	<p>PF-700M-R series</p>  <p>AC/DC 24 ~ 240V Sensing distance: 7m Switching frequency: 30Hz</p>	<p>PF-1000T-R series</p>  <p>AC/DC 24 ~ 240V Sensing distance: 10m Switching frequency: 30Hz</p>	<p>PF-2000T-R series</p>  <p>AC/DC 24 ~ 240V Sensing distance: 20m Switching frequency: 30Hz</p>	<p>PT-15D series</p>  <p>DC 10 ~ 30V Sensing distance: 15cm Switching frequency: 100Hz</p>
<p>PT-30D series</p>  <p>DC 10 ~ 30V Sensing distance: 30cm Switching frequency: 100Hz</p>	<p>PT-200M series</p>  <p>DC 10 ~ 30V Sensing distance: 2m Switching frequency: 80Hz</p>	<p>PT-200T series</p>  <p>DC 10 ~ 30V Sensing distance: 2m Switching frequency: 80Hz</p>	<p>FS-05T series</p>  <p>Fiber (φ1.0) Conjunction with AU-F01/02 Sensing distance: 5cm</p>	<p>FS-15T series</p>  <p>Fiber (φ2.2) Conjunction with AU-F01/02 Sensing distance: 15cm</p>
<p>FH-05T series</p>  <p>Fiber (φ1.0) Conjunction with AU-F01/02 Sensing distance: 5cm</p>	<p>FH-15T series</p>  <p>Fiber (φ2.2) Conjunction with AU-F01/02 Sensing distance: 15cm</p>	<p>FS-01D series</p>  <p>Fiber (φ1.0 x 2) Conjunction with AU-F01/02 Sensing distance: 1.2cm</p>	<p>FS-04D series</p>  <p>Fiber (φ2.2 x 2) Conjunction with AU-F01/02 Sensing distance: 4cm</p>	<p>FH-01D series</p>  <p>Fiber (φ1.0 x 2) Conjunction with AU-F01/02 Sensing distance: 1.2cm</p>
<p>FH-04D series</p>  <p>Fiber (φ2.2 x 2) Conjunction with AU-F01/02 Sensing distance: 4cm</p>	<p>AU-F01</p>  <p>DC 12 ~ 24V Switching frequency: 1kHz</p>	<p>AU-F02</p>  <p>DC 10 ~ 30V Switching frequency: 1kHz</p>	<p>PM-10D series</p>  <p>DC 10 ~ 30V Sensing distance: 10cm Switching frequency: 100Hz</p>	<p>PM-40D series</p>  <p>DC 10 ~ 30V Sensing distance: 40cm Switching frequency: 100Hz</p>

<p>PM-200M series</p>  <p>DC 10 ~ 30V Sensing distance: 2m Switching frequency: 80Hz</p>	<p>PM-200T series</p>  <p>DC 10 ~ 30V Sensing distance: 2m Switching frequency: 80Hz</p>	<p>PQ-10D-H series</p>  <p>DC 10 ~ 30V Sensing distance: 10cm Switching frequency: 80Hz</p>	<p>PQ-100M-H series</p>  <p>DC 10 ~ 30V Sensing distance: 1m Switching frequency: 60Hz</p>	<p>PQ-100T-H series</p>  <p>DC 10 ~ 30V Sensing distance: 1m Switching frequency: 60Hz</p>
<p>PG-06 series</p>  <p>DC 10 ~ 30V Sensing distance: 6mm Switching frequency: 60Hz</p>				

CONNECTION :

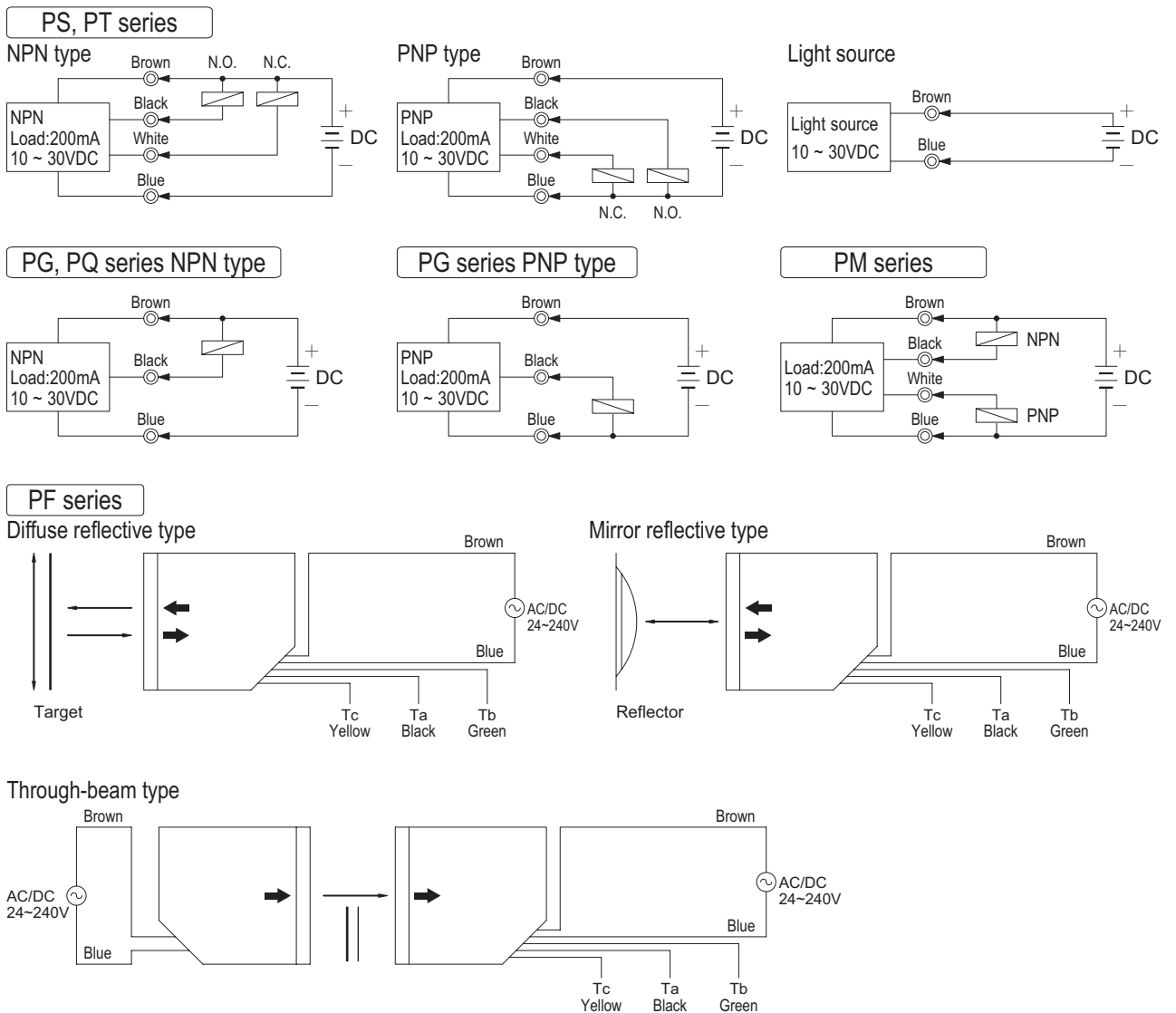

DIMENSIONS : (mm)

PS series

Horizontal type

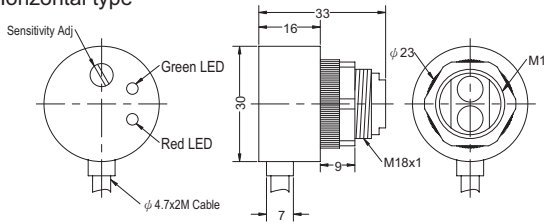

Vertical type

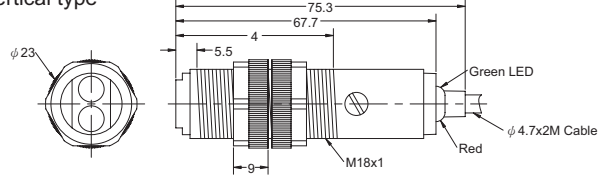

PT series

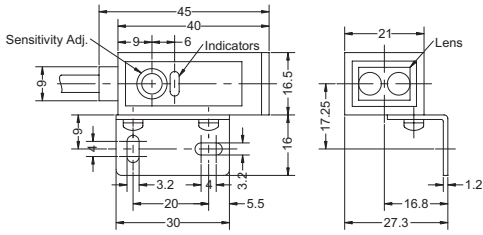

Reflector

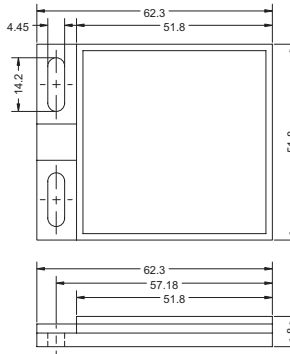

AU-F01

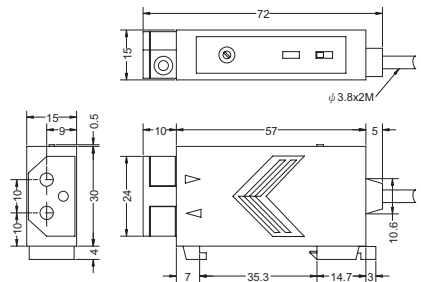

PF series

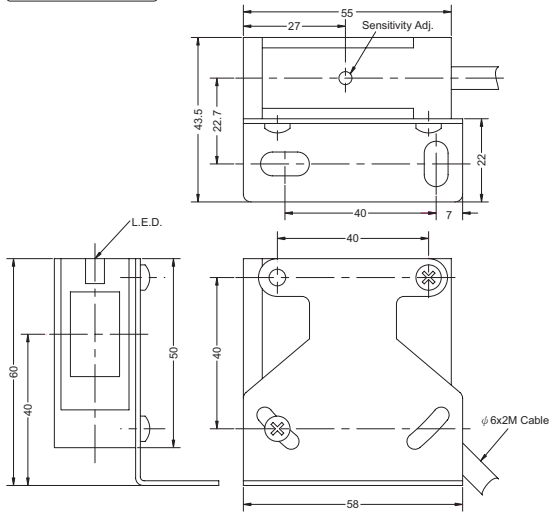

	A	B	C	D	E	F	G
FS-05T	φ 2.5	17	500	φ 1.0	M3 x 0.5	--	--
FS-15T	φ 3.2	17	500	φ 2.2	M4 x 0.7	--	--
FS-01D	φ 2.5	17	500	φ 1.0 x 2	M4 x 0.5	--	--
FS-04D	φ 5.2	17	500	φ 2.2 x 2	M6 x 0.75	--	--
FH-05T	φ 2.5	17	500	φ 1.0	M4 x 0.5	82	φ 1.7
FH-15T	φ 3.2	17	500	φ 2.2	M4 x 0.7	40	φ 1.7
FH-01D	φ 2.5	17	500	φ 1.0 x 2	M4 x 0.5	85	φ 1.7
FH-04D	φ 5.2	17	500	φ 2.2 x 2	M6 x 0.75	85	φ 2.5

PG series

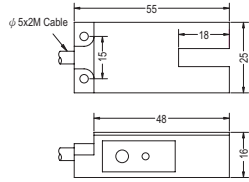

PQ series

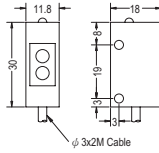

FS series

Through-beam type

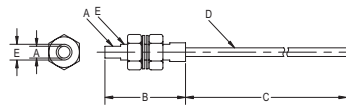

Diffuse reflective type

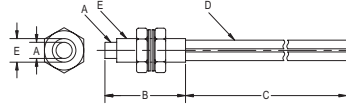

FH series

Through-beam type

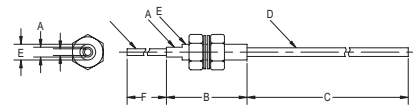

Diffuse reflective type

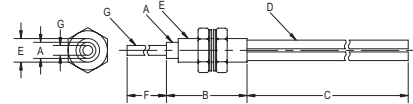

PM series

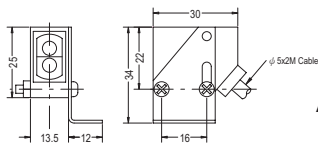

ANLY ELECTRONICS CO., LTD.

<http://www.anly.com.tw>

TAIWAN MAIN OFFICE : ANLY ELECTRONICS CO., LTD.

No.19, Lane 202, Fushou St., Shinjuang City, Taipei, Taiwan 242
TEL: +886-2-2996-3202 FAX: +886-2-2996-2017

MALAYSIA BRANCH : JUSTY ELECTRONICS (M) SDN, BHD.

No.1, Jalan 6/89B, Kawasan Perindustrian Trisegi, Batu 3 1/2 Off Jalan Sungei Besi, 57100 Kuala Lumpur, Malaysia
TEL: +60-3-7983-5758 FAX: +60-3-7981-5052

HONG KONG BRANCH : ANLY ELECTRONICS (HK) LTD.

Flat K, 13/F, Edward Mansion, 141 Prince Edward Road W., Kowloon, Hong Kong
TEL: +852-2397-2505 FAX: +852-2397-6080

CHINA SALES OFFICE : ANLY TECHNOLOGY (WUXI) CO., LTD.

Room 3D, Zhaofeng Building, No.9, Alley 396, Changning Rd., Changning District, Shanghai, China 200042
TEL: +86-21-6213-9371 FAX: +86-21-6212-3483