

Circuit breaker/Switch-disconnector  
 Disjoncteur/Interrupteur-sectionneur  
 Interruptor automático/Interruptor seccionador  
 断路器/隔离开关  
 Leistungsschalter/Lasttrennschalter  
 Interruttore automatico/interruttore-sezionatore  
 Disjuntor/Interruptor-seccionador  
 Выключатель/Разъединитель

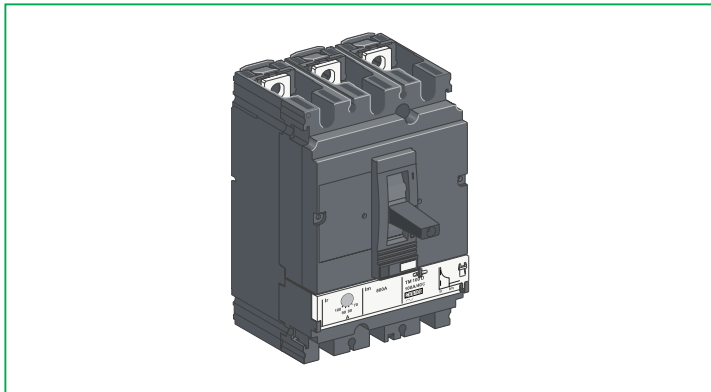

S1A19928-07

<p><b>PLEASE NOTE</b>                  Electrical equipment should be installed, operated, serviced, and maintained only by qualified personnel. No responsibility is assumed by Schneider Electric for any consequences arising out of the use of this material.</p>	<p><b>BITTE BEACHTEN</b>                  Elektrische Geräte dürfen nur von Fachpersonal installiert, betrieben, bedient und gewartet werden. Schneider Electric haftet nicht für Schäden, die durch die Verwendung dieses Materials entstehen.</p>
<p><b>REMARQUE IMPORTANTE</b>                  L'installation, l'utilisation, la réparation et la maintenance des équipements électriques doivent être assurés uniquement par du personnel qualifié. Schneider Electric décline toute responsabilité quant aux conséquences de l'utilisation de ce matériel.</p>	<p><b>NOTA</b>                  Manutenzione, riparazione, installazione e uso delle apparecchiature elettriche si devono affidare solo a personale qualificato. Schneider Electric non si assume alcuna responsabilità per qualsiasi conseguenza derivante dall'uso di questo materiale.</p>
<p><b>TENGA EN CUENTA</b>                  La instalación, manejo, puesta en servicio y mantenimiento de equipos eléctricos deberán ser realizados sólo por personal cualificado. Schneider Electric no se hace responsable de ninguna de las consecuencias del uso de este material.</p>	<p><b>NOTA</b>                  A instalação, utilização e manutenção do equipamento eléctrico devem ser efectuadas exclusivamente por pessoal qualificado. A Schneider Electric não assume qualquer responsabilidade pelas consequências resultantes da utilização deste material.</p>
<p>请注意                  电气设备的安装、操作、维修和维护工作仅限于合格人员执行。Schneider Electric不承担由于使用本资料所引起的任何后果。</p>	<p><b>ОБРАТИТЕ ВНИМАНИЕ</b>                  Установка, эксплуатация, ремонт и обслуживание электрического оборудования может выполняться только квалифицированными электриками. Компания Schneider Electric не несет никакой ответственности за любые возможные последствия использования данной документации.</p>

**⚠️ DANGER / DANGER / PELIGRO / 危險 / GEFAHR / PERICOLO / PERIGO / ОПАСНОСТЬ**

<p><b>HAZARD OF ELECTRIC SHOCK, EXPLOSION OR ARC FLASH</b>                  ■ Apply appropriate personal protective equipment (PPE) and follow safe electrical work practices. See NFPA 70E, CSA Z462 or local equivalent.                  ■ This equipment must only be installed and serviced by qualified electrical personnel.                  ■ Turn off all power supplying this equipment before working on or inside equipment. Lock the switchgear in the isolated position.                  ■ Always use a properly rated voltage sensing device to confirm power is off.                  ■ Install safety barriers and display a danger sign.                  ■ Replace all devices, doors, and covers before turning on power to this equipment.  <b>Failure to follow these instructions will result in death or serious injury.</b></p>	<p><b>RISQUE D'ÉLECTROCUTION, D'EXPLOSION OU D'ARC ÉLECTRIQUE</b>                  ■ Portez un équipement de protection personnelle adapté et respectez les consignes de sécurité électrique courantes. Reportez-vous aux normes NFPA 70E, CSA Z462 ou aux textes équivalents applicables dans votre région du monde.                  ■ Seul un personnel qualifié doit effectuer l'installation et l'entretien de cet appareil.                  ■ Débranchez toutes les sources d'alimentation de cet équipement avant d'effectuer toute opération interne ou externe sur celui-ci. Verrouillez l'appareillage en position isolée.                  ■ Utilisez toujours un dispositif de détection de tension ayant une valeur nominale appropriée pour vous assurer que l'alimentation est coupée                  ■ Installez des barrières de sécurité et affichez un signal de danger.                  ■ Remettez en place tous les équipements, les portes et les capots avant de remettre l'appareil sous tension.  <b>Le non-respect de ces instructions provoquera la mort ou des blessures graves.</b></p>	<p><b>PELIGRO DE DESCARGA ELÉCTRICA, EXPLOSIÓN O ARCO ELÉCTRICO</b>                  ■ Utilice el equipo de protección personal (PPE) adecuado y siga las recomendaciones para el trabajo seguro con dispositivos eléctricos. Consulte NFPA 70E, CSA Z462 o la norma local equivalente.                  ■ Solo el personal de electricidad cualificado podrá instalar, programar y realizar el mantenimiento del equipo.                  ■ Desconecte toda la alimentación de este equipo antes de trabajar en él o en su interior. Bloquee la aramata eléctrica en la posición de aislamiento.                  ■ Utilice siempre un dispositivo de detección de tensión de capacidad adecuada para confirmar la ausencia de alimentación eléctrica.                  ■ Instale barreras de seguridad y coloque un cartel de peligro.                  ■ Vuelva a colocar todos los dispositivos, las puertas y las tapas antes de conectar la alimentación de este equipo.  <b>Si no se siguen estas instrucciones provocará lesiones graves o incluso la muerte.</b></p>	<p>电击、爆炸或电弧闪光危险                  ■ 采用适当的个人防护设备 (PPE) 并遵循电气作业安全守则。请参阅 NFPA 70E, CSA Z462 或当地对应的标准。                  ■ 只有具备相应资质的电气人员才能安装和维修该设备。                  ■ 在该设备表面或内部工作之前, 请关闭设备的全部电源。将开关锁定在隔离位置。                  ■ 确保使用合适的额定电压传感器确认电源已关闭。                  ■ 安装安全栅并显示危险标志。                  ■ 更换所有设备、门和盖, 然后再打开该设备的电源。                  不遵循上述说明将导致人员伤亡。</p>
<p><b>GEFAHR VON ELEKTRISCHEM SCHLAG, EXPLOSION ODER LICHTBOGEN</b>                  ■ Tragen Sie persönliche Schutzausrüstung (PSA) und befolgen Sie sichere Verfahren im Umgang mit Elektrogeräten. Siehe NFPA 70E, CSA Z462 oder lokale Entsprechung.                  ■ Diese Geräte dürfen nur von qualifizierten Elektrikern installiert und gewartet werden.                  ■ Schalten Sie vor Arbeiten am bzw. im Innern des Geräts die gesamte Spannungsversorgung ab. Die Schaltanlage in die Trennstellung bringen.                  ■ Verwenden Sie für die Prüfung vorhandener Spannung stets einen Spannungsfühler mit zutreffender Bemessungsspannung.                  ■ Bringen Sie Sicherheitsbarrieren und einen Warnhinweis an.                  ■ Bringen Sie alle Vorrichtungen, Türen und Abdeckungen wieder an, bevor Sie das Gerät einschalten.  <b>Die Nichtbeachtung dieser Anweisungen führt zu Tod oder schwereren Verletzungen.</b></p>	<p><b>RISCHIO DI FOLGORAZIONE, ESPLOSIONI O ARCO ELETTRICO</b>                  ■ Utilizzare dispositivi di protezione individuale (DPI) idonei e adottare misure di sicurezza adeguate per lavori elettrici. Vedere le normative NFPA 70E, CSA Z462 o le norme equivalenti nel paese di installazione.                  ■ Installazione e manutenzione di questa apparecchiatura si devono affidare solo ad elettricisti qualificati.                  ■ Prima di lavorare con l'apparecchiatura o al suo interno isolare completamente l'alimentazione elettrica. Bloccare l'interruttore in posizione isolata.                  ■ Per verificare che l'alimentazione sia isolata usare sempre un rilevatore di tensione correttamente tarato.                  ■ Installare barriere di sicurezza e apporre un segnale di pericolo.                  ■ Sostituire dispositivi, sportelli e coperture prima di riaccendere l'alimentazione dell'apparecchiatura.  <b>Il mancato rispetto di queste istruzioni provocherà morte o gravi infortuni.</b></p>	<p><b>RISCO DE ELECTROCUSSÃO, DE EXPLOSIÃO, OU DE ARCO ELÉCTRICO</b>                  ■ Utilize equipamento de protecção pessoal (PPE) e siga os métodos de segurança eléctrica. Consulte NFPA 70E, CSA Z462 ou o equivalente local.                  ■ A instalação e manutenção deste equipamento só devem ser efectuadas por electricistas qualificados.                  ■ Desligue todas as fontes de alimentação deste equipamento antes de trabalhar no equipamento ou no seu interior. Bloquee a placa de distribuição na posição isolada.                  ■ Utilize sempre um dispositivo de detecção da tensão nominal adequada para confirmar se a alimentação está desligada.                  ■ Instale barreiras de segurança e apresente um sinal de perigo.                  ■ Substitua todos os dispositivos, portas e tampas antes de ligar a alimentação deste equipamento.  <b>A não observância destas instruções resultará em morte, ou ferimentos graves.</b></p>	<p><b>ОПАСНОСТЬ ПОРАЖЕНИЯ ЭЛЕКТРИЧЕСКИМ ТОКОМ, ВЗРЫВА ИЛИ ВСПЫШКИДУГИ</b>                  ■ Используйте подходящие средства индивидуальной защиты (СИЗ) и соблюдайте технику безопасности при электротехнических работах. См. NFPA 70E, CSA Z462 или местный эквивалентный стандарт.                  ■ Данное оборудование могут устанавливать и обслуживать только квалифицированные электрики.                  ■ Отключите питание до начала работы снаружи или внутри оборудования.                  ■ Переведите переключатель в изолированное положение.                  ■ Всегда пользуйтесь надлежащим датчиком номинального напряжения для определения отсутствия питания.                  ■ Установите защитные ограждения и знак опасности.                  ■ Установите обратно все устройства, дверцы и крышки перед включением питания данного оборудования.  <b>Несоблюдение этих инструкций приведет к смерти или серьезной травме.</b></p>

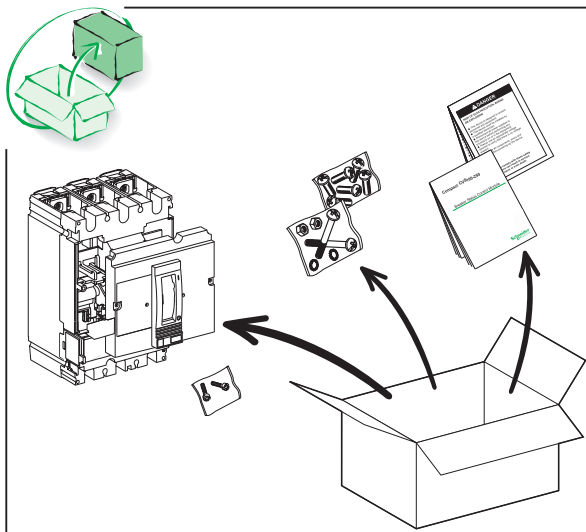

<b>100 A</b>	
<b>3P</b> 6 (M6 x 20)	
<b>4P</b> 8 (M6 x 20)	
<b>3P</b> 2 (M5 x 70)	
<b>4P</b> 4 (M5 x 70)	

<b>160/250 A</b>	
<b>3P</b> 6 (M8 x 20)	
<b>4P</b> 8 (M8 x 20)	
<b>3P</b> 2 (M5 x 70)	
<b>4P</b> 4 (M5 x 70)	

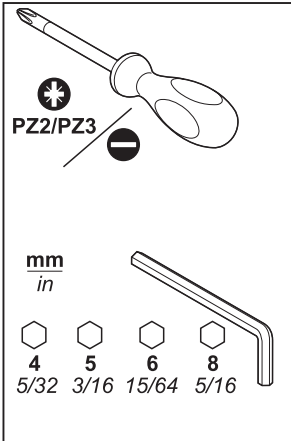

**i** Avoid foreign matter dropping in  
Interdit de tomber de corps étrangers  
Evitar la caída de cuerpos extraños  
禁止异物掉落  
Eindringen von Fremdkörpern verboten  
Evita la caduta di corpi estranei  
A proibição de corpos estranho  
Не допускается попадание посторонних предметов

The product's manufacture date is coded PP-YYYY-Www-D, where:  
 ● PP: plant code  
 ● YYYY: year of manufacture  
 ● Www: week of manufacture  
 ● D: weekday of manufacture (Monday = 1)  
 Eg: 7Q-2014-W19-3 = product manufactured at plant 7Q on Wednesday 7 May 2014

La date de fabrication du produit est codée PP-YYYY-Www-D, avec:  
 ● PP: code usine  
 ● YYYY: année de fabrication  
 ● Www: semaine de fabrication  
 ● D: jour de fabrication dans la semaine (lundi = 1)  
 Ex: 7Q-2014-W19-3= produit fabriqué le mercredi 7 mai 2014 par l'usine 7Q.

La fecha de fabricación del producto está codificada PP-YYYY-Www-D, donde:  
 ● PP: código de la planta  
 ● YYYY: año de fabricación  
 ● Www: semana de fabricación  
 ● D: día de la semana de fabricación (lunes = 1)  
 Ej: 7Q-2014-W19-3 = producto fabricado en la planta 7Q el miércoles 7 de mayo de 2014

产品制造日期采用如下代码 PP-YYYY-Www-D, 其中:  
 ● PP: 工厂代码  
 ● YYYY: 制造年份  
 ● Www: 第几周制造  
 ● D: 星期几制造 (星期一 = 1)  
 例如: 7Q-2014-W19-3 = 产品于 2014 年 5 月 7 日星期三在 7Q 工厂制造。

Das Herstellungsdatum des Produkts ist folgendermaßen codiert: PP-YYYY-Www-D. Wobei:  
 ● PP: Werkscode  
 ● YYYY: Herstellungsjahr  
 ● Www: Herstellungswoche  
 ● D: Herstellungstag (Montag = 1)  
 Z. B.: 7Q-2014-W19-3 = ein Produkt, das in Werk 7Q, am Mittwoch den 7. Mai, im Jahr 2014 gefertigt wurde.

La data di fabbricazione del prodotto è indicata con il codice PP-YYYY-Www-D, dove:  
 ● PP: codice stabilimento  
 ● YYYY: anno di fabbricazione  
 ● Www: settimana di fabbricazione  
 ● D: giorno della settimana in cui il prodotto è stato fabbricato (lunedì = 1)  
 Ad es. 7Q-2014-W19-3 = prodotto fabbricato presso lo stabilimento 7Q mercoledì 7 maggio 2014.

A data de fabrico do produto está sob a forma de código PP-YYYY-Www-D, onde:  
 ● PP: código da fábrica  
 ● YYYY: ano de fabrico  
 ● Www: semana de fabrico  
 ● D: dia da semana de fabrico (Segunda-feira = 1)  
 Ex: 7Q-2014-W19-3 = produto fabricado na fábrica 7Q na Quarta-feira 7 de Maio de 2014.

Дата производства продукта закодирована в формате PP-YYYY-Www-D, где:  
 ● PP: код завода  
 ● YYYY: год производства  
 ● Www: неделя производства  
 ● D: день недели, когда был произведен продукт (понедельник = 1)  
 Пример. 7Q-2014-W19-3 = продукт произведен на заводе 7Q в среду, 7 мая 2014 года.

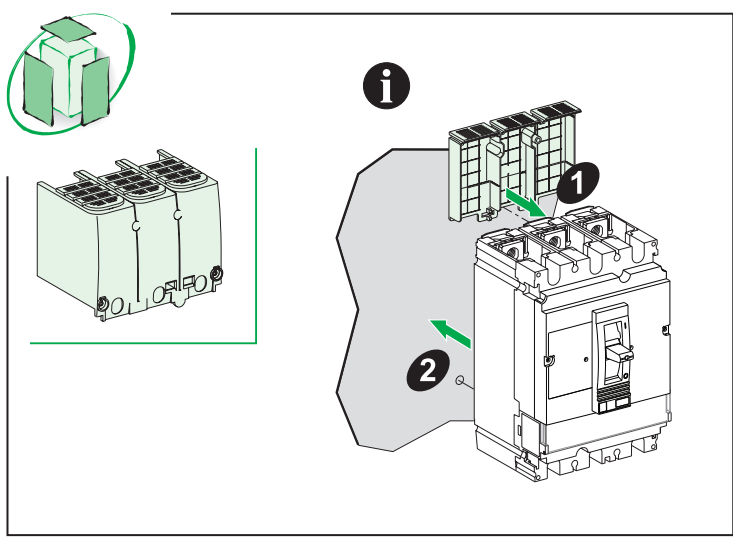
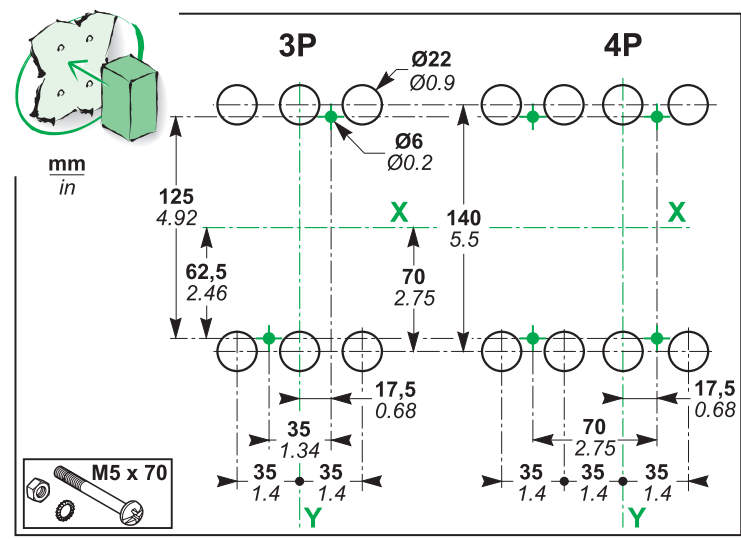
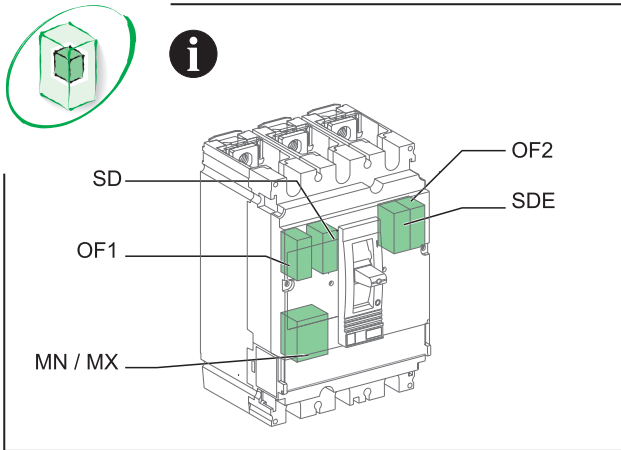
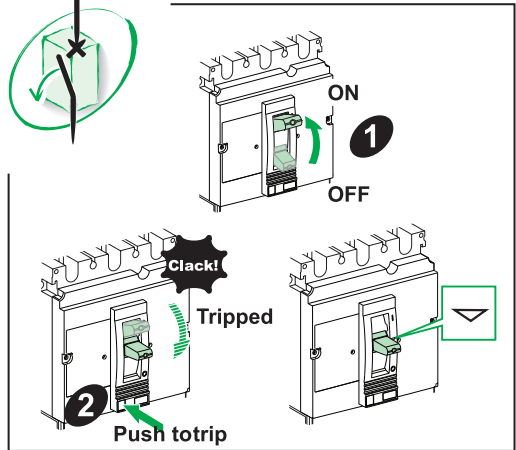
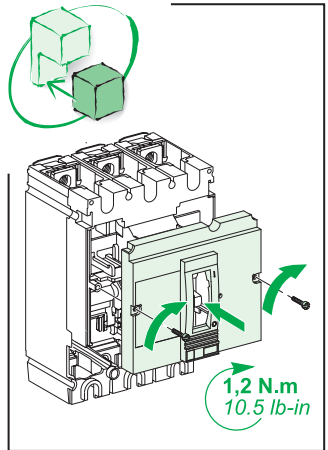



mm  
in

**100/160 A**

1,5...95 mm <sup>2</sup> AWG 16...4/0
x3 LV429242
x4 LV429243

25,4  
1

Acier  
Steel

≤ 160 A    > 160 A

S : 1,5...95 mm<sup>2</sup> Cu / Al  
S : AWG 16...4/0 Cu / Al

**i** 1,5...4 mm<sup>2</sup>  
AWG 16...12

1 2

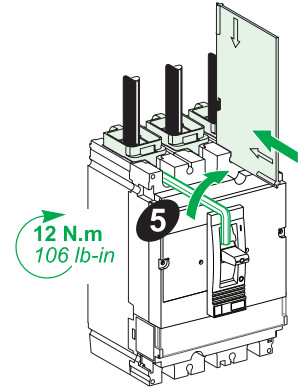
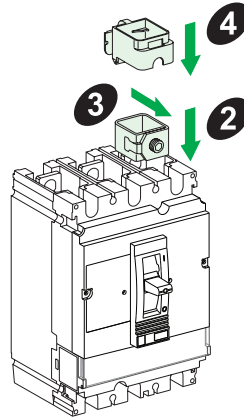
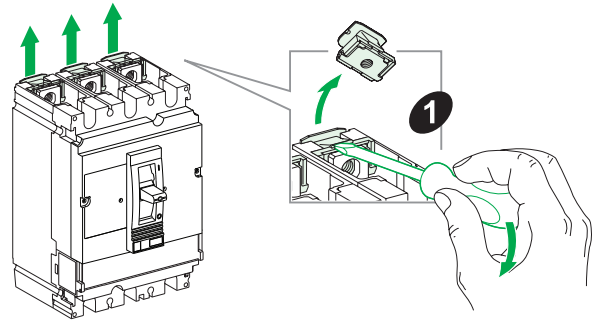

mm  
in

**100-250 A**

100-250 A	
25...95 mm <sup>2</sup> AWG 4...4/0	120...185 mm <sup>2</sup> 250...350 kcmil
x3 LV429227	LV429259
x4 LV429228	LV429260

25,4  
1

Aluminium  
Aluminium

15,5  
0.61

25,4  
1

12  
0.47

S : 25...50 mm<sup>2</sup> Cu / Al  
S : AWG 4...1/0 Cu / Al

S : 70...95 mm<sup>2</sup> Cu / Al  
S : AWG 2/0...4/0 Cu / Al

S : 120...185 mm<sup>2</sup> Cu / Al  
S : 250...350 kcmil Cu / Al

20 N.m  
180 lb-in

26 N.m  
225 lb-in

26 N.m  
225 lb-in

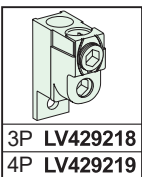
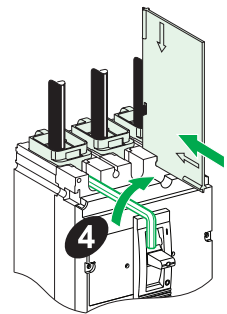
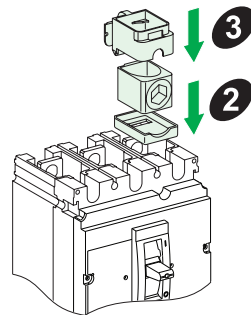
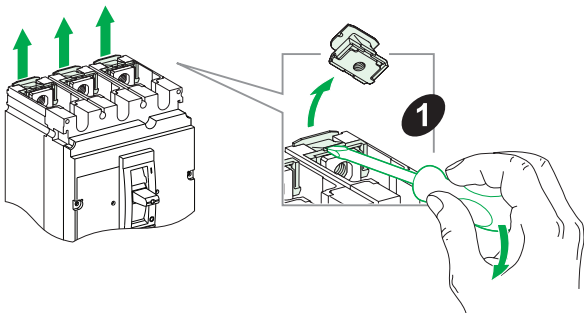

3P LV429218  
4P LV429219

mm  
in

50,8  
2

25,4  
1

22 N.m  
191 lb-in

S : 50...120 mm<sup>2</sup> Cu / Al  
S : AWG 1/0...250 kcmil Cu / Al

100 A    160-250 A

10 N.m  
88 lb-in

15 N.m  
130 lb-in

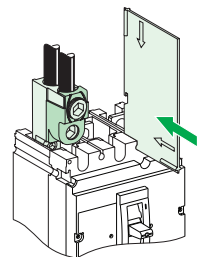

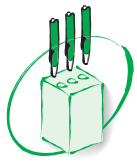

mm  
in

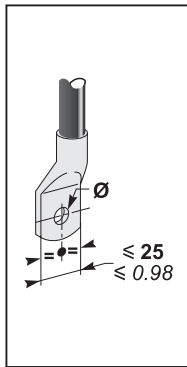
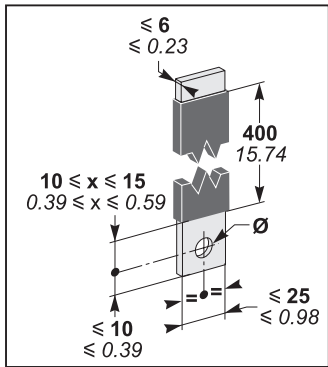
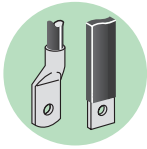

	100 A	160/250 A
$\emptyset$	$\geq 6$ $\geq 0.23$	$\geq 8$ $\geq 0.31$

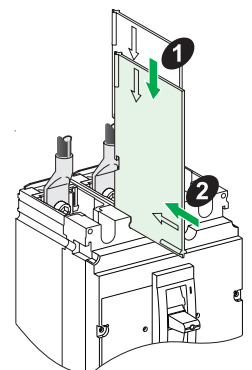
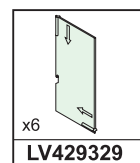
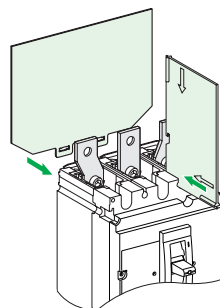
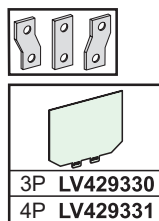
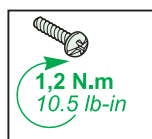
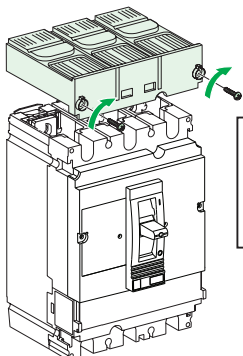
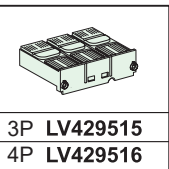
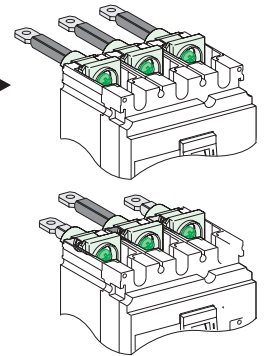
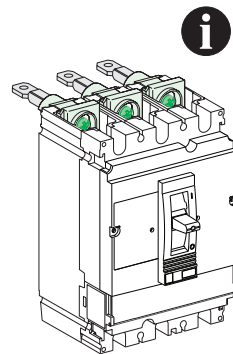
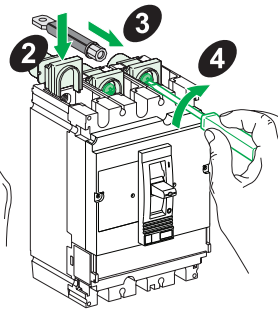
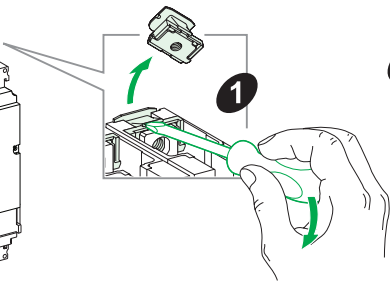
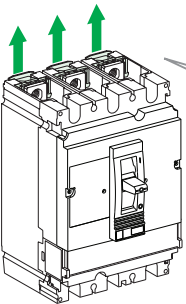
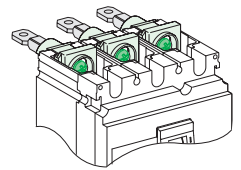
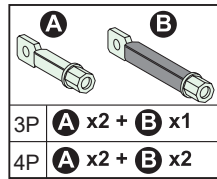
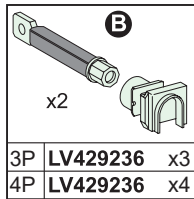
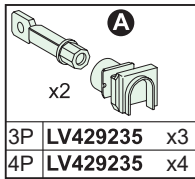
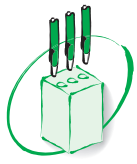
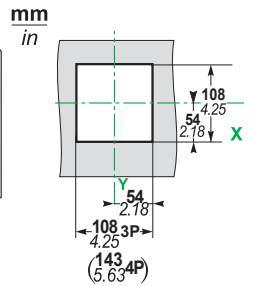
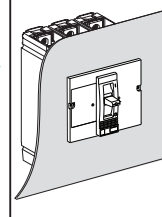
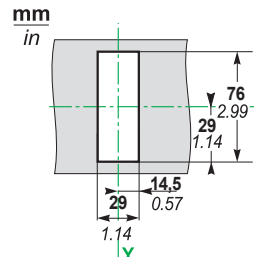
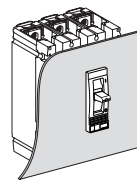
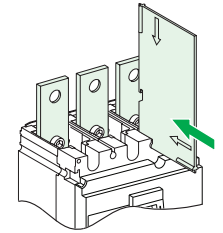
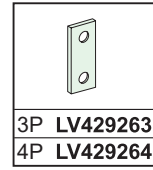
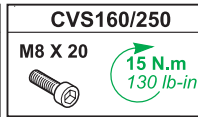
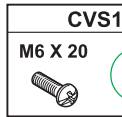
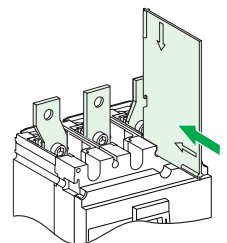
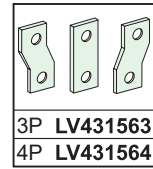
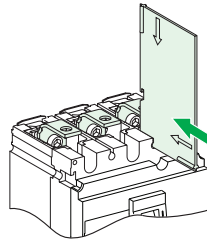
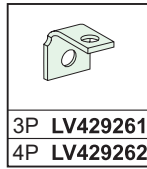
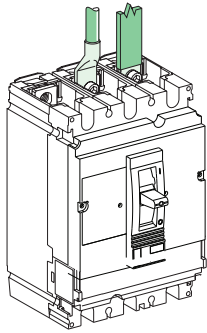



3P LV429517  
4P LV429518

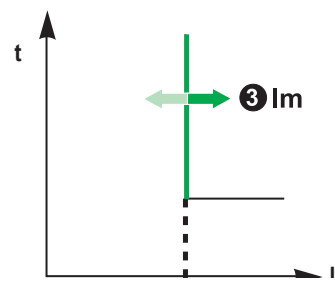
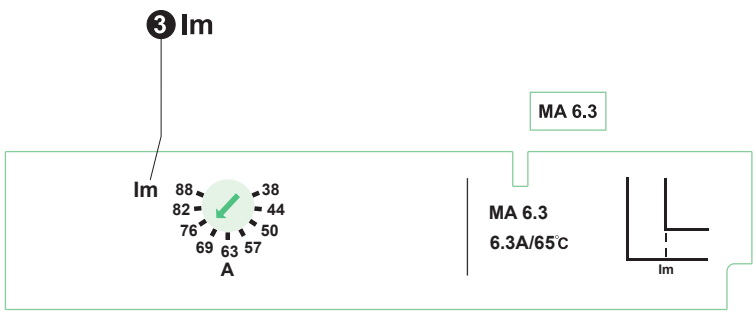
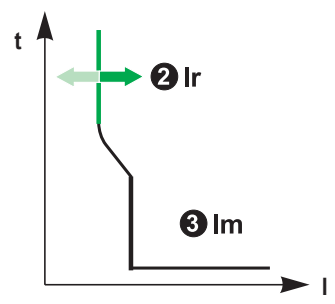
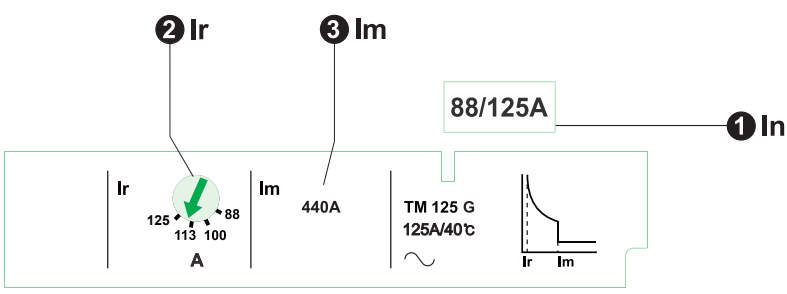
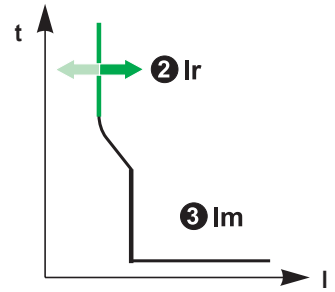
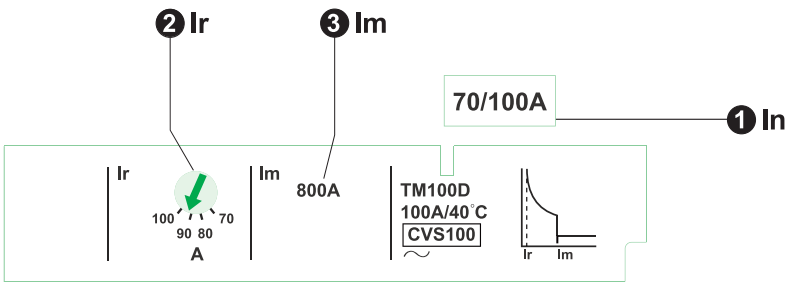
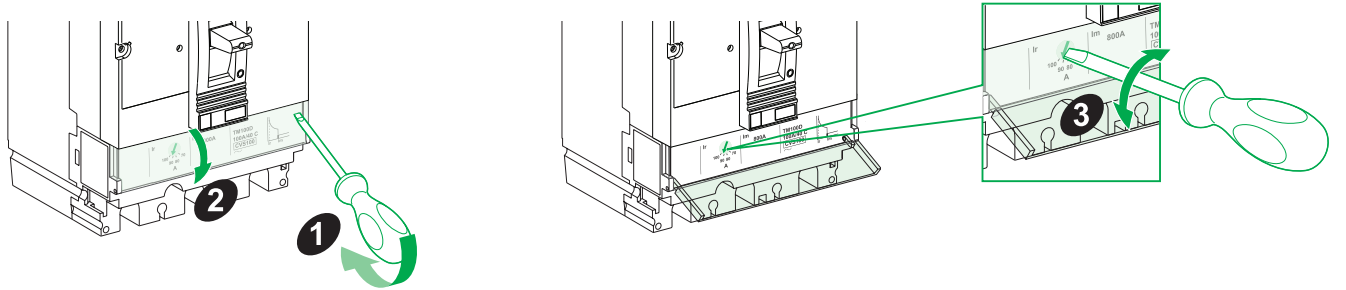
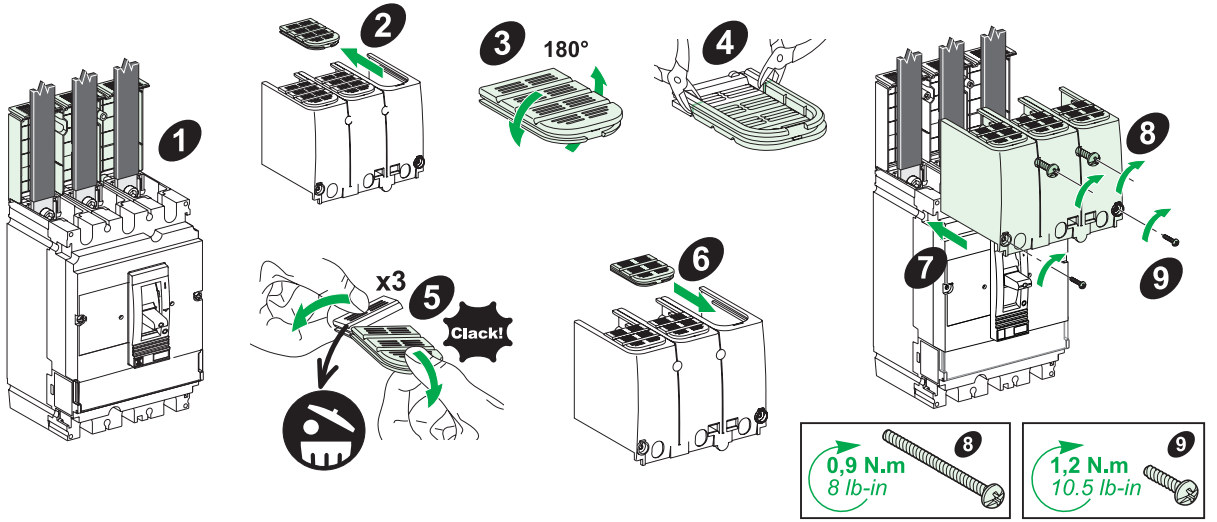

**Schneider Electric Industries SAS**

35, rue Joseph Monier  
CS30323  
92500 Rueil-Malmaison  
France

<http://www.schneider-electric.com>

**S1A19928-07-D03**



*Printed on recycled paper.*

Уполномоченный  
поставщик в РФ:  
АО «Шнейдер Электрик»  
Адрес:

127018, г. Москва, ул.  
Двинцев, д.12, корп.1,  
тел. +7 (495)777 99 88,  
факс: +7 (495)777 99 94, 8-800-200-6446  
[www.schneider-electric.ru](http://www.schneider-electric.ru)

