

loudity

SMT56



MATERIALS

Color - Black
Plastic Material - LCP
Terminal - SMD Type

Weight

approx. 0.1 gm.

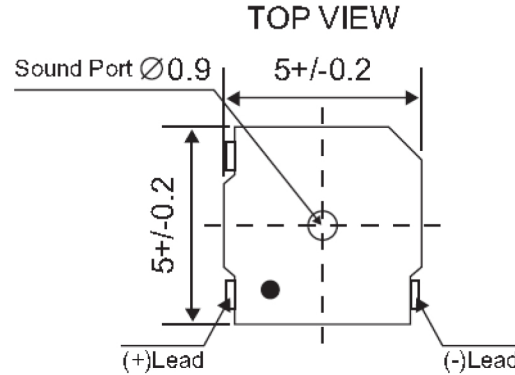

SIDE VIEW

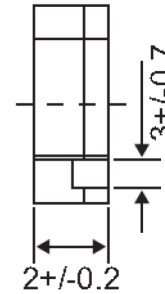

BOTTOM VIEW

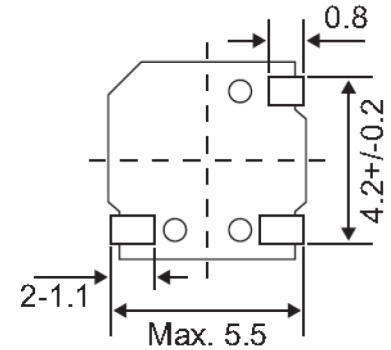

All dimensions are in mm
Unspecified Tolerance are ± 0.5 mm

Model	Unit	LD-BZEL-T56-0505
Operating Voltage	Vo-p	2 ~ 4
Rated Voltage	Vo-p	3
* Max. Rated Current	mA.	100
Coil Resistance	ohm	12 +/- 2
* Min. Sound Output at 10cm	dBA	75
Resonant Frequency	Hz	4000
Operating Temperature	°C	-20 ~ +85