

loudity

SMT67



MATERIALS

Color - Black
Plastic Material - LCP
Terminal - SMD Type

Weight

approx. 0.5 gm.

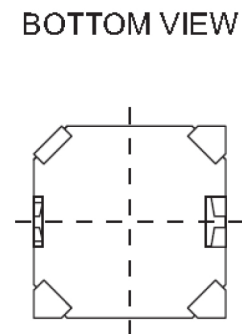
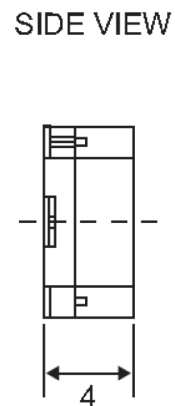
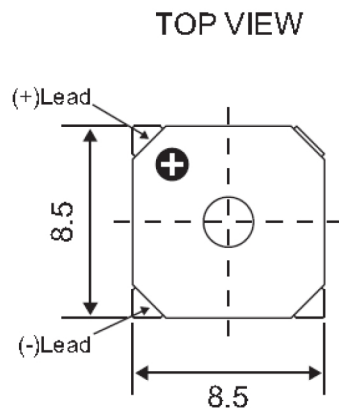

All dimensions are in mm
Unspecified Tolerance are +/-0.5mm

Model	Unit	LD-BZEL-T67-0808
Operating Voltage	Vo-p	2 ~ 4
Rated Voltage	Vo-p	3
* Max. Rated Current	mA.	80
Coil Resistance	ohm	16 +/- 3
* Min. Sound Output at 10cm	dBA	89
Resonant Frequency	Hz	2700
Operating Temperature	°C	-30 ~ +70