

REVISION RECORD				
REV	ECN	DESCRIPTION	DRFT	DATE

仅供参考图
 签字: 
 日期: 8/28/14
 (仅限内部使用, 对外无效)

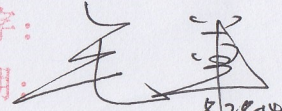
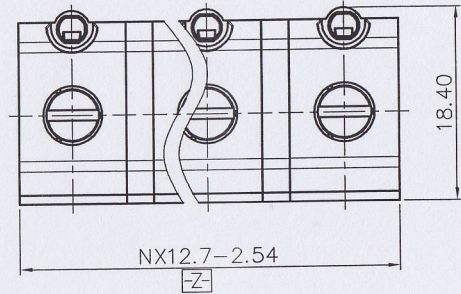

- NOTES:
- 1.DIMENSION SHALL BE INTERPRETED PER ASME Y14.5-2009.
 - 2.PITCH: 12.7MM POLES:N=2-XXP;
 - 3.RATED VOLTAGE/CURRENT: UL1059 600V/60A IEC 1000V/65A
 - 4.OPERATION TEMPERATURES: -40℃~+105℃
 - 5.WITHSTANDING VOLTAGE: AC3500V/1MIN.
 - 6.INSULATION RESISTANCE: 5000MΩ/DC1000V
 - 7.WIRE RANGE: 20~6AWG,2.5~16MM²
 - 8.TORQUE VALUE: M4.0,12.24kgf.cm
 - 9.UNDIMENSIONED TOLERANCES:

PITCH RANGE		NOMINAL DIMENSION RANGE				
IN MM		IN MM				
OVER 6 TO 10	OVER 10 TO 24	OVER 30 TO 60	OVER 60 TO 100	OVER 100 TO 150	OVER 150	□
±0.10	±0.15	±0.25	±0.20	±0.30	±0.5	±1.00
						0.05/10

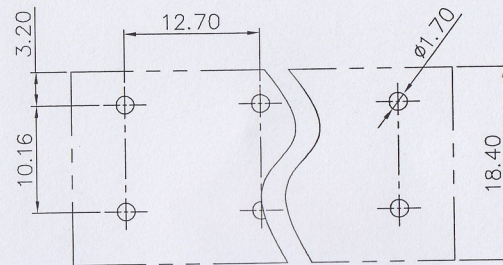
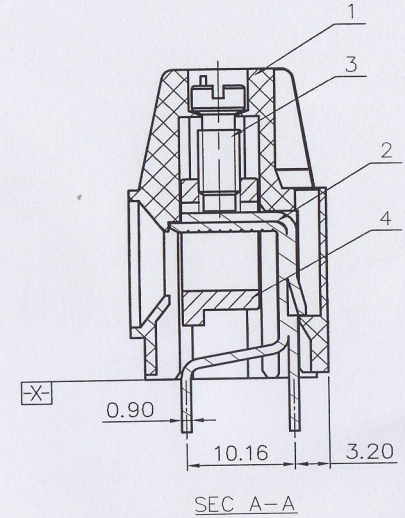
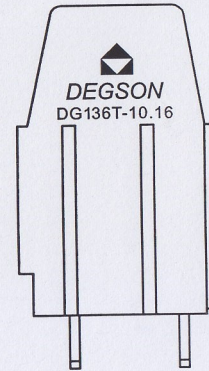
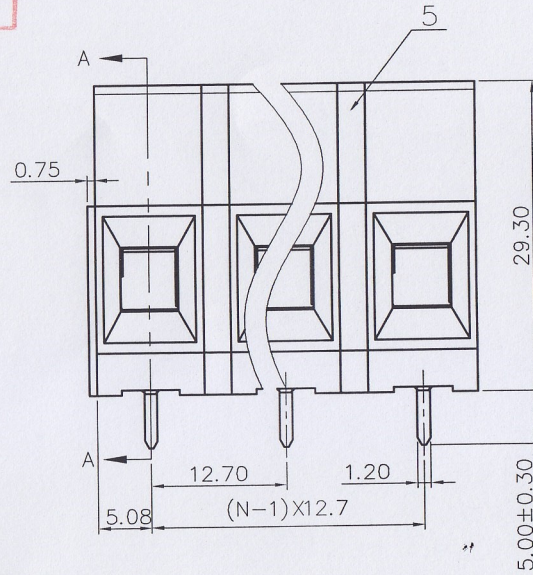
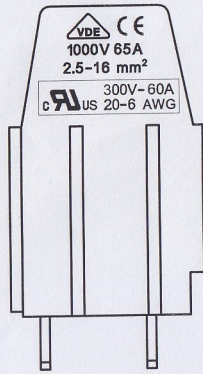

P.C.B LAYOUT

ITEM	NAME OF PART	NO. OF PART	Q'TY	MATERIAL	NOTES
5	DG136T Clapboard	4115HOY01A(H)	XX-1	PA66	UL94V-0
4	PC10-PE BRASS CAGE	X000001290(H)	XX	BRASS	Ni Plated
3	PC6 M4-SCREW	S000001490(H)	XX	BRASS	Ni Plated
2	DG136T-10A PIN HEADER	4115B00020(H)	XX	COPPER	Sn Plated
1	DG136T HOUSING	4115AOY01C(H)	XX	PA66	UL94V-0

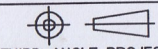
DETACHED LISTS	TOLERANCES EXCEPT AS NOTED .X ± .X' ± .XX ± .XX' ± .XXX ± .XXX' ±		MATERIAL: DEGSON 宁波高正电子有限公司 FINISH: DEGSON ® DEGSON ELECTRONICS CO., LTD PART NO.: NAME: DG136T-12.7-XXP-1Y-00A(H)	
	ANGLES ± 1° 		APPD: TITLE: ASSEMBLY DRAWING REV TO-1	
	THIRD ANGLE PROJECTION		CHKD: Aaron 8/28/14 DRFT: YJZ 07/31/14" DO NOT SCALE DRAWING SCALE 1:1 SHEET 1/1	