

### ◆ 型号说明书 Ordering Information

### ◆ 技术特性 Specification

RTS-01-206-20VP

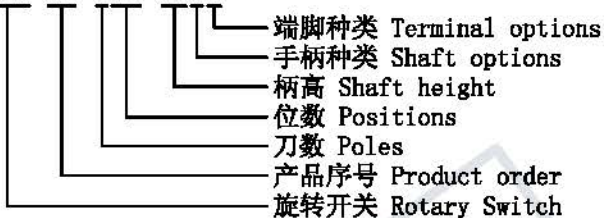

1. 规格 Rating: 0.3A 125VAC; 0.15A 250VAC
2. 接触电阻 Contact Resistance: 20mΩ max
3. 绝缘电阻 Insulation Resistance: 500VDC 100mΩmin
4. 耐电压 Dielectric Strength: 1000VAC, 1Minute
5. 操作温度 Operating Temperature: -25 °C ~ +85 °C
6. 电气寿命 Electrical Life: 10,000 Cycles

#### □ 电路特性 Circuitry trait

刀数 Poles	位数 Positions
1	00(12 POS. NO STOPS), 01, 02, 03, 04, 05, 06, 07, 08, 09, 10, 11, 12
2	00(6 POS. NO STOPS), 01, 02, 03, 04, 05, 06
3	00(4 POS. NO STOPS), 01, 02, 03, 04
4	00(3 POS. NO STOPS), 01, 02, 03

(30° index, Non-shorting contacts)



#### □ 安装尺寸及电路图 Schematics & p. c. mounting

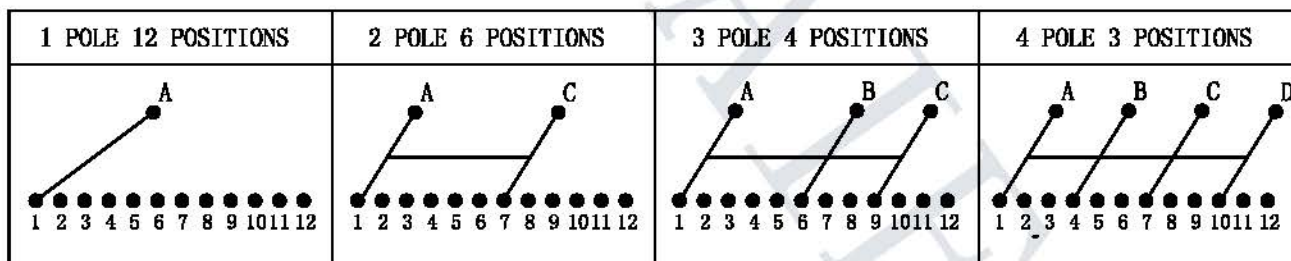
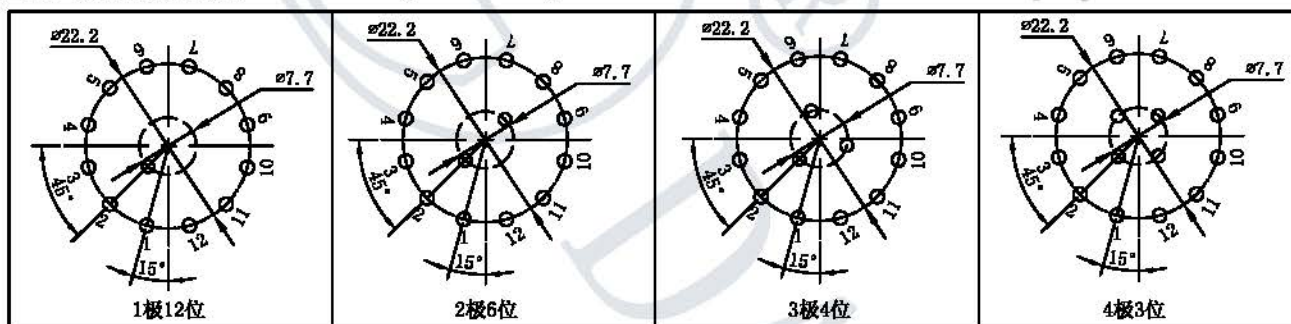

#### □ 外形图形 Outline Drawing

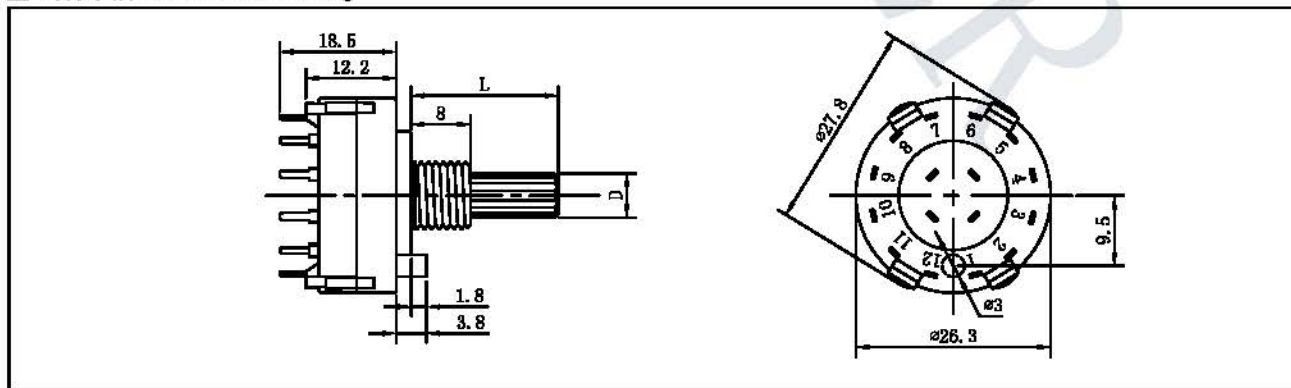

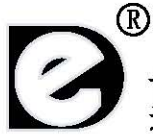

手柄种类 Shaft options

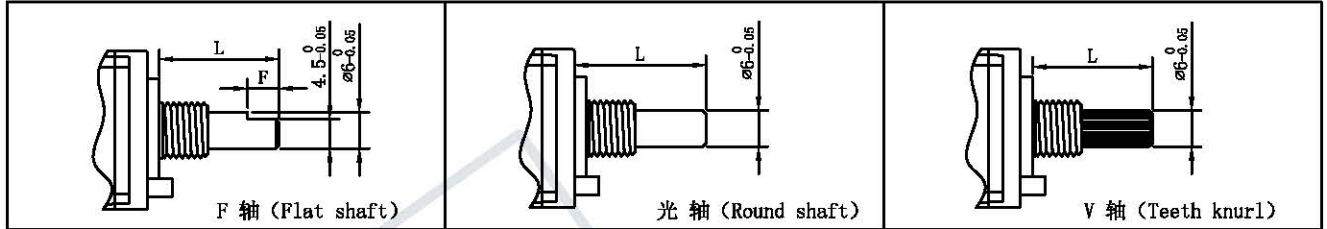

可选轴型 Actuator options

类型 Types		轴长 L Length of shaft		15	18	19	20	21	25	30	35	38	50	
		光柄 Round type	F (扁柄) Flat shaft											
轴柄 Types of shaft	光柄 Round type	ø6.0		●		●						●	●	
		ø6.3										●		
	F (扁柄) Flat shaft	ø6.0	●				●						●	
		ø6.3	●	●			●						●	
	V (拉花) Teeth knurl	ø6.0	●		●	●			●	●	●			
		ø6.3												

端脚种类 Terminal options

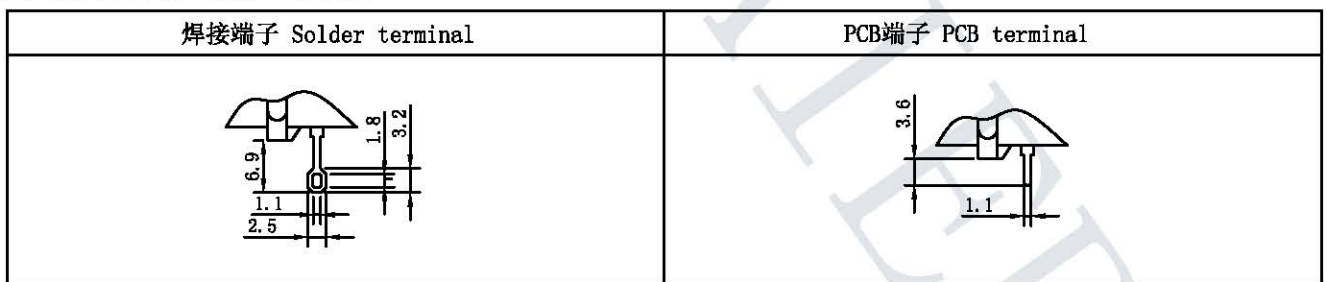

焊接 Soldering

焊接操作应在尽可能短的时间内完成，焊烙铁触点的最高温度和允许时间最好低于260° C，3秒钟以内。  
Soldering operation must be completed in a time as soon as possible suggested maximum solder-iron tip temperature and allowable time is at 235° C for 3 second