

Optocoupler, Phototransistor Output, With Base Connection

Features

- Isolation Test Voltage (1.0 s), 5300 V_{RMS}
- V_{CEsat} = 0.25 (≤ 0.4) V, I_F = 10 mA, I_C = 2.5 mA
- Built to conform to VDE Requirements
- High Quality Premium Device
- Long Term Stability
- Storage Temperature, - 55 °C to + 150 °C
- Lead (Pb)-free component
- Component in accordance to RoHS 2002/95/EC and WEEE 2002/96/EC

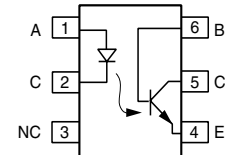
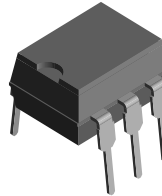

1179004

Agency Approvals

- UL1577, File No. E52744 System Code H or J, Double Protection
- DIN EN 60747-5-2 (VDE0884)
DIN EN 60747-5-5 pending
Available with Option 1
- CSA 93751
- BSI IEC60950 IEC60065

Description

The SFH600 is an optocoupler with a GaAs LED emitter which is optically coupled with a silicon planar phototransistor detector. The component is packaged in a plastic plug-in case, 20 AB DIN 41866.

The coupler transmits signals between two electrically isolated circuits. The potential difference between the circuits to be coupled should not exceed the maximum permissible insulating voltage.

Order Information

Part	Remarks
SFH600-0	CTR 40 - 80 %, DIP-6
SFH600-1	CTR 63 - 125 %, DIP-6
SFH600-2	CTR 100 - 200 %, DIP-6
SFH600-3	CTR 160 - 320 %, DIP-6
SFH600-0X007	CTR 40 - 80 %, SMD-6 (option 7)
SFH600-1X007	CTR 63 - 125 %, SMD-6 (option 7)
SFH600-1X009	CTR 63 - 125 %, SMD-6 (option 9)
SFH600-2X006	CTR 100 - 200 %, DIP-6 400 mil (option 6)
SFH600-2X007	CTR 100 - 200 %, SMD-6 (option 7)
SFH600-3X006	CTR 160 - 320 %, DIP-6 400 mil (option 6)
SFH600-3X007	CTR 160 - 320 %, SMD-6 (option 7)

For additional information on the available options refer to Option Information.

Absolute Maximum Ratings

T_{amb} = 25 °C, unless otherwise specified

Stresses in excess of the absolute Maximum Ratings can cause permanent damage to the device. Functional operation of the device is not implied at these or any other conditions in excess of those given in the operational sections of this document. Exposure to absolute Maximum Rating for extended periods of the time can adversely affect reliability.

Input

Parameter	Test condition	Symbol	Value	Unit
Reverse voltage		V _R	6.0	V
DC forward current		I _F	60	mA
Surge forward current	t _p = 10 μs	I _{FSM}	2.5	A
Total power dissipation		P _{diss}	100	mW

Output

Parameter	Test condition	Symbol	Value	Unit
Collector-emitter voltage		V_{CE}	70	V
Emitter-base voltage		V_{EB}	7.0	V
Collector current		I_C	50	mA
	$t = 1.0$ ms	I_C	100	mA
Power dissipation		P_{diss}	150	mW

Coupler

Parameter	Test condition	Symbol	Value	Unit
Isolation test voltage (between emitter and detector referred to climate DIN 40046, part2, Nov. 74)	$t = 1.0$ s	V_{ISO}	5300	V_{RMS}
Creepage			≥ 7.0	mm
Clearance			≥ 7.0	mm
Isolation thickness between emitter and detector			≥ 0.4	mm
Comparative tracking index per DIN IEC 112/VDE0303, part1			175	
Isolation resistance	$V_{IO} = 500$ V, $T_{amb} = 25$ °C	R_{IO}	$\geq 10^{12}$	Ω
	$V_{IO} = 500$ V, $T_{amb} = 100$ °C	R_{IO}	$\geq 10^{11}$	Ω
Storage temperature range		T_{stg}	- 55 to + 150	°C
Ambient temperature range		T_{amb}	- 55 to + 100	°C
Junction temperature	max. 10 s, dip soldering	T_j	100	°C
Soldering temperature	max. 10 s, dip soldering: distance to seating plane ≥ 1.5 mm	T_{sld}	260	°C

Electrical Characteristics

$T_{amb} = 25$ °C, unless otherwise specified

Minimum and maximum values are testing requirements. Typical values are characteristics of the device and are the result of engineering evaluation. Typical values are for information only and are not part of the testing requirements.

Input

Parameter	Test condition	Symbol	Min	Typ.	Max	Unit
Forward voltage	$I_F = 60$ mA	V_F		1.25	1.65	V
Breakdown voltage	$I_R = 10$ μ A	V_{BR}	6.0			V
Reverse current	$V_R = 6.0$ V	I_R		0.01	10	μ A
Capacitance	$V_F = 0$ V, $f = 1.0$ MHz	C_O		25		pF
Thermal resistance		R_{THJamb}		750		K/W

Output

Parameter	Test condition	Symbol	Min	Typ.	Max	Unit
Collector-emitter capacitance	$f = 1.0$ mHz, $V_{CE} = 5.0$ V	C_{CE}		5.2		pF
Collector - base capacitance	$f = 1.0$ mHz, $V_{CB} = 5.0$ V	C_{CB}		6.5		pF
Emitter - base capacitance	$f = 1.0$ mHz, $V_{CB} = 5.0$ V	C_{EB}		9.5		pF
Thermal resistance		R_{THJamb}		500		K/W



Coupler

Parameter	Test condition	Symbol	Min	Typ.	Max	Unit
Saturation voltage collector-emitter voltage	$I_F = 10 \text{ mA}$, $I_C = 2.5 \text{ mA}$	V_{CEsat}		0.25	0.4	V
Capacitance (input-output)		C_{IO}			0.6	pF

Current Transfer Ratio

Parameter	Test condition	Part	Symbol	Min	Typ.	Max	Unit
I_C/I_F at $V_{CE} = 5.0 \text{ V}$	$I_F = 10 \text{ mA}$	SFH600-0	CTR	40		80	%
		SFH600-1	CTR	63		125	%
		SFH600-2	CTR	100		200	%
		SFH600-3	CTR	160		320	%
	$I_F = 1.0 \text{ mA}$	SFH600-0	CTR	13	30		%
		SFH600-1	CTR	22	45		%
		SFH600-2	CTR	34	70		%
		SFH600-3	CTR	56	90		%
Collector-emitter leakage current	$V_{CE} = 10 \text{ V}$	SFH600-0	I_{CEO}		2.0	35	nA
		SFH600-1	I_{CEO}		2.0	35	nA
		SFH600-2	I_{CEO}		2.0	35	nA
		SFH600-3	I_{CEO}		5.0	70	nA

Switching Non-saturated

Parameter	Current	Rise time	Fall time	Turn-on time	Turn-off time	Cut-off frequency
Test condition	$V_{CC} = 5.0 \text{ V}$, $R_L = 75 \Omega$					
Symbol	I_F	t_r	t_f	t_{on}	t_{off}	F_{CO}
Unit	mA	μs	μs	μs	μs	kHz
	10	2.0	2.5	3.2	3.0	250

Switching Saturated

Parameter	Current	Rise time	Fall time	Turn-on time	Turn-off time
Symbol	I_F	t_r	t_f	t_{on}	t_{off}
Unit	mA	μs	μs	μs	μs
SFH600-0	20	2.5	11	3.7	19
SFH600-1	10	3.0	12	4.5	21
SFH600-2	10	3.0	12	4.5	21
SFH600-3	5.0	4.0	14	5.8	24

Typical Characteristics (Tamb = 25 °C unless otherwise specified)

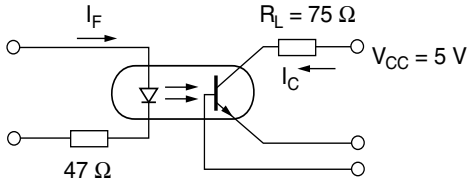

isth600_01

Figure 1. Linear Operation (without Saturation)

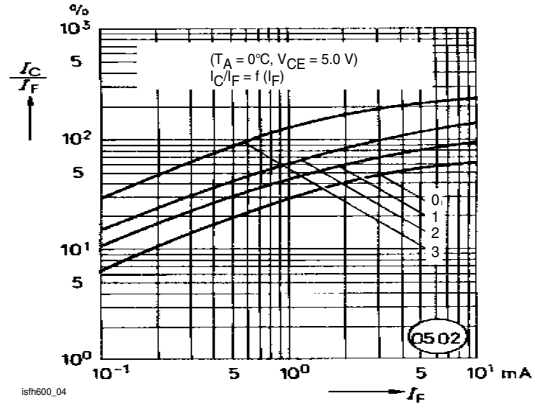

isth600_04

Figure 4. Current Transfer Ratio vs. Diode Current

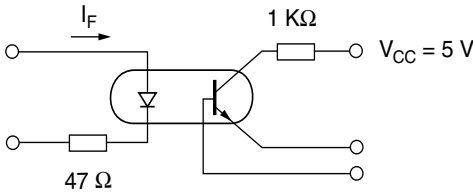

isth600_02

Figure 2. Switching Operation (with Saturation)

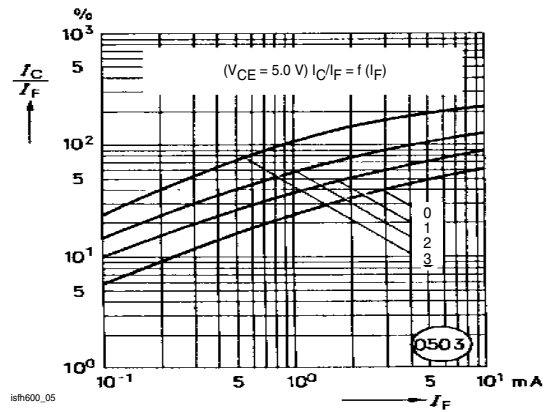

isth600_05

Figure 5. Current Transfer Ratio vs. Diode Current

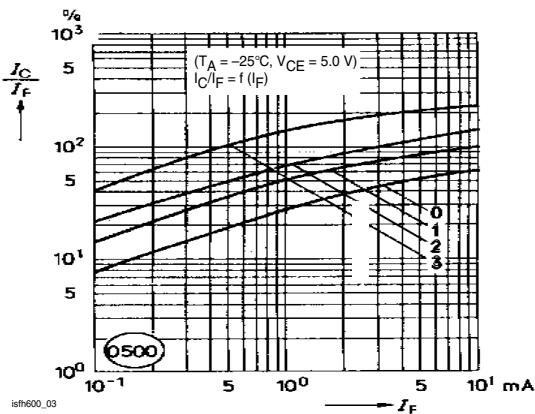

isth600_03

Figure 3. Current Transfer Ratio vs. Diode Current

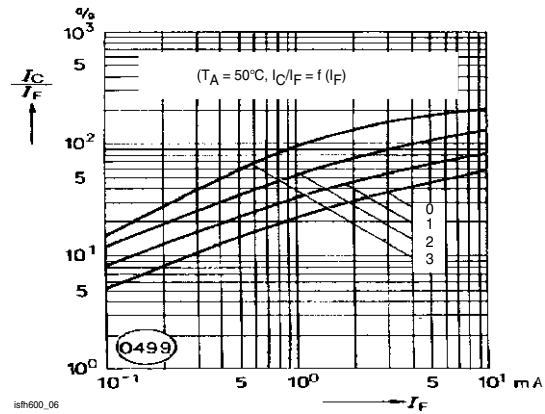

isth600_06

Figure 6. Current Transfer Ratio vs. Diode Current

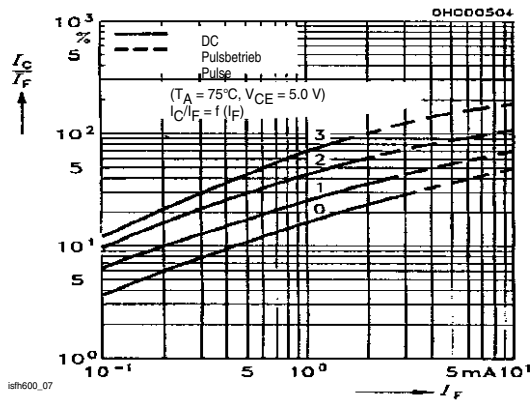

Figure 7. Current Transfer Ratio vs. Diode Current

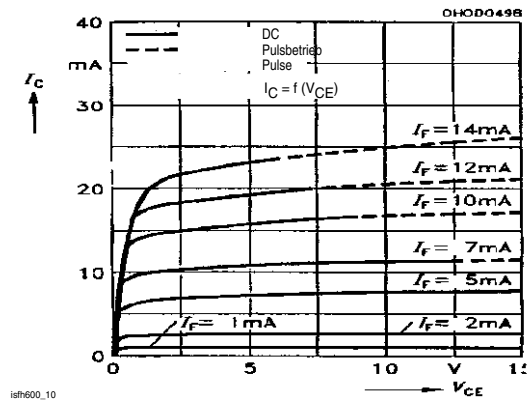

Figure 10. Output Characteristics SFH600-2, -3

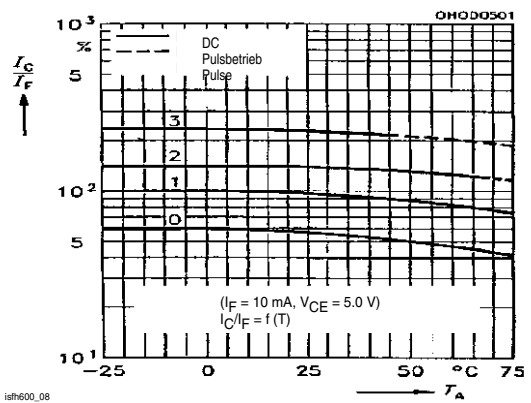

Figure 8. Current Transfer Ratio (CTR) vs. Temperature

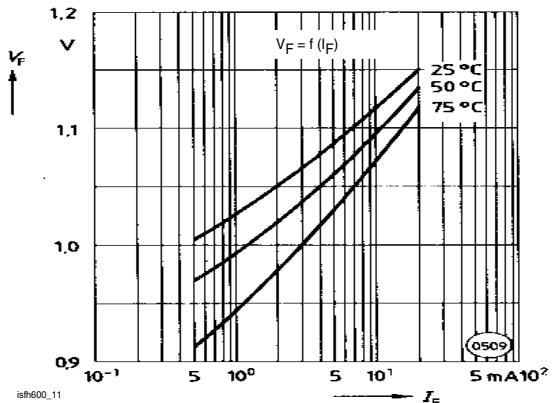

Figure 11. Forward Voltage

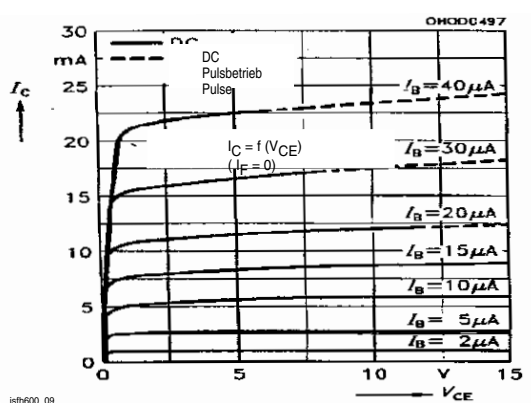

Figure 9. Transistor Characteristics SFH600-2, -3

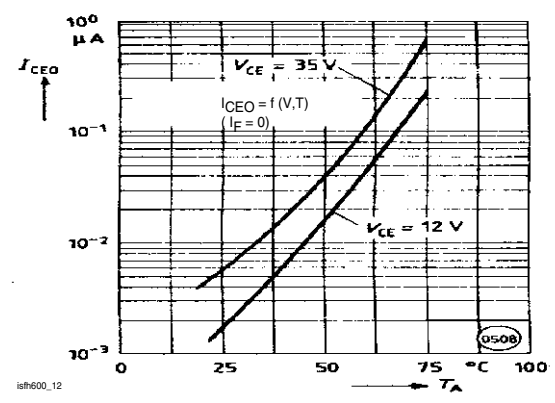

Figure 12. Collector-Emitter Off-state Current

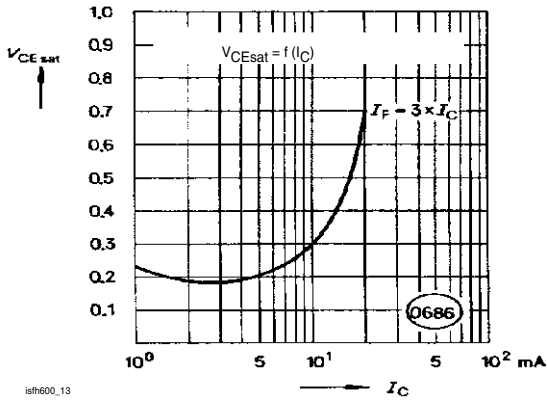

Figure 13. Saturation Voltage vs. Collector Current and Modulation Depth SFH600-0

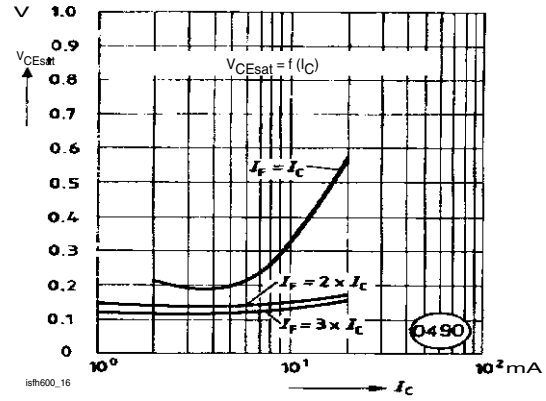

Figure 16. Saturation Voltage vs. Collector Current and Modulation Depth SFH600-3

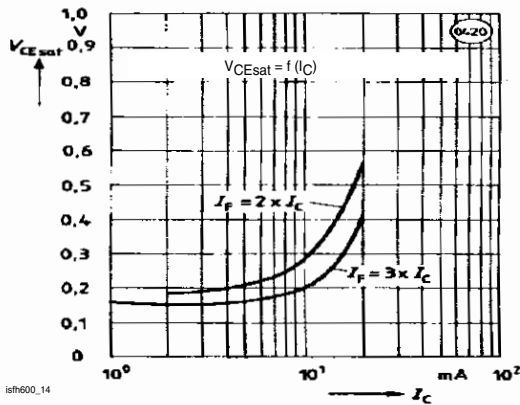

Figure 14. Saturation Voltage vs. Collector Current and Modulation Depth SFH600-1

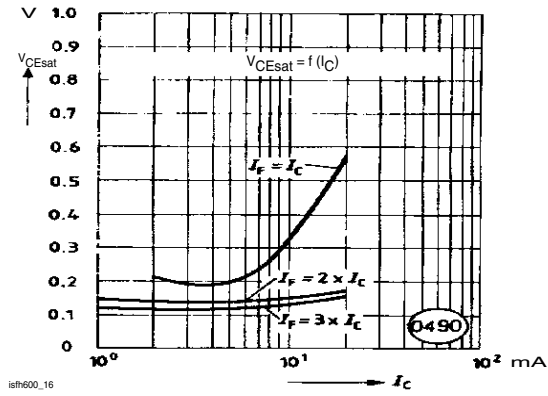

Figure 17. Permissible Pulse Load

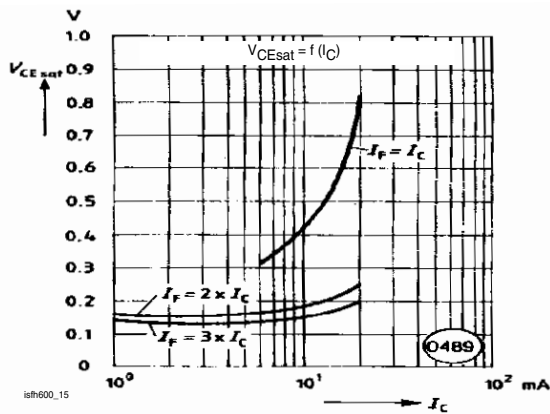

Figure 15. Saturation Voltage vs. Collector Current and Modulation Depth SFH600-2

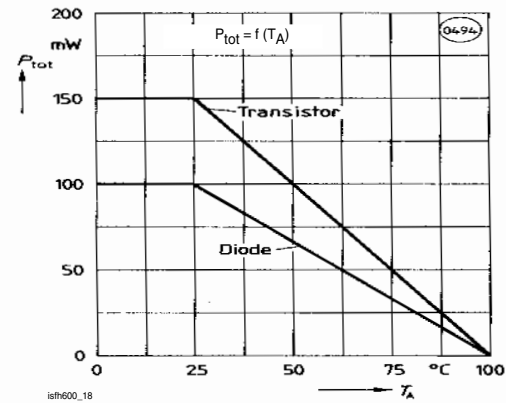

Figure 18. Permissible Power Dissipation for Transistor and Diode

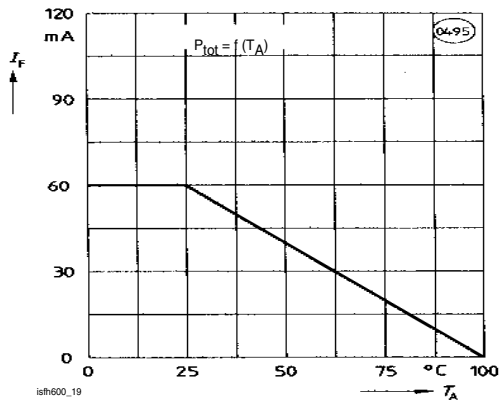

Figure 19. Permissible Forward Current Diode

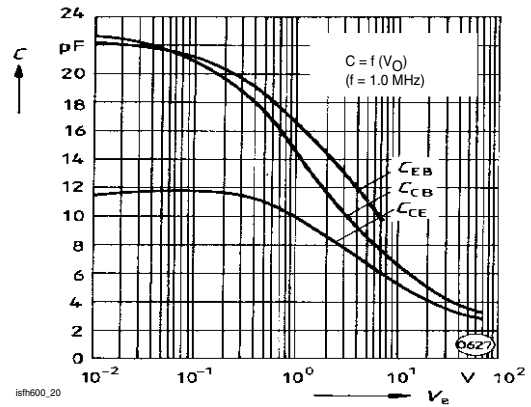
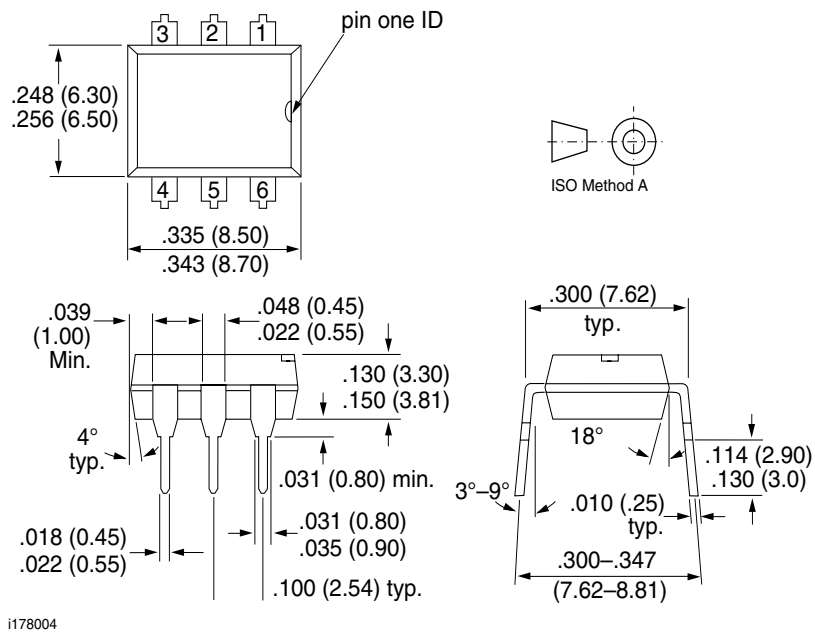

Figure 20. Transistor Capacitance

Package Dimensions in Inches (mm)



i178004

Option 6

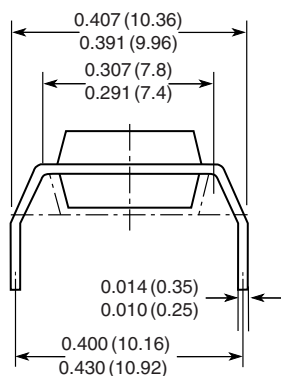

Option 7

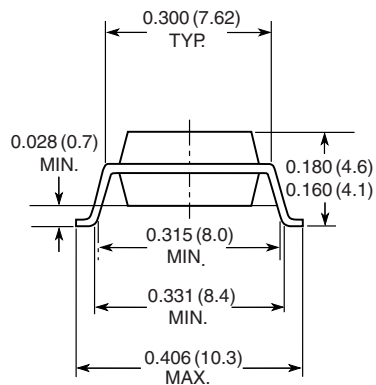

Option 9

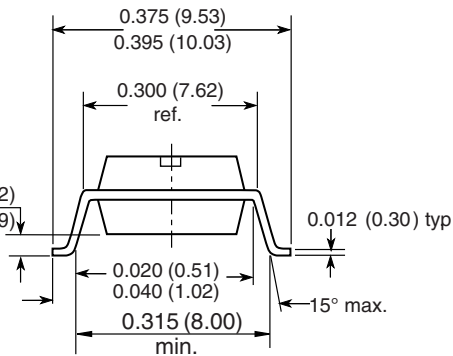

18450



Ozone Depleting Substances Policy Statement

It is the policy of Vishay Semiconductor GmbH to

1. Meet all present and future national and international statutory requirements.
2. Regularly and continuously improve the performance of our products, processes, distribution and operating systems with respect to their impact on the health and safety of our employees and the public, as well as their impact on the environment.

It is particular concern to control or eliminate releases of those substances into the atmosphere which are known as ozone depleting substances (ODSs).

The Montreal Protocol (1987) and its London Amendments (1990) intend to severely restrict the use of ODSs and forbid their use within the next ten years. Various national and international initiatives are pressing for an earlier ban on these substances.

Vishay Semiconductor GmbH has been able to use its policy of continuous improvements to eliminate the use of ODSs listed in the following documents.

1. Annex A, B and list of transitional substances of the Montreal Protocol and the London Amendments respectively
2. Class I and II ozone depleting substances in the Clean Air Act Amendments of 1990 by the Environmental Protection Agency (EPA) in the USA
3. Council Decision 88/540/EEC and 91/690/EEC Annex A, B and C (transitional substances) respectively.

Vishay Semiconductor GmbH can certify that our semiconductors are not manufactured with ozone depleting substances and do not contain such substances.

We reserve the right to make changes to improve technical design and may do so without further notice.

Parameters can vary in different applications. All operating parameters must be validated for each customer application by the customer. Should the buyer use Vishay Semiconductors products for any unintended or unauthorized application, the buyer shall indemnify Vishay Semiconductors against all claims, costs, damages, and expenses, arising out of, directly or indirectly, any claim of personal damage, injury or death associated with such unintended or unauthorized use.

Vishay Semiconductor GmbH, P.O.B. 3535, D-74025 Heilbronn, Germany



Notice

Specifications of the products displayed herein are subject to change without notice. Vishay Intertechnology, Inc., or anyone on its behalf, assumes no responsibility or liability for any errors or inaccuracies.

Information contained herein is intended to provide a product description only. No license, express or implied, by estoppel or otherwise, to any intellectual property rights is granted by this document. Except as provided in Vishay's terms and conditions of sale for such products, Vishay assumes no liability whatsoever, and disclaims any express or implied warranty, relating to sale and/or use of Vishay products including liability or warranties relating to fitness for a particular purpose, merchantability, or infringement of any patent, copyright, or other intellectual property right.

The products shown herein are not designed for use in medical, life-saving, or life-sustaining applications. Customers using or selling these products for use in such applications do so at their own risk and agree to fully indemnify Vishay for any damages resulting from such improper use or sale.