

Capacitor, Film, Metallized Polyester (Stacked), 1500 pF, +/-5% Tol, -55/+105C, General Purpose, 100 VDC@85C, Lead Spacing=5 mm

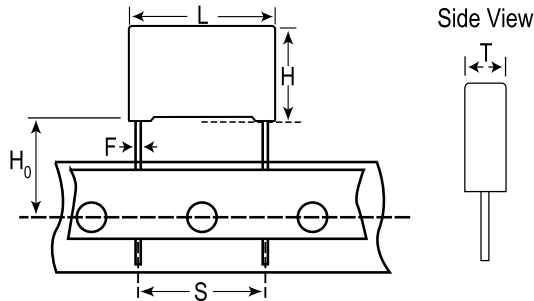

| General Information | |
|---------------------|--------------------------------|
| Supplier: | KEMET |
| Dielectric: | Metallized Polyester (Stacked) |
| Application: | General Purpose |
| Sub Application: | AEC-Q200 |
| Style: | Radial Box |
| Lead Form: | Wire Leads |
| Features: | Pulse |
| Approvals: | AEC-Q200 |
| RoHS: | Yes |

| Dimensions (mm) | | |
|-----------------|-----------|-----------|
| Symbol | Dimension | Tolerance |
| L | 7.2 | +0.2 |
| H | 6.5 | +0.1 |
| T | 2.5 | +0.1 |
| S | 5 | +/-0.4 |
| F | 0.5 | +/-0.05 |
| H0 | 18.5 | +/-0.5 |

| Specifications | |
|------------------------------|---|
| Capacitance: | 1500 pF |
| Voltage: | 100 VDC |
| Tolerance: | +/-5% |
| Voltage AC: | 63 VAC |
| Rated Temperature: | 85C |
| Temperature Range: | -55/+105C |
| Dissipation Factor @ 1 kHz: | 0.8% |
| Dissipation Factor @ 10 kHz: | 1.2% |
| Dissipation Factor @ 100kHz: | 2.5% |
| Insulation Resistance: | 15 GOhm |
| Inductance: | 7 |
| Maximum dVdT: | 200 v/us |
| Miscellaneous: | Above 85C DC And AC Voltage Derating Is 1.25%/C |

| Packaging Specifications | |
|--------------------------|--------------|
| Package Kind: | Ammo |
| Package Size: | 360x340x59mm |
| Package Quantity: | 3500 |