

KEMET Part Number: R82EC1330DQ50K

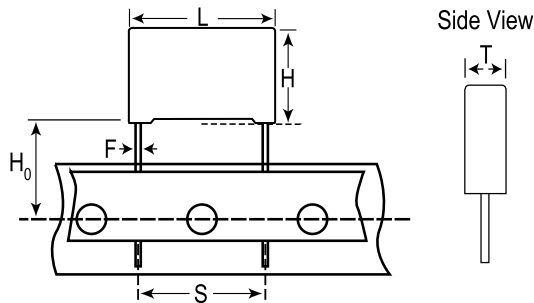

Capacitor, Film, Metallized Polyester (Stacked), 3300 pF, +/-10% Tol, -55/+105C, General Purpose, 100 VDC@85C, Lead Spacing=5 mm



General Information	
Supplier:	KEMET
Dielectric:	Metallized Polyester (Stacked)
Application:	General Purpose
Sub Application:	AEC-Q200
Style:	Radial Box
Lead Form:	Wire Leads
Features:	Pulse
Approvals:	AEC-Q200
RoHS:	Yes

Dimensions (mm)		
Symbol	Dimension	Tolerance
L	7.2	+0.2
H	6.5	+0.1
T	2.5	+0.1
S	5	+/-0.4
F	0.5	+/-0.05
H ₀	18.5	+/-0.5

Specifications	
Capacitance:	3300 pF
Voltage:	100 VDC
Tolerance:	+/-10%
Voltage AC:	63 VAC
Rated Temperature:	85C
Temperature Range:	-55/+105C
Dissipation Factor @ 1 kHz:	0.8%
Dissipation Factor @ 10 kHz:	1.2%
Dissipation Factor @ 100kHz:	2.5%
Insulation Resistance:	15 GOhm
Inductance:	7
Maximum dVdT:	200 v/us
Miscellaneous:	Above 85C DC And AC Voltage Derating Is 1.25%/C

Packaging Specifications	
Package Kind:	Ammo
Package Size:	360x340x59mm
Package Quantity:	3500

Statements of suitability for certain applications are based on our knowledge of typical operating conditions for such applications, but are not intended to constitute - and we specifically disclaim - any warranty concerning suitability for a specific customer application or use. This Information is intended for use only by customers who have the requisite experience and capability to determine the correct products for their application. Any technical advice inferred from this Information or otherwise provided by us with reference to the use of our products is given gratis, and we assume no obligation or liability for the advice given or results obtained.



© 2006-2016 IntelliData.net