

Silicon NPN Power Transistors

2SC3263

**DESCRIPTION**

- With TO-3PN package
- Complement to type 2SA1294

**APPLICATIONS**

- Audio and general purpose

**PINNING**

PIN	DESCRIPTION
1	Base
2	Collector;connected to mounting base
3	Emitter

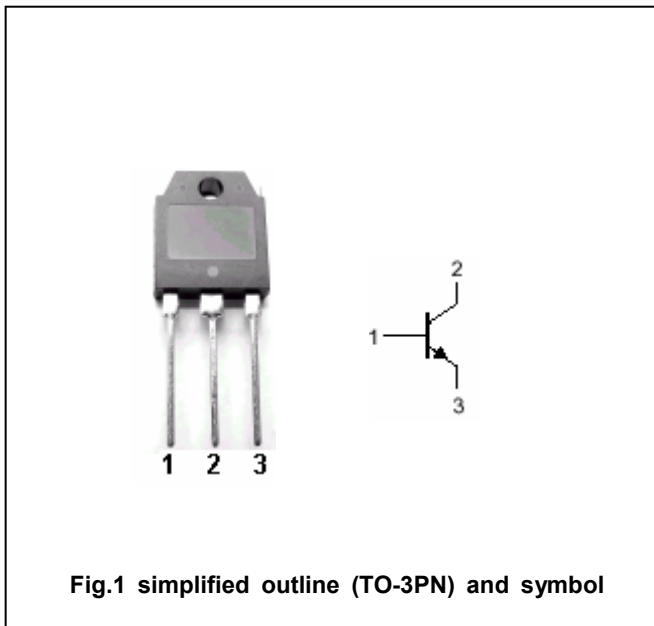

Fig.1 simplified outline (TO-3PN) and symbol

**Absolute maximum ratings(Ta=□)**

SYMBOL	PARAMETER	CONDITIONS	VALUE	UNIT
V <sub>CBO</sub>	Collector-base voltage	Open emitter	230	V
V <sub>CEO</sub>	Collector-emitter voltage	Open base	230	V
V <sub>EBO</sub>	Emitter-base voltage	Open collector	5	V
I <sub>C</sub>	Collector current		15	A
I <sub>B</sub>	Base current		4	A
P <sub>C</sub>	Collector power dissipation	T <sub>C</sub> =25□	130	W
T <sub>j</sub>	Junction temperature		150	□
T <sub>stg</sub>	Storage temperature		-55~150	□

## Silicon NPN Power Transistors

2SC3263

## CHARACTERISTICS

T<sub>j</sub>=25°C unless otherwise specified

SYMBOL	PARAMETER	CONDITIONS	MIN	TYP.	MAX	UNIT
V <sub>(BR)CEO</sub>	Collector-emitter breakdown voltage	I <sub>C</sub> =25mA ; I <sub>B</sub> =0	230			V
V <sub>CEsat</sub>	Collector-emitter saturation voltage	I <sub>C</sub> =5A I <sub>B</sub> =0.5A			2.0	V
I <sub>CBO</sub>	Collector cut-off current	V <sub>CB</sub> =230V; I <sub>E</sub> =0			100	μA
I <sub>EBO</sub>	Emitter cut-off current	V <sub>EB</sub> =5V; I <sub>C</sub> =0			100	μA
h <sub>FE</sub>	DC current gain	I <sub>C</sub> =5A ; V <sub>CE</sub> =4V	50		140	
C <sub>ob</sub>	Output capacitance	I <sub>E</sub> =0 ; V <sub>CB</sub> =10V; f=1MHz		250		pF
f <sub>T</sub>	Transition frequency	I <sub>C</sub> =2A ; V <sub>CE</sub> =12V		60		MHz

## Switching times

t <sub>on</sub>	Turn-on time	I <sub>C</sub> =5A; R <sub>L</sub> =12Ω I <sub>B1</sub> =- I <sub>B2</sub> =0.5A V <sub>CC</sub> =60V		0.3		μs
t <sub>s</sub>	Storage time			2.4		μs
t <sub>f</sub>	Fall time			0.5		μs

◆ h<sub>FE</sub> Classifications

O	Y
50-100	70-140

Silicon NPN Power Transistors

2SC3263

PACKAGE OUTLINE

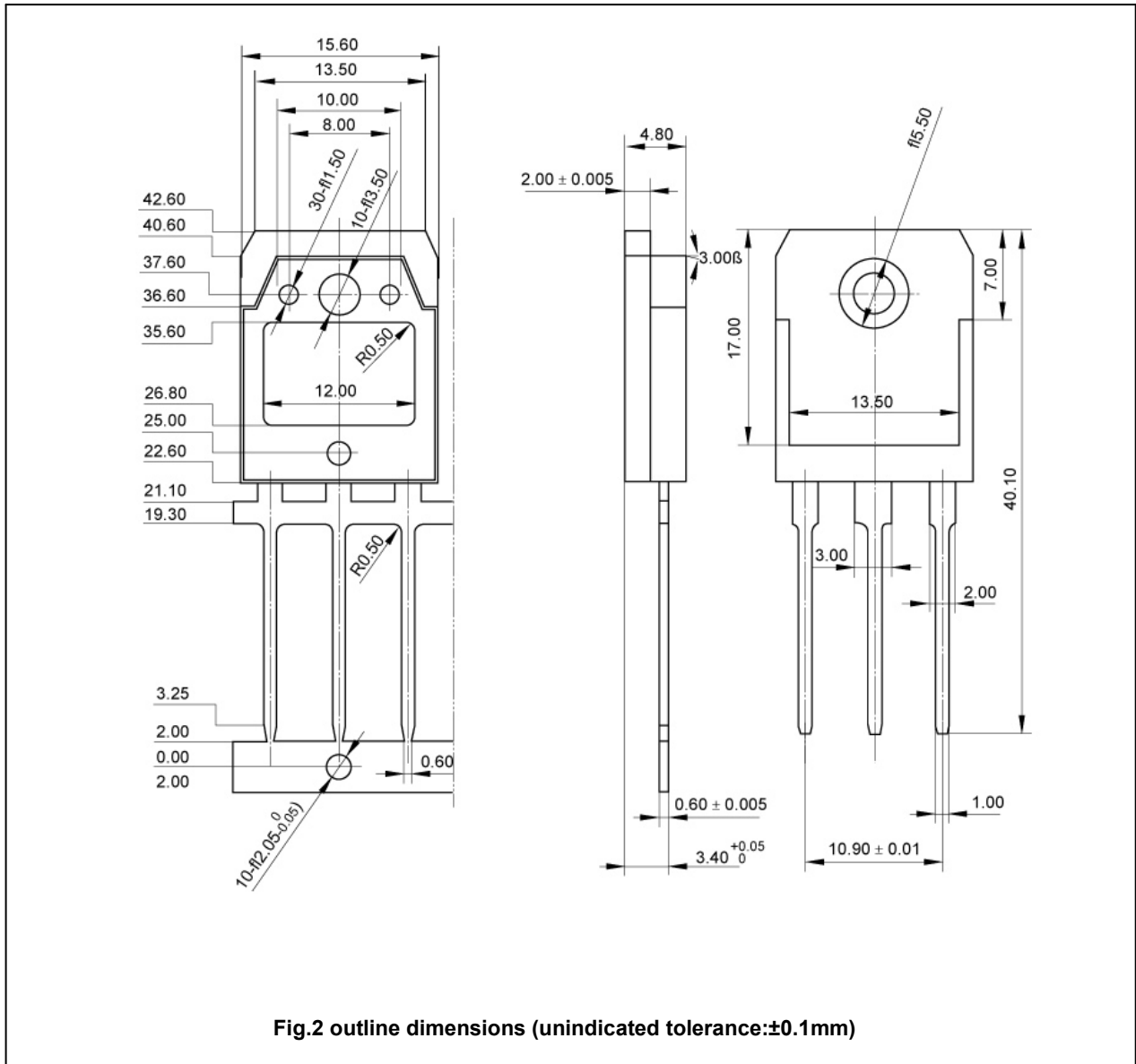

Fig.2 outline dimensions (unindicated tolerance:±0.1mm)

Silicon NPN Power Transistors

2SC3263

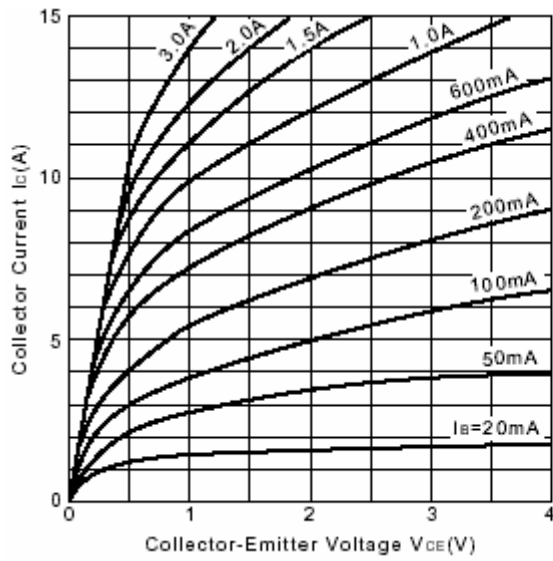

Fig.3 Static Characteristic

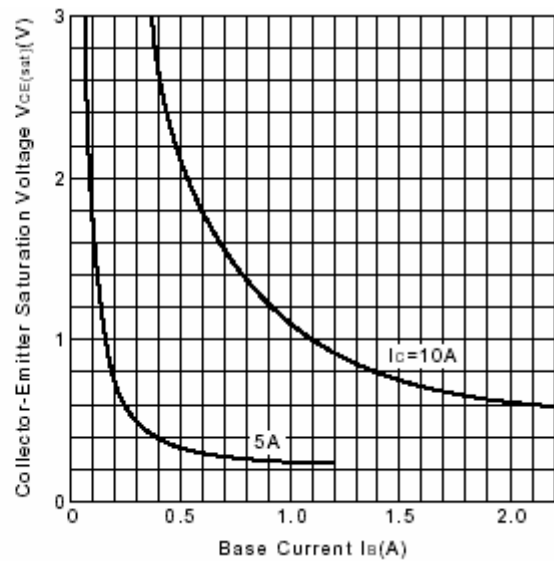

Fig.4  $V_{CE(sat)}-I_B$

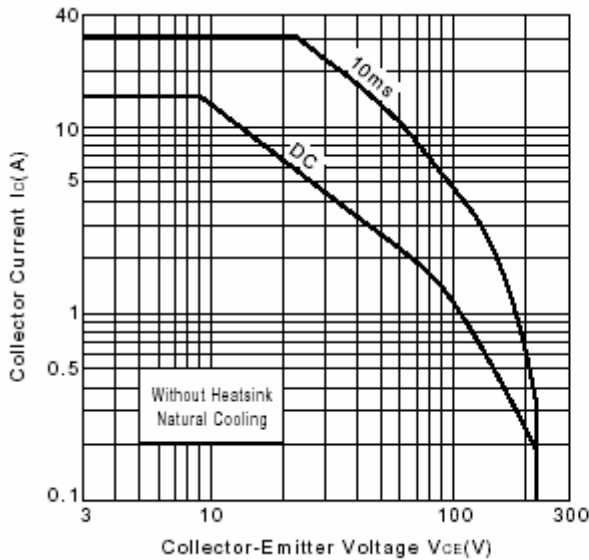

Fig.5 Safe Operating Area

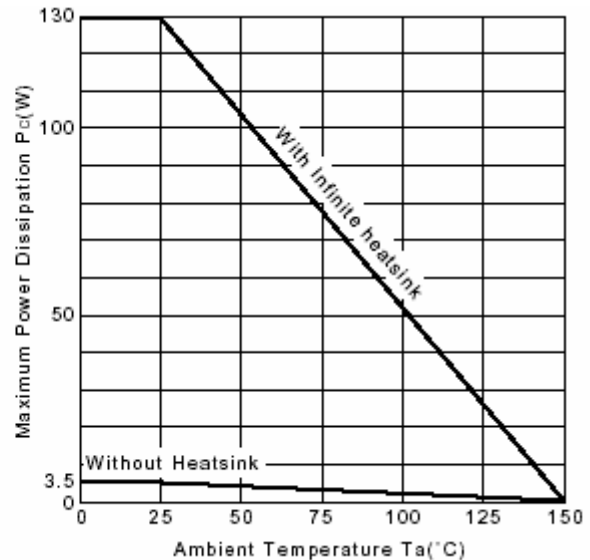

Fig.6 Power Derating

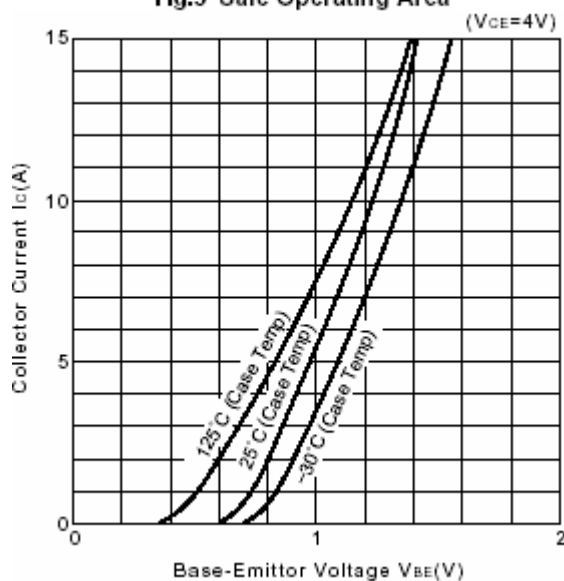

Fig.7  $I_C-V_{BE}$

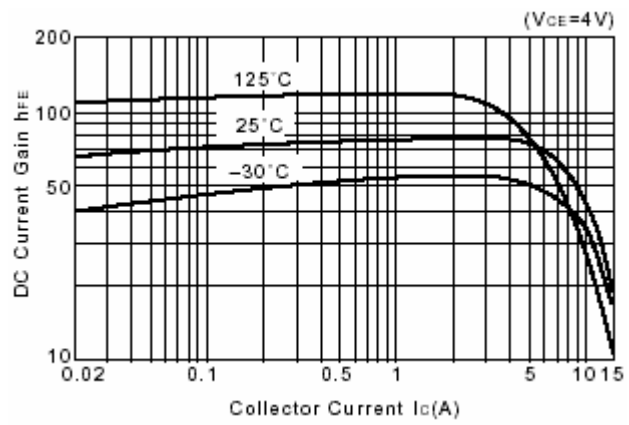

Fig.8 DC current Gain