

## PR-18 series

### Characteristic

PR-18 single turn potentiometers are enclosed in a metal housing, with carbon resistive element. Potentiometers have a linear characteristic of regulation, and are made in one of three versions, which differ in the type of terminals, for PCB and wire soldering. PR-18 series potentiometers may be equipped in a single-pole switch. Potentiometers with 5% and 10% resistance tolerance are available on request.

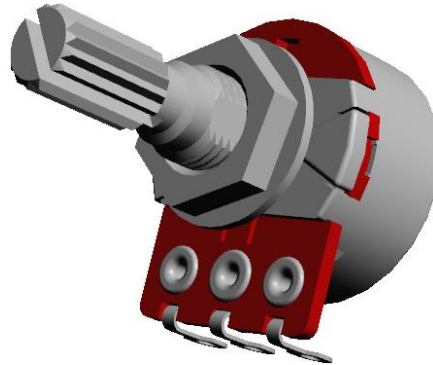

<u>Parameter</u>		<u>Value</u>
Nominal resistance		E3 series
Range of available resistances		120 Ω ... 4,7 MΩ
Resistance tolerance	$R \leq 220 \text{ k}\Omega$	$\pm 20\%$
	$R > 220 \text{ k}\Omega$	$\pm 30\%$
Max. dissipation power $P_n$ ( $T = 40^\circ\text{C}$ )		0,2 W
Max. load at category temperature		25% $P_n$
Max. operating voltage		200 V
Breakdown voltage		280 V
Mechanical rotation angle		$300^\circ \pm 5^\circ$
Switch parameters	AC	120 V / 1 A
	DC	16 V / 1 A
Climatic category		25/070/10

### Shaft types

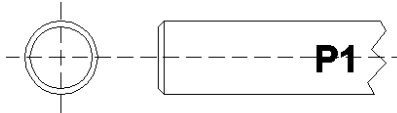
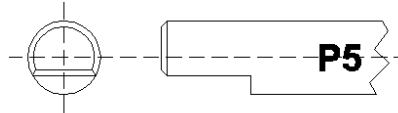
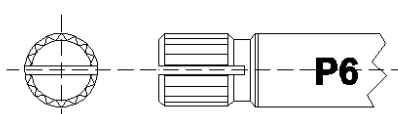
Type	Length L [mm]	
P1	16; 20; 25; 32	
P5	16; 20; 25; 32	
P6	16; 20; 25; 32	

### TELPOD S.A.

str. Pilsudskiego 63A  
32-050 Skawina  
[www.telpod.pl](http://www.telpod.pl)

Technical division: +48 (0)12 257 10 12  
Sales division: +48 (0)12 257 10 35  
fax: +48 (0)12 257 10 13  
e-mail: [potentiometer@telpod.pl](mailto:potentiometer@telpod.pl)

date: 04 / 2015  
Copyright 2015 by Telpod

## PR-18 series

### Dimensions

PR ... // version with ring terminals for wire soldering

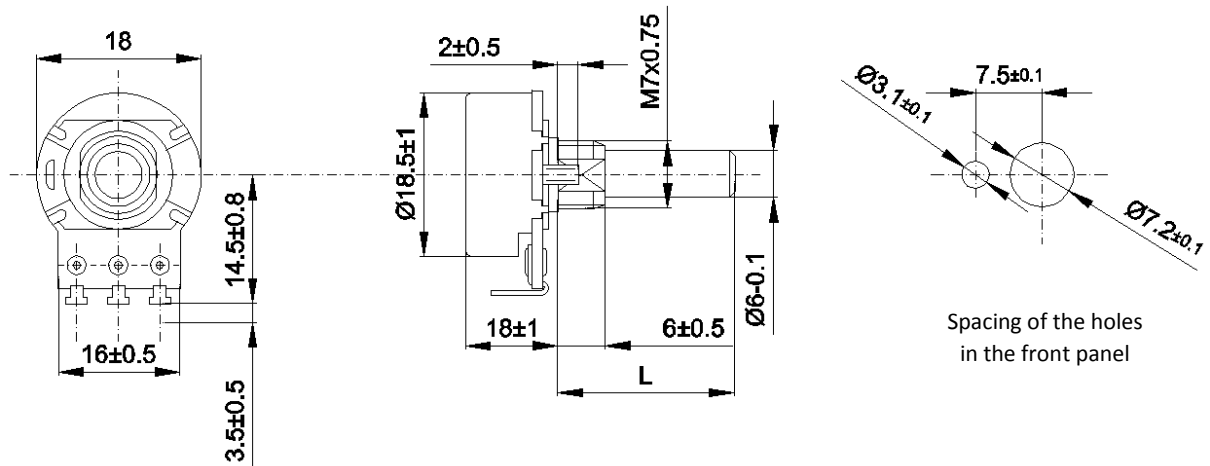

PRPC ... // version with terminals for PCB bent toward the shaft

PRP... // version with straight terminals for PCB

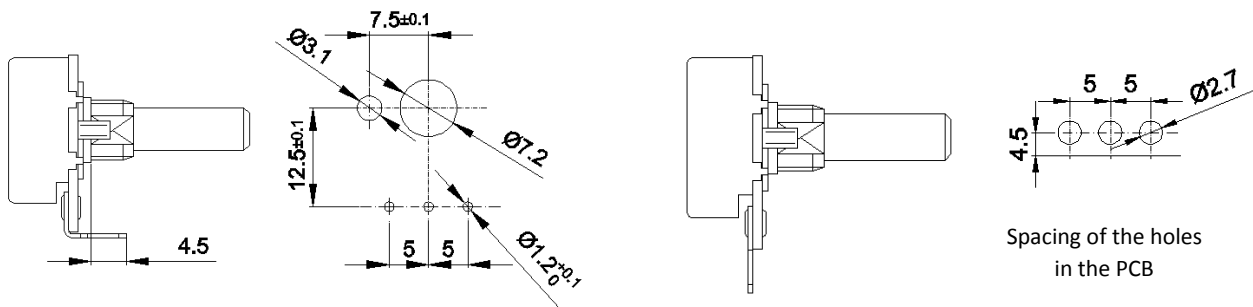

PR ... s56 // potentiometer with a single-pole switch

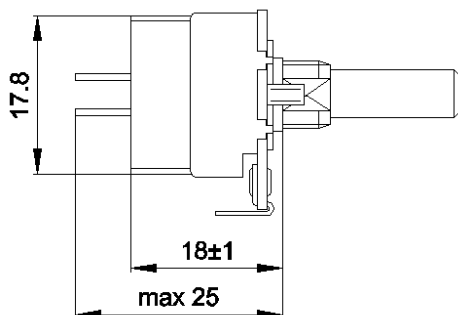

### TELPOD S.A.

str. Pilsudskiego 63A  
32-050 Skawina  
[www.telpod.pl](http://www.telpod.pl)

Technical division: +48 (0)12 257 10 12  
Sales division: +48 (0)12 257 10 35  
fax: +48 (0)12 257 10 13  
e-mail: [potentiometer@telpod.pl](mailto:potentiometer@telpod.pl)

date: 04 / 2015  
Copyright 2015 by Telpod