



**Opto Plus LED Corp.**  
**0.56" Case Mold Type LED Display**  
**OPD-D5630SR | OPD-D5631SR**

● **EDIT HISTORY**

Version A: Nov. 04, 2020

Preliminary Spec.



# Opto Plus LED Corp.

## 0.56" Case Mold Type LED Display

### OPD-D5630SR | OPD-D5631SR

#### ● FEATURES

- 0.56 inch (14.2 mm) Digit Height.
- Low current operation.
- Case mold type.
- RoHS compliant, Pb Free.

#### ● DESCRIPTION

The device are 0.56 inch (14.2 mm) height dual digit 7-segment displays.

The device is Opto Plus LED Corp standard LED Display.

This device utilizes Super Red LED chip which are made from AlGaAs on a transparent GaAs,SH substrate.

The device has face and segment option, please refer to **PRODUCT APPEARANCE**.

#### ● DEVICE

	PART NO.	DESCRIPTION
	OPD-D5630SR-GW	Common Anode   Gray face   White segment
	OPD-D5631SR-GW	Common Cathode   Gray face   White segment
	OPD-D5630SR-BW	Common Anode   Black face   White segment
	OPD-D5631SR-BW	Common Cathode   Black face   White segment

#### RoHS Compliance



#### Pb Free.





# Opto Plus LED Corp.

## 0.56" Case Mold Type LED Display

### OPD-D5630SR | OPD-D5631SR

#### MECHANICAL DIMENSIONS

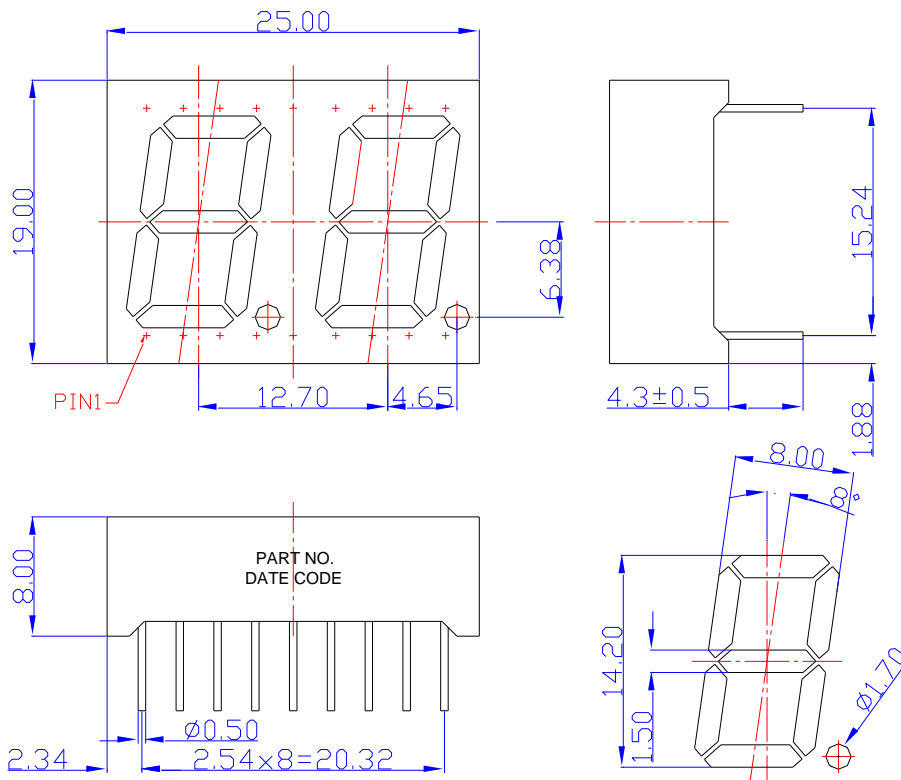

NOTES: Dimension is in millimeters. Tolerance is  $\pm 0.25$  mm unless otherwise noted.

#### TYPICAL INTERNAL EQUIVALENT CIRCUIT

Turn On Color

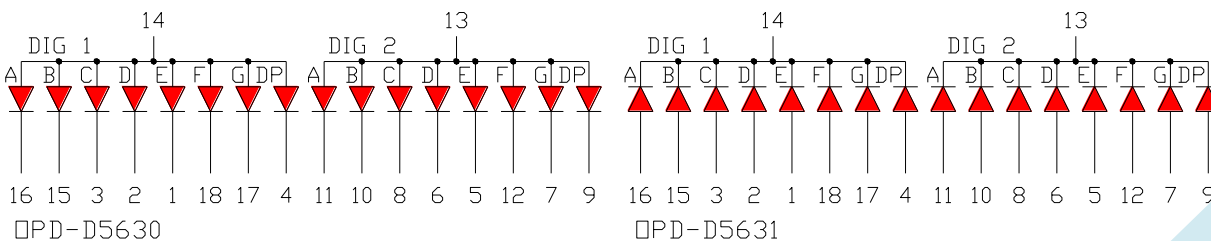
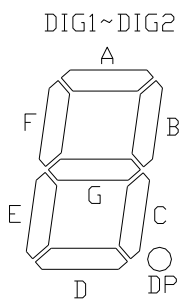
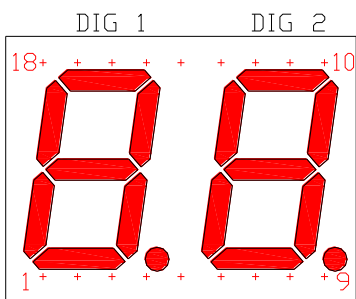

※EMITTED COLOR : SUPER RED



# Opto Plus LED Corp.

## 0.56" Case Mold Type LED Display

### OPD-D5630SR | OPD-D5631SR

#### ● SR: SUPER RED (AlGaAs/GaAs, SH)

ABSOLUTE MAXIMUM RATING AT Ta=25°C

Parameter	Symbol	Maximum Rating	Unit
Power dissipation	P <sub>AD</sub>	48	mW
Continuous forward current	I <sub>AF</sub>	20	mA
Peak current (duty cycle 1/10, 1kHz)	I <sub>PF</sub>	40	mA
Reverse voltage	V <sub>R</sub>	5	V
Operating temperature	T <sub>OPR</sub>	-40 to +85	°C
Storage temperature	T <sub>STG</sub>	-40 to +85	°C

ELECTRICAL - OPTICAL CHARACTERISTICS AT Ta=25°C

Characteristic	Symbol	Condition	Min.	Type.	Max.	Unit
Forward Voltage	V <sub>F</sub>	I <sub>F</sub> = 20mA	-	1.8	2.2	V
Reverse Current	I <sub>R</sub>	V <sub>R</sub> = 5V	-	-	10	μA
Peak Wavelength	λ <sub>P</sub>	I <sub>F</sub> = 20mA	-	655	-	nm
Dominant Wavelength	λ <sub>D</sub>	I <sub>F</sub> = 20mA	-	644	-	nm
Luminous Intensity	I <sub>V</sub>	I <sub>F</sub> = 20mA	-	10	-	mcd
Spectral Line Half-Bandwidth	Δλ	I <sub>F</sub> = 20mA	-	20	-	nm



# Opto Plus LED Corp.

## 0.56" Case Mold Type LED Display

### OPD-D5630SR | OPD-D5631SR

#### ● PRODUCT APPEARANCE

The most common reflector color and segment color are show in below diagram.

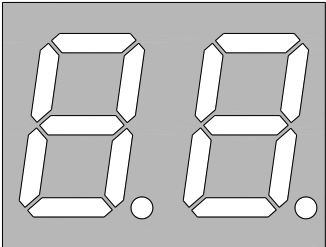
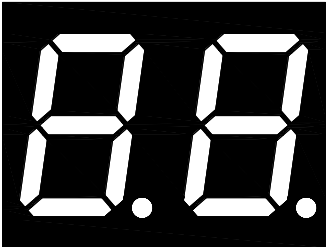
-GW	-BW
	
※ REFLECTOR COLOR: Gray ※ SEGMENT COLOR: White	※ REFLECTOR COLOR: Black ※ SEGMENT COLOR: White

Opto Plus can customize reflector and segment colors by customer's request. If you have these request please visit [www.opledtw.com](http://www.opledtw.com) or contact [sales@opledtw.com](mailto:sales@opledtw.com) for more **Standard Product Customization** information.

Part NO. related to reflector and segment colors show as table below.

PART NO.	DESCRIPTION
OPD-D5630SR-GW	Common Anode   Gray face   White segment
OPD-D5631SR-GW	Common Cathode   Gray face   White segment
OPD-D5630SR-BW	Common Anode   Black face   White segment
OPD-D5631SR-BW	Common Cathode   Black face   White segment

#### ● SR: SUPER RED (AlGaAs/GaAs,SH) CURVE

Typical Electro-optical Characteristic Curves  
(25 °C Free Air Temperature Unless Otherwise Specified)

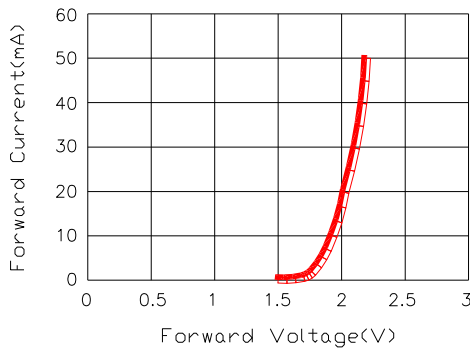

Fig.1 FORWARD CURRENT VS. FORWARD VOLTAGE

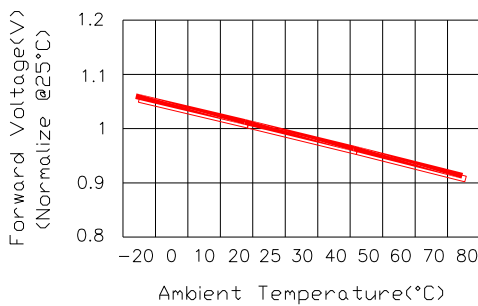
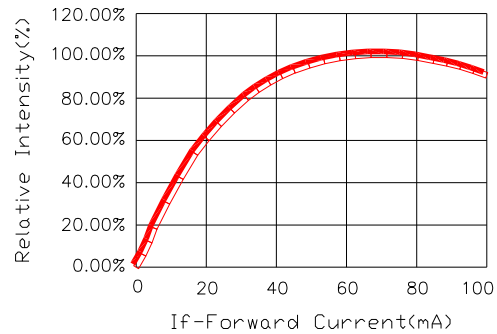

Fig.3 FORWARD VOLTAGE VS. TEMPERATURE

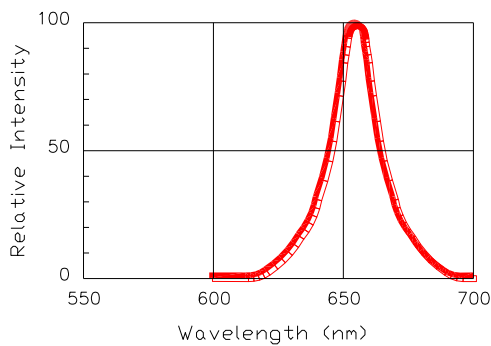
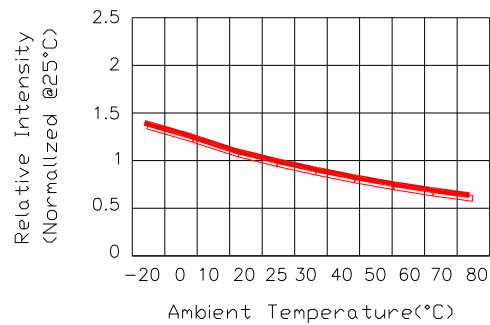

Fig.5 RELATIVE INTENSITY VS. WAVELENGTH

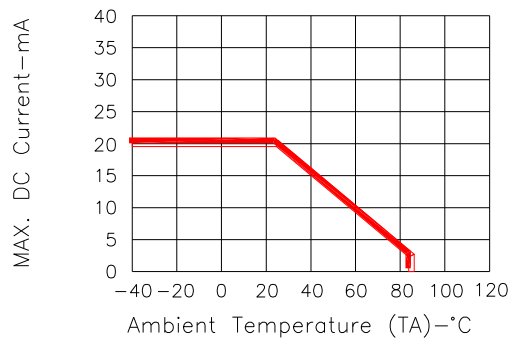
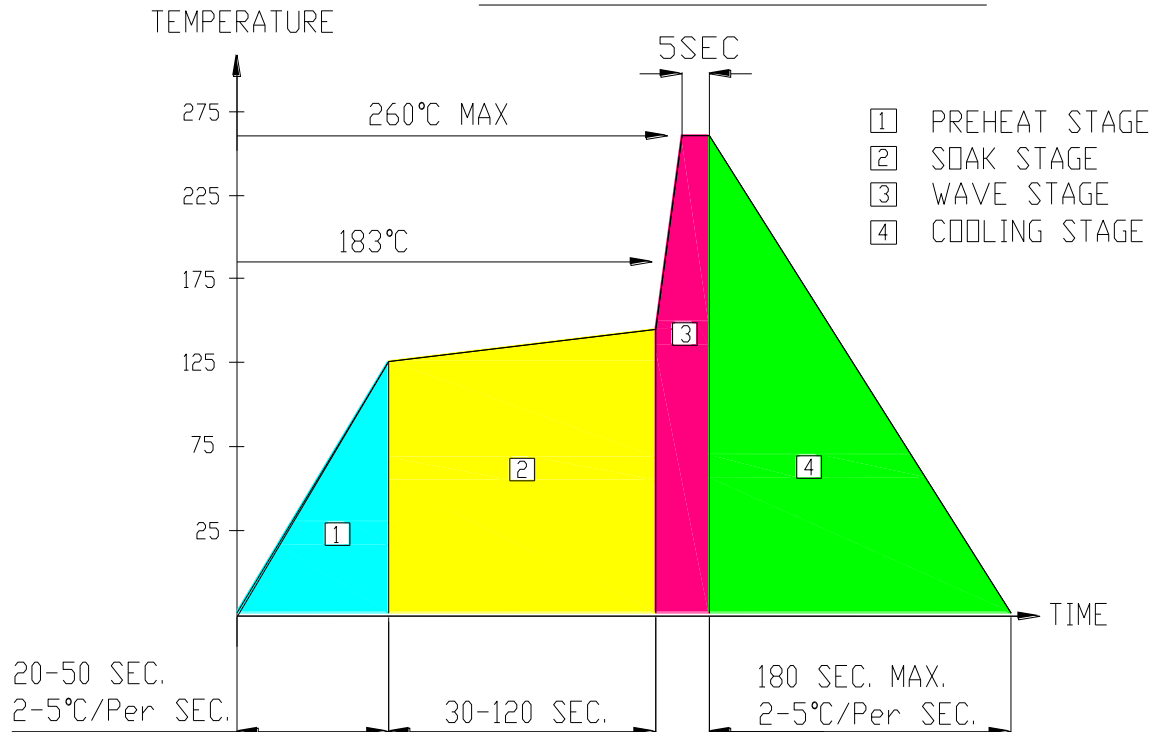

Fig.6 MAX. ALLOWABLE DC CURRENT VS. AMBIENT TEMPERATURE

## ● RECOMMEND SOLDERING PROFILE

### WAVE SOLDER PROFILE



## ● Note:

- Recommend pre-heat temperature of 105°C or less (as measured with a thermocouple attached to the LED pins) prior to immersion in the solder wave with a maximum solder bath temperature of 260°C
- Peak wave soldering temperature between 245°C ~ 225°C for 3 sec (5 sec max)
- No more than one wave soldering pass

## ● SOLDERING IRON

Basic spec is  $\leq 4$  sec when 260°C. If temperature is higher, time should be shorter (+10°C → 1 sec). Power dissipation of Iron should be smaller than 15W, and temperature should be controllable. Surface temperature of the device should be under 230°C.

## ● REWORK

Customer must finish rework within  $\leq 3$  sec under 350°C.  
The head of soldering iron cannot touch copper foil.