

FERRITE MATERIAL: K5B(RMS-303)									
PART NUMBER	A	B	C	IMPEDANCE (Ω)		STANDARD PACK			
				25MHz	100MHz				
				RT-30-10-20	3.00		2.00	1.00	20
RT-30-12-20			1.20	17	38				
RT-35-8-25		3.00	1	25	52				
RT-35-8-30			0.80	31	53				
RT-35-10-30			1.00	29	50				
RT-35-12-30			1.20	25	45				
RT-35-13-30		3.25	1.30	26	47				
RT-35-13-33			27	48					
RT-35-14-30		3.50	3.00	1.40	22	500			
RT-35-14-33			26	49					
RT-35-15-15			1.54	1.50	15		36		
RT-35-15-30			3.00	1.50	21		42		
RT-35-15-33			3.30	1.50	21		43		
RT-35-17-30			3.00	1.70	17		38		
RT-35-18-13			1.30	1.80	11		31		
RT-35-18-30			3.00		18		37		
RT-39-23-25	3.94		2.54	2.29	15		36	2000	
RT-40-15-20	4.00		2.00	1.50	19		39		
RT-40-15-30		3.00	23		45				
RT-40-20-15		1.50	2.00	13	35				
RT-40-20-20		2.00		14	37				
RT-40-20-30		3.00		20	41				
RT-40-22-17		1.70		2.20	12	31			
RT-41-16-40	4.10	4.00	1.60	31	55	2000			
RT-43-28-25	4.30	2.50	2.80	13	35	4000			
RT-44-28-14	4.40	1.40		12	32	5000			
RT-45-25-32	4.50	3.20	2.50	18	37	4000			
RT-50-20-20	5.00	2.00	2.00	17	37	2000			
RT-50-20-40		4.00		30	46				
RT-50-23-30		3.00		2.30	19		39		
RT-60-30-15		1.50		3.00	10		31		
RT-60-30-20	2.00	15	35						
RT-60-30-30	3.00	21	40						
RT-60-30-38	3.80	22	43						
RT-60-30-40	4.00	24	44						
RT-60-30-55	5.50	31	51						
RT-65-43-60	6.50	6.00	4.30	21	42		1000		
RT-70-35-40	7.00	4.00	3.50	23	46				
RT-70-35-60		6.00		34	59				
RT-73-33-43	7.30	4.30	3.30	27	50				
RT-75-24-40	7.50	4.00	2.40	32	62				
RT-76-52-62	7.60	6.20	5.20	21	40	500			
RT-79-40-70	7.90	7.00	4.00	33	57				
RT-80-31-40	8.00	4.00	3.10	33	52				
RT-80-40-30		3.00	17	37	1000				
RT-80-40-40		4.00	4.00	23		46			
RT-80-40-60		6.00	33	57	500				
RT-80-60-50		5.00	6.00	15		36			

FERRITE MATERIAL K5B(RMS-303)							
PART NUMBER	A	B	C	IMPEDANCE (Ω)		STANDARD PACK	
				25MHz	100MHz		
				RT-80-60-70	8.00		7.00
RT-85-50-30	8.50	3.00	5.00	16	34	1000	
RT-90-50-30	9.00			37			
RT-90-50-80		8.00	5.00	38	64	500	
RT-93-45-64	9.30	6.35		4.50	32		50
RT-94-63-72	9.40	7.20	6.30	22	42	1000	
RT-95-46-46	9.50	4.57	4.60	27	47	500	
RT-95-48-33		3.30	4.80	22	45	1000	
RT-95-50-48		4.80	5.00	26	49	500	
RT-95-50-50		5.00		26	49		
RT-100-30-60	10.00	6.00	3.00	50	82		1000
RT-100-50-50		5.00	5.00	34	73		
RT-100-60-30		3.00	6.00	15	37	500	
RT-100-60-40		4.00		20	42		
RT-100-60-50		5.00		22	41		
RT-100-60-62		6.20		25	49		
RT-100-60-80		8.00	33	60	500		
RT-100-70-50		5.00	17	39			
RT-100-70-70		7.00	7.00	22	44		
RT-100-70-75		7.50	25	46	200		
RT-103-58-102	10.30	10.20	5.80	40			67
RT-110-50-90	11.00	9.00	5.00	60	107		500
RT-120-60-40	12.00	4.00	6.00	24	48		
RT-120-60-60		6.00		34	58		
RT-120-60-80		8.00		46	77		
RT-120-70-55		5.50		7.00	26	49	
RT-120-70-60	6.00	28	48	200			
RT-125-80-64	12.50	6.35	8.00		24	46	
RT-125-80-120		12.00		36	58		
RT-127-79-64	12.70	6.35	7.90	26	68	500	
RT-130-70-30	13.00	3.00	7.00	17	39		
RT-130-70-55		5.50		27	50	300	
RT-130-70-60		6.00		28	51	500	
RT-130-70-70		7.00		32	56	200	
RT-130-71-127	12.70	7.10	60	106			
RT-140-80-50	14.00	5.00	8.00	26	50	500	
RT-140-80-70		7.00		28	50		
RT-140-90-50		5.00		9.00	19		37
RT-142-64-102	14.20	10.16	6.35	57	95	200	
RT-142-64-135		13.50		75	125		
RT-142-80-120		12.00		8.00	49		76
RT-145-102-80	14.50	8.00	10.20	29	69	100	
RT-150-105-120	15.00	12.00	10.50	37	62		
RT-159-79-143	15.88	14.27	7.87	79	121		
RT-160-80-120	16.00	12.00	8.00	59	95		
RT-160-90-120		12.00	9.00	55	87	200	
RT-160-100-70		7.00	10.00	32	71	300	

REV.	MODIFICATION.	DATE	DRN
01	NEW DRAWING	19/06/06	NJB
02	CO2010196	24/04/08	SF
03	CO2010845	20/10/09	OW
04	CO2010989	01/10/10	SF
05	CO2011049	26/01/11	SF
06	CO2011144	17/05/11	SF
07	CO2011253	16/04/12	SF
08	CO2011277	31/07/12	SF

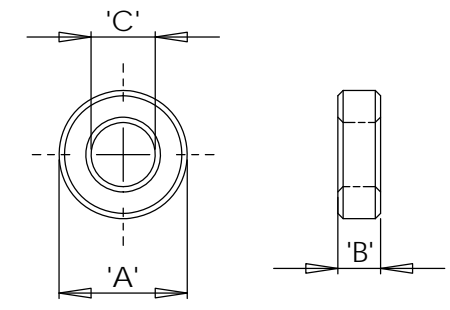

- NOTES.**
- 1) See drawings 06-073 sheets 3 of 12 to 12 for Impedance graphs.
 - 2) Impedance figures are typical values.
 - 3) Other sizes available by special order.
 - 4) Packaging information is only a guide & subject to variation.

INFORMATION CONTAINED IN THIS DOCUMENT IS CONFIDENTIAL TO RICHCO INTERNATIONAL Co. Ltd. AND MAY NOT BE DISCLOSED OR REPRODUCED IN WHOLE OR PART WITHOUT THEIR WRITTEN CONSENT.

RICHCO, INC.
WWW.RICHCO-INC.COM

ALL DIMENSIONS IN MM
GENERAL TOLERANCES ±0.25
UNLESS OTHERWISE STATED
1 DECIMAL PLACE ±
2 DECIMAL PLACES ±
ANGULAR ±1°

THIRD ANGLE

MATERIAL: See Table COLOUR:

DESCRIPTION: RT Toroid Cores. PART No: See Table

DRG No: 06-073 NPR No: Mass:(g) SHEET SIZE A3

DRN NJB DATE 19/06/06 CHKD AS DATE 19/06/06 SCALE NTS SHEET No. 1 OF 12

FERRITE MATERIAL: K5B(RMS-303)						
PART NUMBER	A	B	IMPEDANCE (Ω)		STANDARD PACK	
			25MHz	100MHz		
RT-160-100-80	16.00	8.00	29	55	200	
RT-160-100-100		10.00	43	85	150	
RT-160-120-80		8.00	12.00	26	48	200
RT-160-120-150	15.00	33		58		
RT-165-82-130	16.50	13.00	70	125	120	
RT-165-82-160		16.00	83	140		
RT-165-92-75		7.50	9.2	35	70	200
RT-175-80-100	17.50	10.00	62	94	98	
RT-175-95-50		5.00	10.00	22	44	200
RT-175-95-64		6.00	9.50	31	53	
RT-175-95-70		7.00		30	54	
RT-175-95-110		11.00		55	96	
RT-175-95-127		13.00		59	95	
RT-175-95-135		14.00		63	115	112
RT-175-95-150		15.00		70	113	
RT-175-107-80		8.00	10.70	33	60	200
RT-180-100-60		6.00	10.00	31	55	
RT-180-100-100	18.00	10.00		47	77	
RT-180-100-150	15.00	10.16	69	123	100	
RT-187-102-143	18.67		14.27	70		119
RT-187-102-170	17.02		17.02	75		125
RT-190-100-100	10.00	10.00	54	102	200	
RT-190-120-80	19.00	8.00	32	72		
RT-190-120-100	10.00	12.00	37	78	100	
RT-200-100-50	20.00	5.00	28	68	140	
RT-200-100-80		8.00	10.00	38	62	100
RT-200-100-100		10.00	12.00	50	82	
RT-200-120-100	10.00	12.00	40	68	84	
RT-205-102-100	20.50	10.20	53	86	80	
RT-212-127-60	21.20	6.00	27	52	200	
RT-220-135-64	22.00	6.35	28	53		
RT-220-135-80		8.00	13.50	37	78	100
RT-220-140-65		7.00	14.00	28	68	84
RT-220-140-80		8.00		33	73	100
RT-220-140-100		10.00		42	90	84
RT-220-140-120		12.00		40	85	
RT-221-137-127		22.10	12.70	48	83	100
RT-225-138-64		22.50	6.40	25	47	200
RT-225-138-127	12.70		13.80	46	71	50
RT-230-135-64	23.00	6.35	28	53	200	
RT-236-114-140	23.60	14.00	80	133	60	
RT-236-150-60		6.00	11.40	26	70	72
RT-236-150-114		11.00		43	85	100
RT-250-150-80	25.00	8.00	38	79		
RT-250-150-100		10.00	44	87	50	
RT-250-150-120		12.00	53	97	60	
RT-250-150-150		15.00	61	105		
RT-254-127-64	25.40	6.35	39	80	100	
RT-259-128-213	25.91	21.30	106	174	40	
RT-260-130-127	26.00	12.70	74	125	50	

FERRITE MATERIAL: K5B(RMS-303)						
PART NUMBER	B	A	C	IMPEDANCE (Ω)		STANDARD PACK
				25MHz	100MHz	
RT-280-160-75	28.00	7.50	16.00	33	59	100
RT-280-160-130		13.00		55	100	50
RT-280-160-170		17.00		71	120	
RT-280-160-200	20.00	20.00	85	155	40	
RT-290-190-75	29.00	7.50	19.00	26	70	100
RT-290-190-77		7.70		33	76	50
RT-290-190-138		13.80		46	94	40
RT-310-190-70	31.00	7.00	19.00	35	77	
RT-310-190-80		8.00	30	55		
RT-310-190-160		16.00	68	115		
RT-310-190-222	22.00	88	146	32		
RT-360-250-70	36.00	7.00	25.00	23	63	36
RT-360-250-127		13.00		39	84	24
RT-406-274-150	40.60	15.00	27.40	55	106	18
RT-594-348-128	59.40	12.80	34.80	58	118	10

REV.	MODIFICATION.	DATE	DRN
01	NEW DRAWING	19/06/06	NJB
02	CO2010196	24/04/08	SF
03	CO2010845	20/10/09	OW
04	CO2010989	01/10/10	SF
05	CO2011049	26/01/11	SF
06	CO2011144	17/05/11	SF
07	CO2011253	16/04/12	SF
08	CO2011277	31/07/12	SF

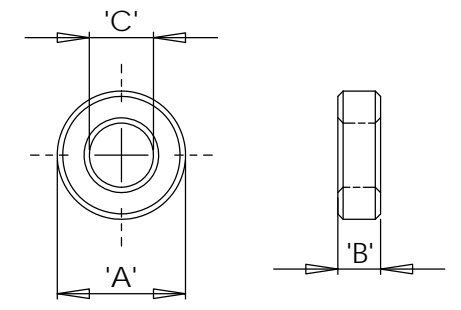

- NOTES.
- 1) See drawings 06-073 sheets 3 of 12 to 12 for Impedance graphs.
 - 2) Impedance figures are typical values.
 - 3) Other sizes available by special order.
 - 4) Packaging information is only a guide & subject to variation.

INFORMATION CONTAINED IN THIS DOCUMENT IS CONFIDENTIAL TO RICHCO INTERNATIONAL Co. Ltd. AND MAY NOT BE DISCLOSED OR REPRODUCED IN WHOLE OR PART WITHOUT THEIR WRITTEN CONSENT.

RICHCO, INC.
WWW.RICHCO-INC.COM

ALL DIMENSIONS IN MM
GENERAL TOLERANCES ±0.25
UNLESS OTHERWISE STATED
1 DECIMAL PLACE ±
2 DECIMAL PLACES ±
ANGULAR ±1°

THIRD ANGLE

MATERIAL: See Table COLOUR:

DESCRIPTION: RT Toroid Cores. PART No: See Table

DRG No: 06-073 NPR No: Mass:(g) SHEET SIZE A3

DRN DATE CHKD DATE SCALE SHEET No.
NJB 19/06/06 AS 19/06/06 NTS 2 OF 12

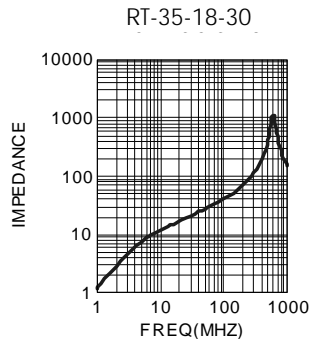
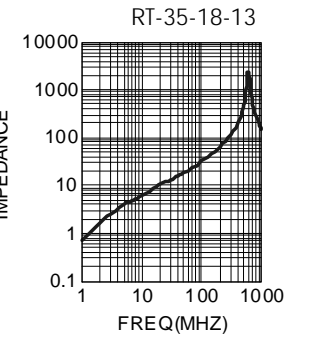
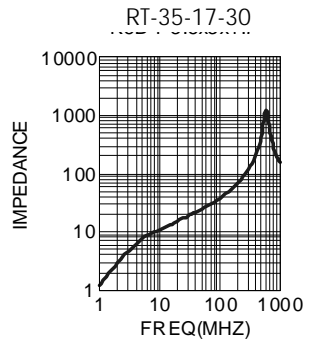
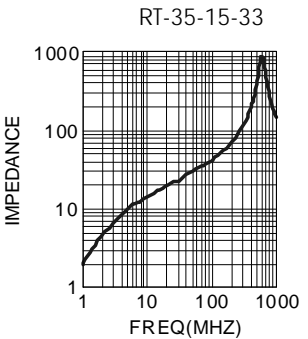
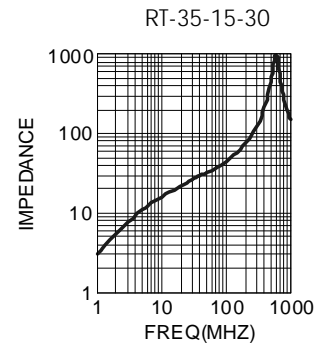
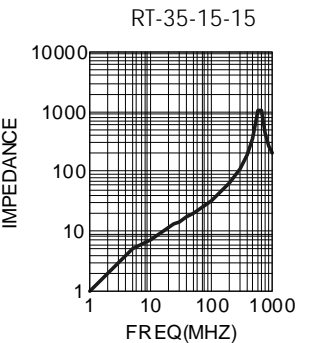
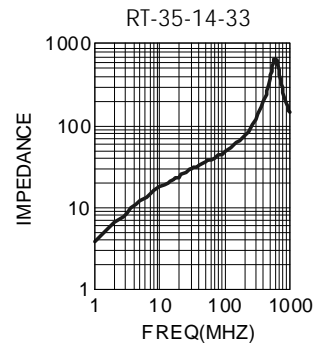
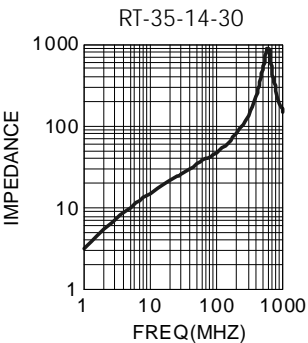
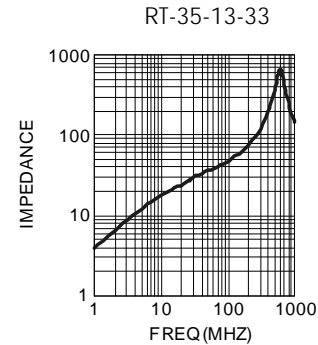
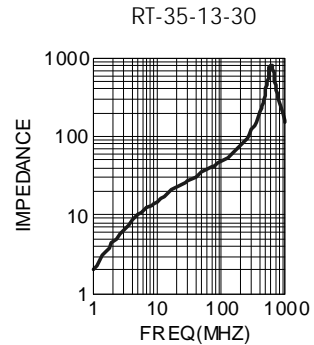
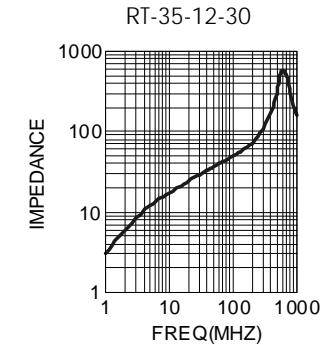
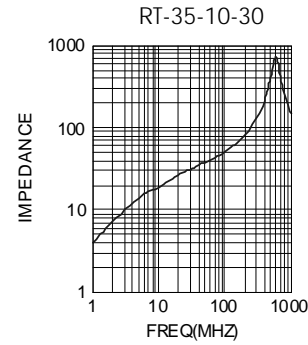
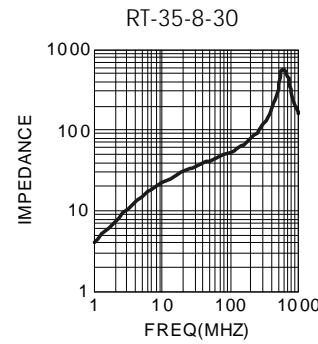
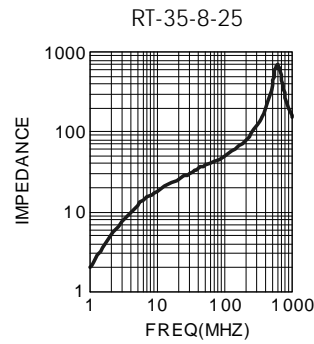
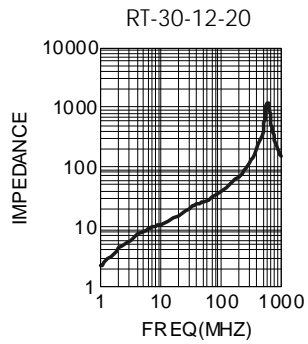
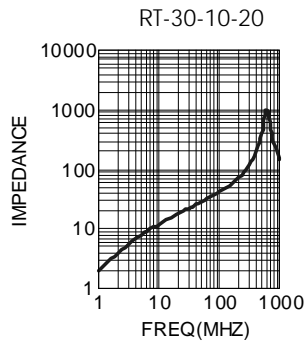

REV.	MODIFICATION.	DATE	DRN
01	NEW DRAWING	19/06/06	NJB
02	CO2010196	24/04/08	SF
03	CO2010845	20/10/09	OW
04	CO2010989	01/10/10	SF
05	CO2011049	26/01/11	SF
06	CO2011144	17/05/11	SF
07	CO2011253	16/04/12	SF
08	CO2011277	31/07/12	SF

NOTES.
1) Impedance figures are typical values.

INFORMATION CONTAINED IN THIS DOCUMENT IS CONFIDENTIAL TO RICHCO INTERNATIONAL Co. Ltd. AND MAY NOT BE DISCLOSED OR REPRODUCED IN WHOLE OR PART WITHOUT THEIR WRITTEN CONSENT.

RICHCO, INC.
WWW.RICHCO-INC.COM

DESCRIPTION:
RT Toroid Cores, Impedance Graphs.

DRG No: 06-073		SHEET SIZE A3	
DRN NJB	DATE 30/05/06	CHKD AS	DATE 30/05/06
SCALE NTS		SHEET No. 3 OF 12	

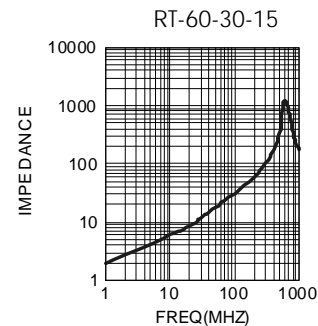
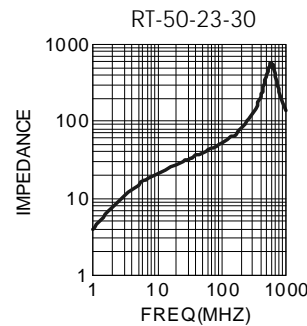
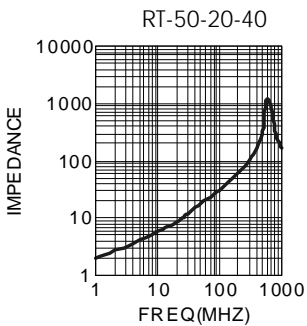
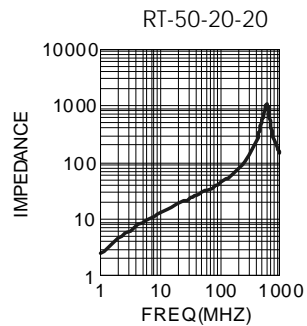
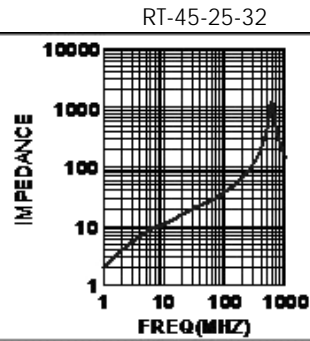
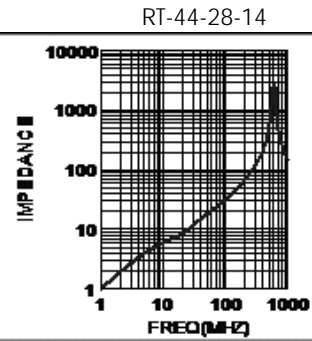
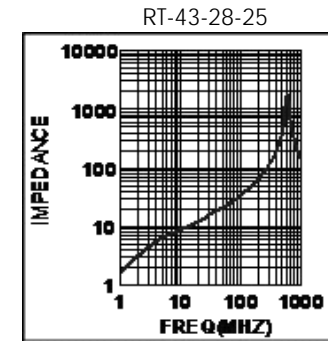
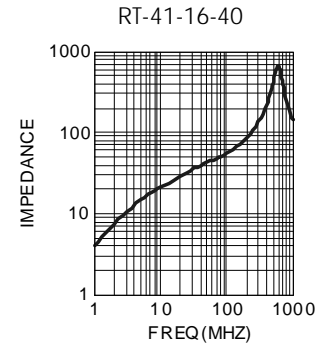
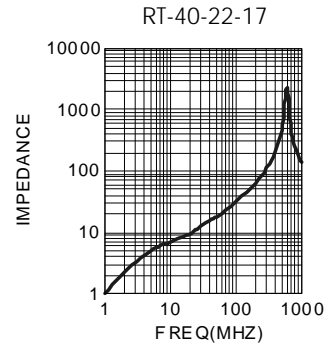
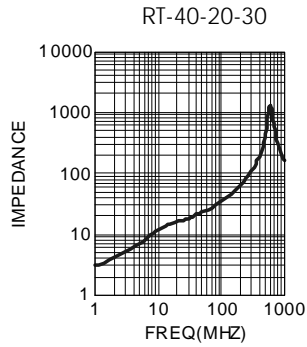
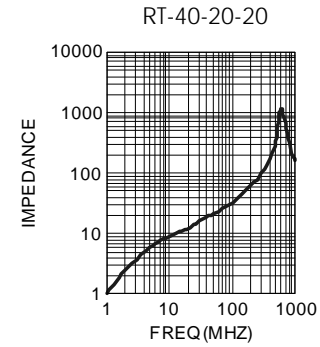
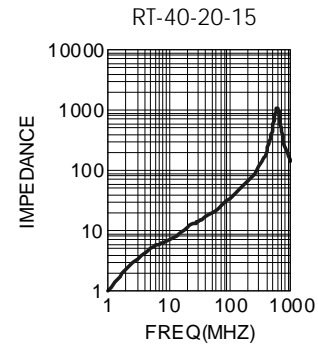
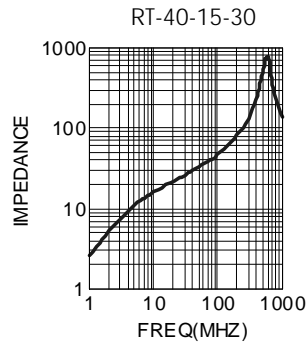
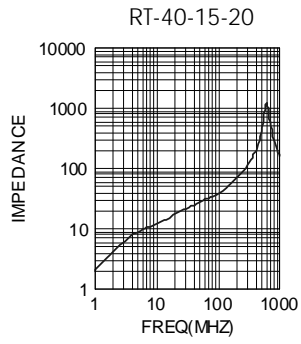
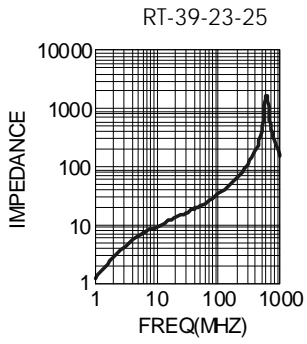

REV.	MODIFICATION.	DATE	DRN
01	NEW DRAWING	19/06/06	NJB
02	CO2010196	24/04/08	SF
03	CO2010845	20/10/09	OW
04	CO2010989	01/10/10	SF
05	CO2011049	26/01/11	SF
06	CO2011144	17/05/11	SF
07	CO2011253	16/04/12	SF
08	CO2011277	31/07/12	SF

NOTES.
1) Impedance figures are typical values.

INFORMATION CONTAINED IN THIS DOCUMENT IS CONFIDENTIAL TO RICHCO INTERNATIONAL Co. Ltd. AND MAY NOT BE DISCLOSED OR REPRODUCED IN WHOLE OR PART WITHOUT THEIR WRITTEN CONSENT.

RICHCO, INC.
WWW.RICHCO-INC.COM

DESCRIPTION:
RT Toroid Cores, Impedance Graphs.

DRG No: 06-073		SHEET SIZE A3	
DRN NJB	DATE 30/05/06	CHKD AS	DATE 30/05/06
SCALE NTS		SHEET No. 4 OF 12	

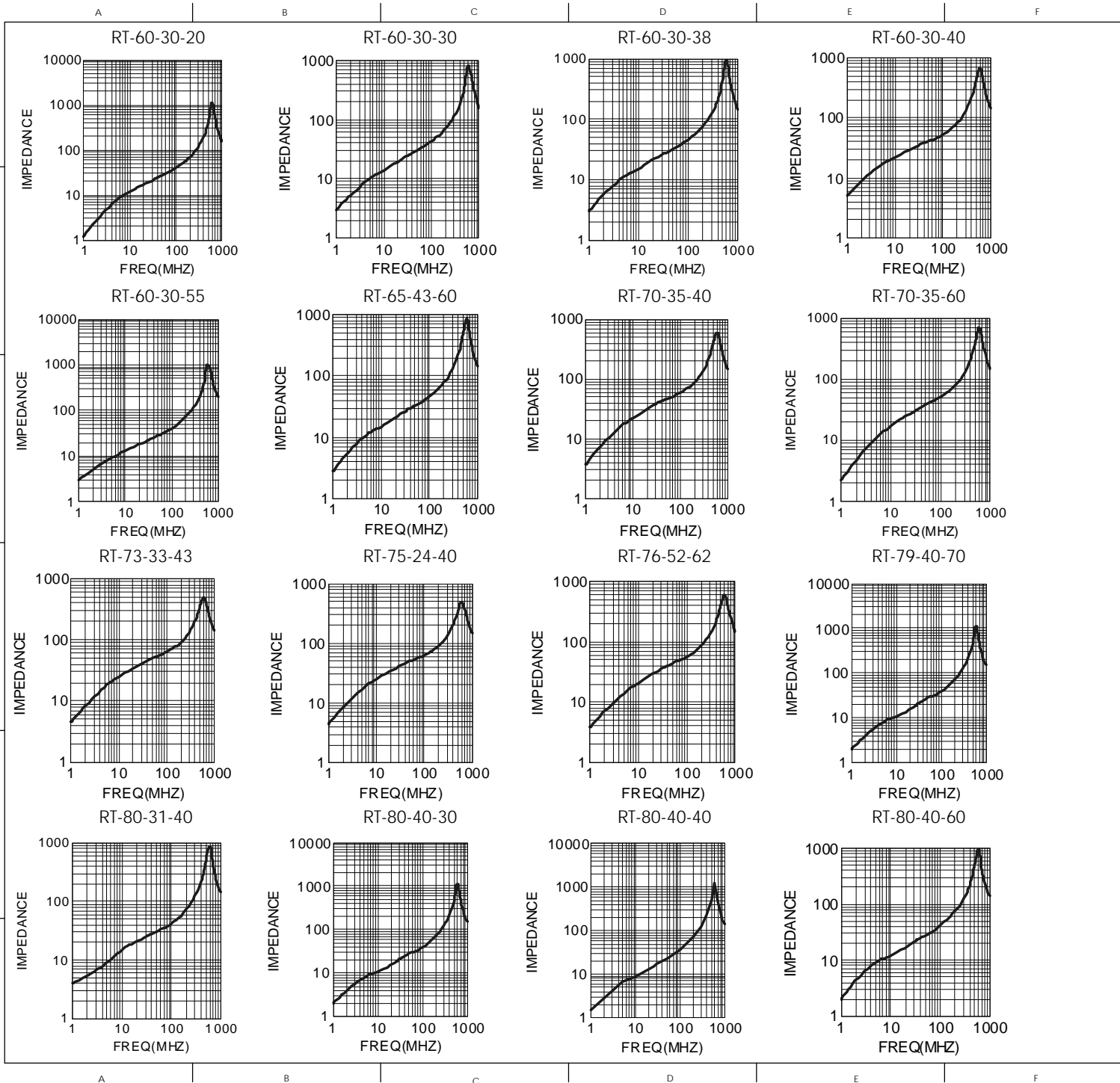

REV.	MODIFICATION.	DATE	DRN
01	NEW DRAWING	19/06/06	NJB
02	CO2010196	24/04/08	SF
03	CO2010845	20/10/09	OW
04	CO2010989	01/10/10	SF
05	CO2011049	26/01/11	SF
06	CO2011144	17/05/11	SF
07	CO2011253	16/04/12	SF
08	CO2011277	31/07/12	SF

NOTES.
 1) Impedance figures are typical values.

INFORMATION CONTAINED IN THIS DOCUMENT IS CONFIDENTIAL TO RICHCO INTERNATIONAL Co. Ltd. AND MAY NOT BE DISCLOSED OR REPRODUCED IN WHOLE OR PART WITHOUT THEIR WRITTEN CONSENT.

RICHCO, INC.
 WWW.RICHCO-INC.COM

DESCRIPTION:
 RT Toroid Cores, Impedance Graphs.

DRG No: 06-073		SHEET SIZE A3	
DRN NJB	DATE 30/05/06	CHKD AS	DATE 30/05/06
SCALE NTS		SHEET No. 5 OF 12	

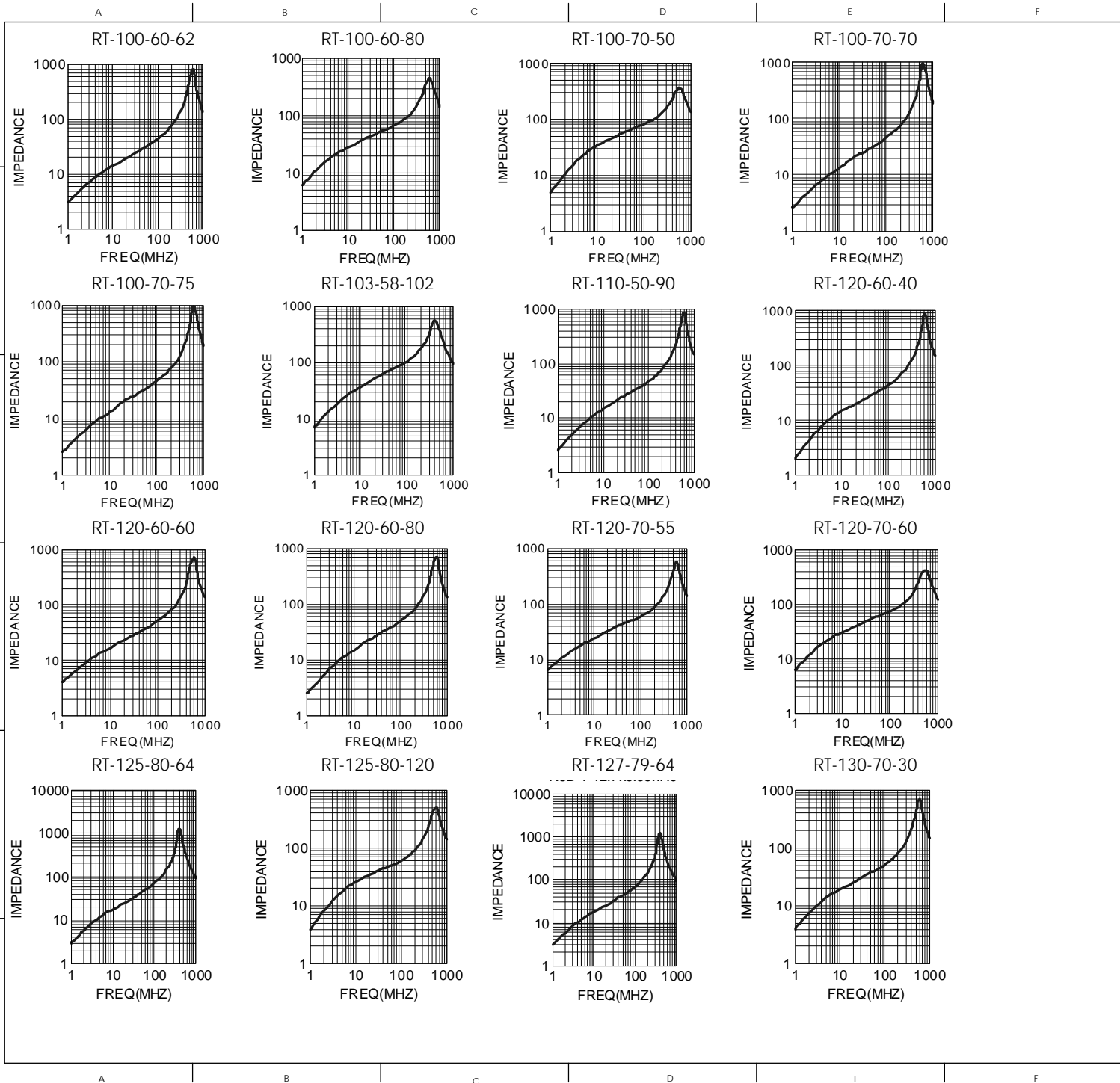

REV.	MODIFICATION.	DATE	DRN
01	NEW DRAWING	19/06/06	NJB
02	CO2010196	24/04/08	SF
03	CO2010845	20/10/09	OW
04	CO2010989	01/10/10	SF
05	CO2011049	26/01/11	SF
06	CO2011144	17/05/11	SF
07	CO2011253	16/04/12	SF
08	CO2011277	31/07/12	SF

NOTES.
 1) Impedance figures are typical values.

INFORMATION CONTAINED IN THIS DOCUMENT IS CONFIDENTIAL TO RICHCO INTERNATIONAL Co. Ltd. AND MAY NOT BE DISCLOSED OR REPRODUCED IN WHOLE OR PART WITHOUT THEIR WRITTEN CONSENT.

RICHCO, INC.
 WWW.RICHCO-INC.COM

DESCRIPTION:
RT Toroid Cores, Impedance Graphs.

DRG No: 06-073		SHEET SIZE A3	
DRN NJB	DATE 30/05/06	CHKD AS	SCALE NTS
DATE 30/05/06		SHEET No. 6 OF 12	

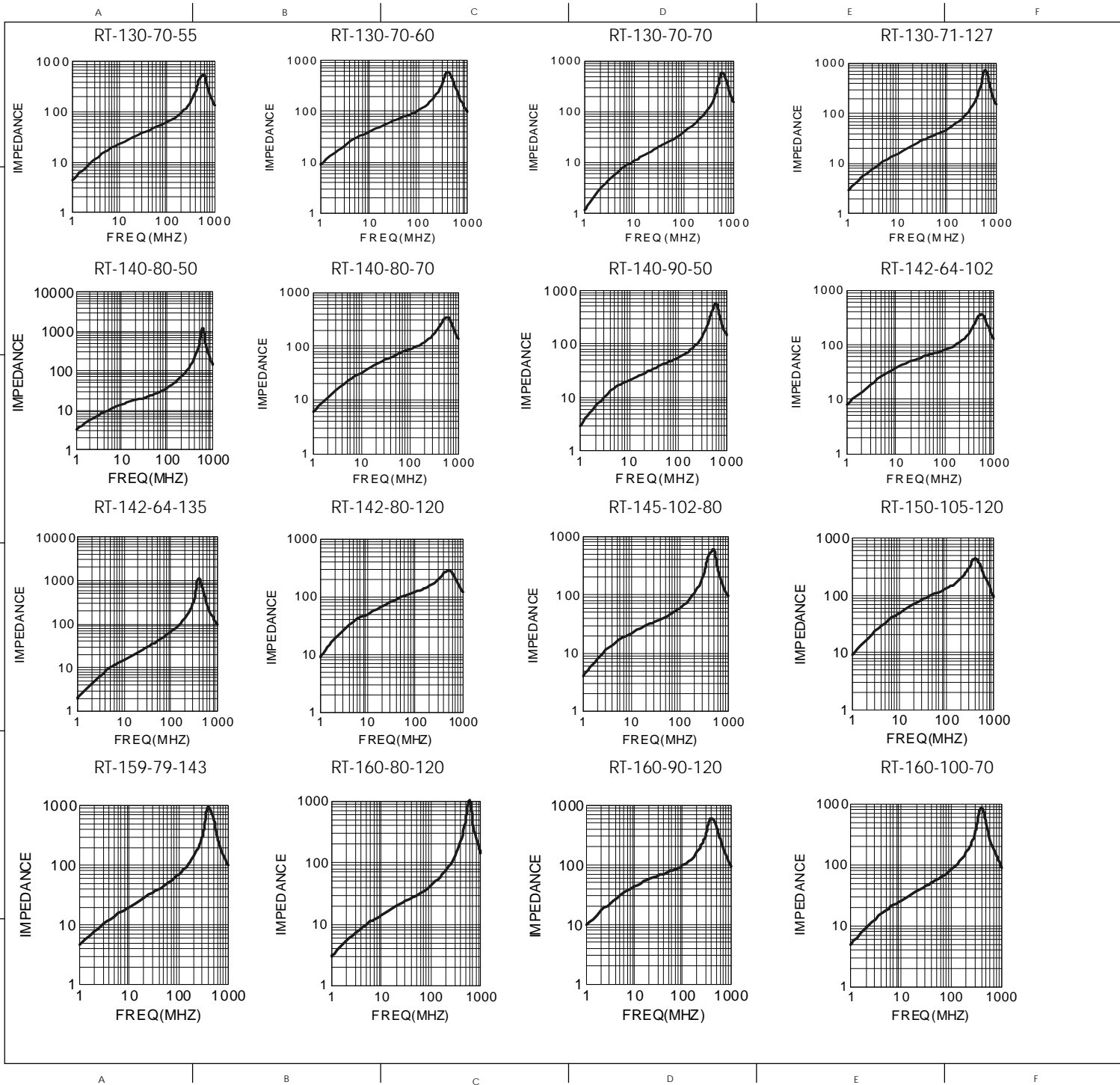

REV.	MODIFICATION.	DATE	DRN
01	NEW DRAWING	19/06/06	NJB
02	CO2010196	24/04/08	SF
03	CO2010845	20/10/09	OW
04	CO2010989	01/10/10	SF
05	CO2011049	26/01/11	SF
06	CO2011144	17/05/11	SF
07	CO2011253	16/04/12	SF
08	CO2011277	31/07/12	SF

NOTES.
 1) Impedance figures are typical values.

INFORMATION CONTAINED IN THIS DOCUMENT IS CONFIDENTIAL TO RICHCO INTERNATIONAL Co. Ltd. AND MAY NOT BE DISCLOSED OR REPRODUCED IN WHOLE OR PART WITHOUT THEIR WRITTEN CONSENT.

RICHCO, INC.
 WWW.RICHCO-INC.COM

DESCRIPTION:
RT Toroid Cores, Impedance Graphs.

DRG No: 06-073		SHEET SIZE A3	
DRN NJB	DATE 30/05/06	CHKD AS	SCALE NTS
DATE 30/05/06		SHEET No. 7 OF 12	

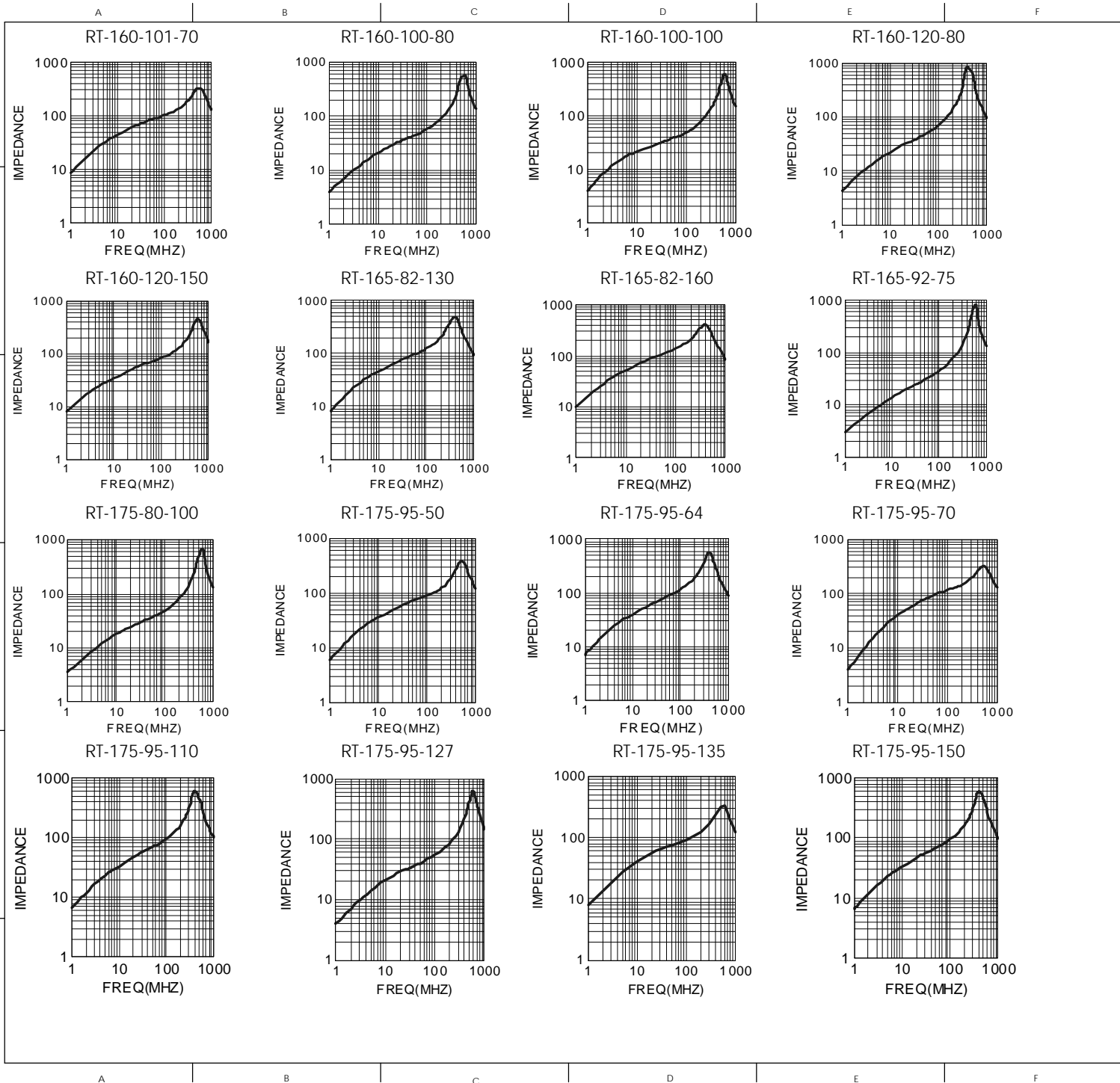

REV.	MODIFICATION.	DATE	DRN
01	NEW DRAWING	19/06/06	NJB
02	CO2010196	24/04/08	SF
03	CO2010845	20/10/09	OW
04	CO2010989	01/10/10	SF
05	CO2011049	26/01/11	SF
06	CO2011144	17/05/11	SF
07	CO2011253	16/04/12	SF
08	CO2011277	31/07/12	SF

NOTES.
 1) Impedance figures are typical values.

INFORMATION CONTAINED IN THIS DOCUMENT IS CONFIDENTIAL TO RICHCO INTERNATIONAL Co. Ltd. AND MAY NOT BE DISCLOSED OR REPRODUCED IN WHOLE OR PART WITHOUT THEIR WRITTEN CONSENT.

RICHCO, INC.
 WWW.RICHCO-INC.COM

DESCRIPTION:
RT Toroid Cores, Impedance Graphs.

DRG No: 06-073		SHEET SIZE A3	
DRN NJB	DATE 30/05/06	CHKD AS	SCALE NTS
DATE 30/05/06		SHEET No. 8 OF 12	

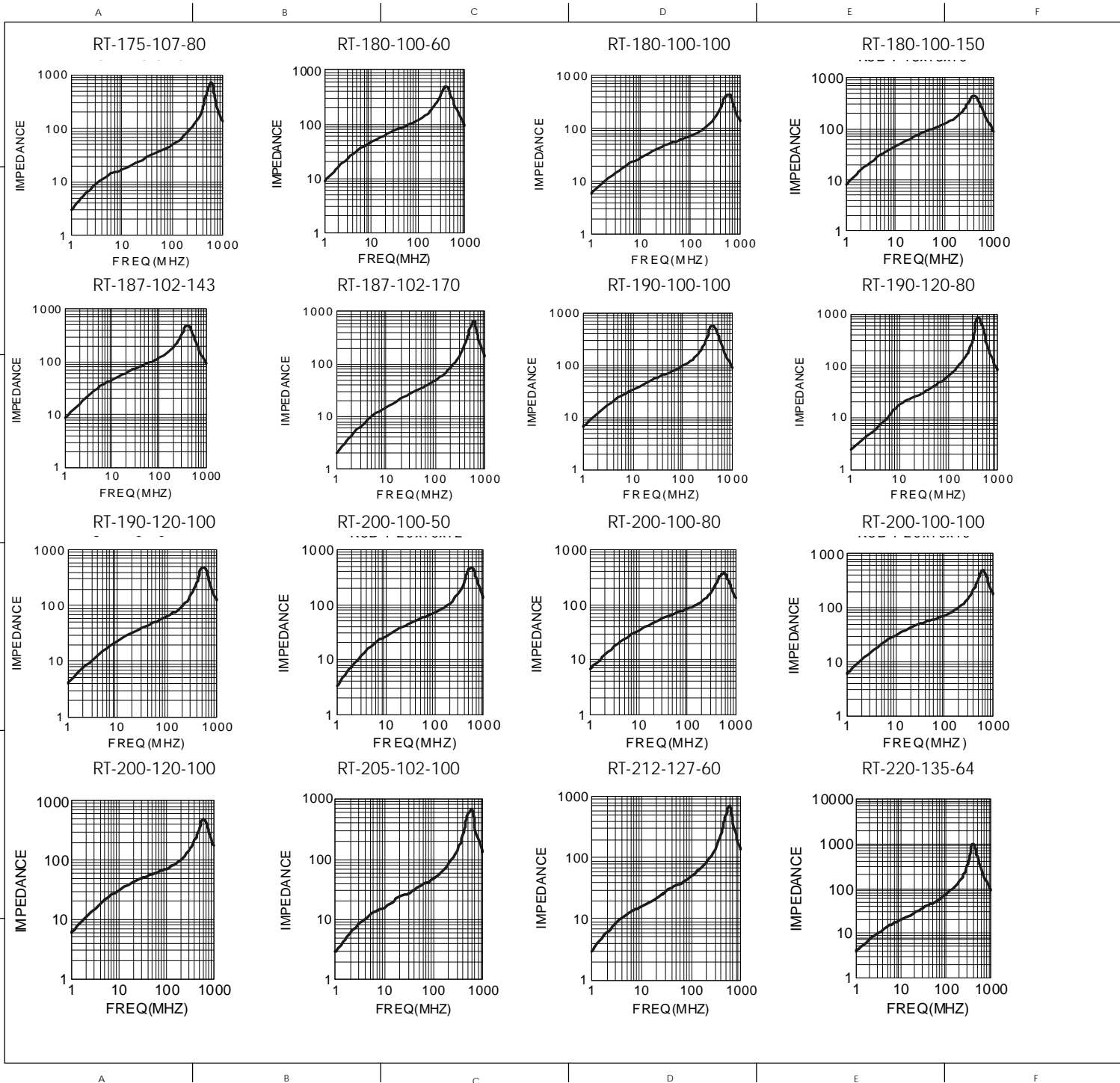

REV.	MODIFICATION.	DATE	DRN
01	NEW DRAWING	19/06/06	NJB
02	CO2010196	24/04/08	SF
03	CO2010845	20/10/09	OW
04	CO2010989	01/10/10	SF
05	CO2011049	26/01/11	SF
06	CO2011144	17/05/11	SF
07	CO2011253	16/04/12	SF
08	CO2011277	31/07/12	SF

NOTES.
 1) Impedance figures are typical values.

INFORMATION CONTAINED IN THIS DOCUMENT IS CONFIDENTIAL TO RICHCO INTERNATIONAL Co. Ltd. AND MAY NOT BE DISCLOSED OR REPRODUCED IN WHOLE OR PART WITHOUT THEIR WRITTEN CONSENT.

RICHCO, INC.
 WWW.RICHCO-INC.COM

DESCRIPTION:
 RT Toroid Cores, Impedance Graphs.

DRG No: 06-073		SHEET SIZE A3	
DRN NJB	DATE 30/05/06	CHKD AS	DATE 30/05/06
SCALE NTS		SHEET No. 9 OF 12	

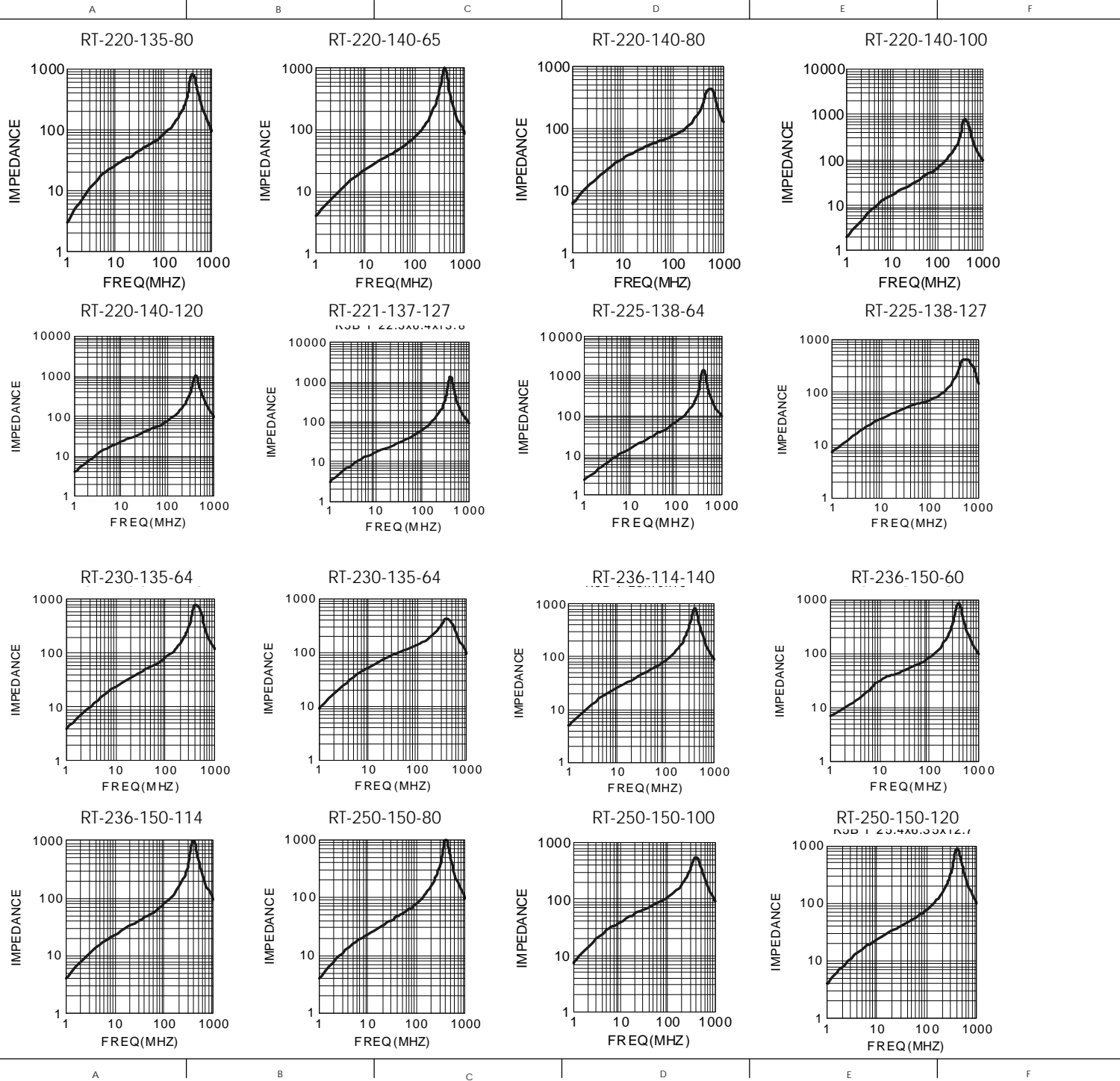

REV.	MODIFICATION.	DATE	DRN
01	NEW DRAWING	19/06/06	NJB
02	CO2010196	24/04/08	SF
03	CO2010845	20/10/09	OW
04	CO2010989	01/10/10	SF
05	CO2011049	26/01/11	SF
06	CO2011144	17/05/11	SF
07	CO2011253	16/04/12	SF
08	CO2011277	31/07/12	SF

NOTES.
 1) Impedance figures are typical values.

INFORMATION CONTAINED IN THIS DOCUMENT IS CONFIDENTIAL TO RICHCO INTERNATIONAL Co. Ltd. AND MAY NOT BE DISCLOSED OR REPRODUCED IN WHOLE OR PART WITHOUT THEIR WRITTEN CONSENT.

RICHCO, INC.
 WWW.RICHCO-INC.COM

DESCRIPTION:
 RT Toroid Cores, Impedance Graphs.

DRG No: 06-073	SHEET SIZE A3	
DRN NJB	DATE 30/05/06	CHKD AS
DATE 30/05/06	SCALE NTS	SHEET No. 10 OF 12

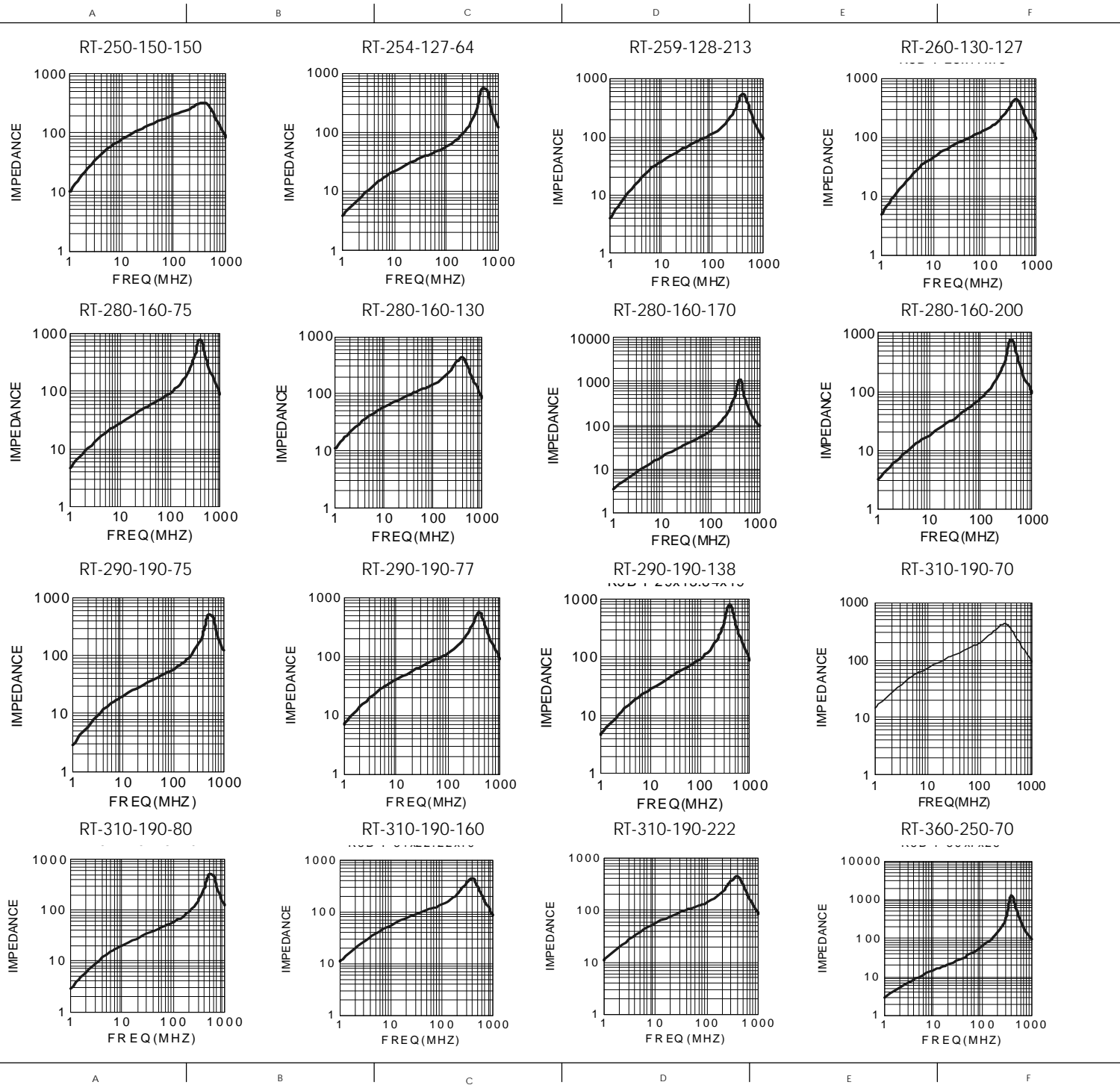

REV.	MODIFICATION.	DATE	DRN
01	NEW DRAWING	19/06/06	NJB
02	CO2010196	24/04/08	SF
03	CO2010845	20/10/09	OW
04	CO2010989	01/10/10	SF
05	CO2011049	26/01/11	SF
06	CO2011144	17/05/11	SF
07	CO2011253	16/04/12	SF
08	CO2011277	31/07/12	SF

NOTES.
 1) Impedance figures are typical values.

INFORMATION CONTAINED IN THIS DOCUMENT IS CONFIDENTIAL TO RICHCO INTERNATIONAL Co. Ltd. AND MAY NOT BE DISCLOSED OR REPRODUCED IN WHOLE OR PART WITHOUT THEIR WRITTEN CONSENT.

RICHCO, INC.
 WWW.RICHCO-INC.COM

DESCRIPTION:
RT Toroid Cores, Impedance Graphs.

DRG No: 06-073		SHEET SIZE A3	
DRN NJB	DATE 30/05/06	CHKD AS	SCALE NTS
DATE 30/05/06		SHEET No. 11 OF 12	

RT-360-250-127

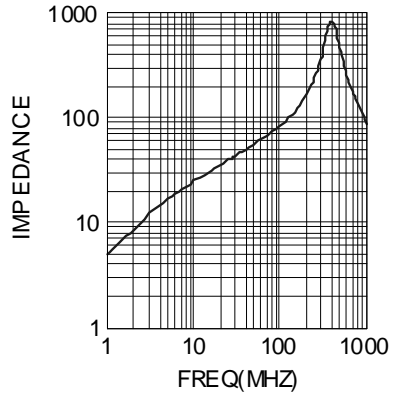

RT-406-274-150

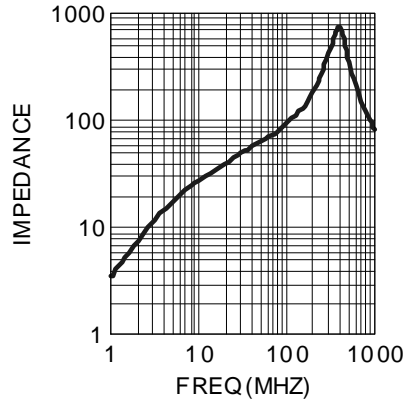

RT-594-348-128

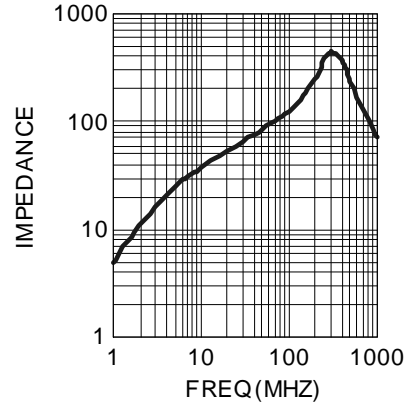

REV.	MODIFICATION.	DATE	DRN
01	NEW DRAWING	19/06/06	NJB
02	CO2010196	24/04/08	SF
03	CO2010845	20/10/09	OW
04	CO2010989	01/10/10	SF
05	CO2011049	26/01/11	SF
06	CO2011144	17/05/11	SF
07	CO2011253	16/04/12	SF
08	CO2011277	31/07/12	SF

NOTES.
1) Impedance figures are typical values.

INFORMATION CONTAINED IN THIS DOCUMENT IS CONFIDENTIAL TO RICHCO INTERNATIONAL Co. Ltd. AND MAY NOT BE DISCLOSED OR REPRODUCED IN WHOLE OR PART WITHOUT THEIR WRITTEN CONSENT.

RICHCO, INC.
WWW.RICHCO-INC.COM

DESCRIPTION:
RT Toroid Cores, Impedance Graphs.

DRG No: 06-073				SHEET SIZE A3
DRN NJB	DATE 30/05/06	CHKD AS	DATE 30/05/06	SCALE NTS
				SHEET No. 12 OF 12