



S1C / S / BNB Special Nose



S1C / SHL / BBB Special Nose



S1C / SH / BBB with EMI / RFI Screen



EMI / RFI Screen



Coloured Nuts



Slotted Ring Nut



Hex Chrome Nut

The **CLIFF®** range of S1C StackJacks™ incorporate new design features. The narrow-bodied design supports auto insertion and offers the highest board packing density available. Designed for snap-in PCB mounting to facilitate assembly and wave soldering, the S1C is available with chassis grounding and a choice of switching configurations, nose and mounting nut options.

Significant features include:

- Narrow body dual stacked versions offering the highest board packing density available.
- Snap-in PCB mounting to facilitate assembly and wave soldering.
- Optional chassis grounding versions.
- Body design supports auto-insertion.
- Choice of nose and fixing nut options.
- Tin plated, Self-Cleaning Contacts for superior performance and reliability.

Cliff Electronic Components, Ltd

76 Holmethorpe Avenue, Holmethorpe Ind. Est.
Redhill, Surrey RH1 2PF England

Tel: +44 (0) 1737 771375

Fax: +44 (0) 1737 766012

Email: sales@cliffuk.co.uk



Visit us online at:

www.cliffuk.co.uk

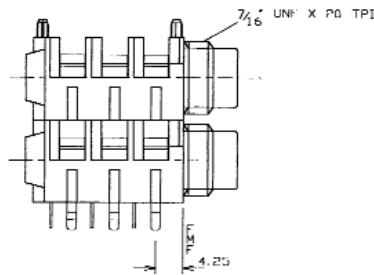

S1C / S

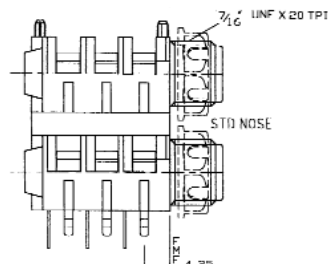
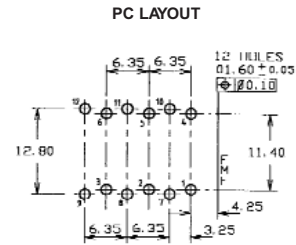
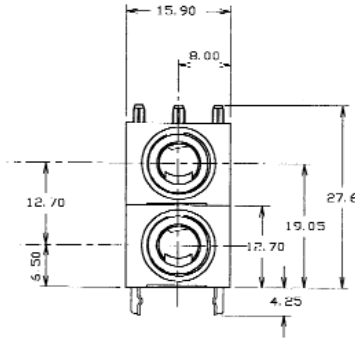

S1C / SHL

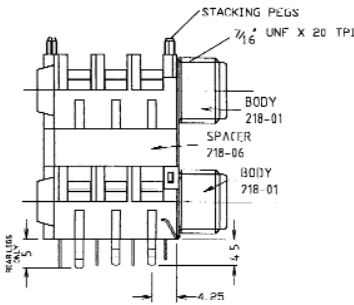
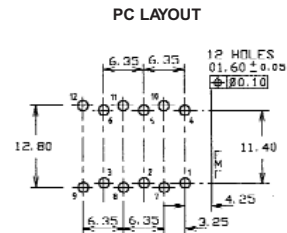
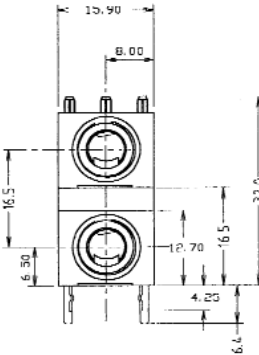

S1C / SH with EMI / RFI Screen

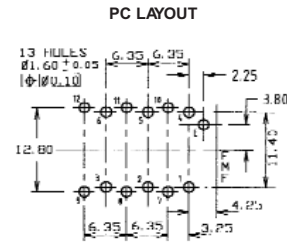
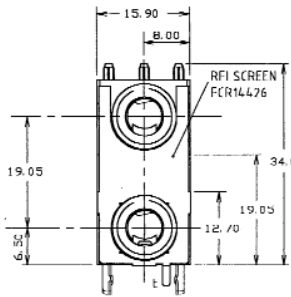

Specification:

Withstand Voltage: 2000V DC Min

Maximum current: 5 amp.

Temperature Rating: -10°C to +70°C

Life: >10,000 operations, Contact resistance <100mΩ

Initial Contact Resistance: <50mΩ

Body: Nylon 66 - Flame Rating - UL 94 V-2

Contacts: Phosphor Bronze Alloy, Tin Plated

RoHS compliant: Yes

Patent No.: USA - 6116959, UK - 2314464

Technical Data:

Designed to receive both mono and stereo 1/4" jack plugs, the S1C StackJack™ is produced from durable UL approved, Grade 1 Nylon with tin plated alloy contacts as standard, for superior performance and reliability. The S1C is available with either a half or fully threaded nose and with a nylon nut (standard) or a nickel plated brass hexagonal or slotted ring nut.

Mounting hardware, if required, is supplied unassembled. The S1C can also be supplied pre-fitted with an EMI/RFI screen.

When ordering, please state the contact arrangement required, with a plug inserted, using the following code viewed from the front of the jack socket: B - Break, N - No Contact.

For Example, and S1C/SH/BNBX2 is a dual 2-pole stacked mono switched jack socket, 1st contact - Break, 2nd contact - None, and 3rd contact - Break.