



Page 7-4 to 7 and 11
7-28 to 30 and 33

BUTTON ACTUATORS Ø22mm

- Spring return flush, extended and shrouded
- Push-push flush and extended
- Mushroom-head
- Mechanical reset
- Illuminated.



Page 7-8 and 12
7-31 and 34

DOUBLE AND TRIPLE TOUCH ACTUATORS Ø22mm

- Double touch with or without indicator
- Triple touch.



Page 7-9 and 12
7-32 and 35

SELECTOR SWITCHES Ø22mm

- Short lever
- Long lever
- Key
- Knob
- Illuminated.



Page 7-13 to 15

PILOT LIGHTS Ø22mm

- Monoblock LED.

MONOBLOCK BUZZERS Ø22mm

- Continuous or pulse tone.

COMMUNICATION INTERFACES Ø22mm

- USB
- RJ45.



Page 7-16 to 24
7-38 to 43

ADD-ON ELEMENTS, ACCESSORIES AND SPARE PARTS FOR PUSHBUTTONS AND SELECTOR SWITCHES

- Mounting adapter
- Contact elements
- LED integrated elements
- Lamp holders
- Labelling and label holders
- Bulbs.



Page 7-25

CONTROL STATIONS

- 1 to 6 holes option without actuators
- Complete units with 1 button.



Page 7-14
7-36

POTENTIOMETERS Ø22mm

- Potentiometer included in the product with graduated scale.
- Metal potentiometer drives with:
 - graduated scale
 - variable index.



Page 7-37

METAL JOYSTICKS Ø22mm

- 2 directions
- 4 directions
- 2 directions with mechanical interlock
- 4 directions with mechanical interlock
- Complete with contact elements.



- Simple and snap on installation
- Highly conductive contacts
- Robust for severe ambient conditions
- Contact operation: double breaking action, direct opening operation and self cleaning.

PLatinum Ø22mm series

	SEC. - PAGE
Pushbutton actuators, spring return	7 - 4
Push-push button actuators	7 - 4
Mechanical reset button, spring return	7 - 5
Pushbutton actuators with symbol, spring return	7 - 5
Mushroom-head pushbutton actuators	7 - 7
Double and triple-touch button actuators, spring return	7 - 8
Selector switch actuators	7 - 9
Selector switch actuator knobs	7 - 10
Illuminated button actuators, spring return	7 - 11
Illuminated push-push button actuators	7 - 11
Illuminated mushroom-head actuators	7 - 11
Double-touch button actuators, spring return, with indicator	7 - 12
Illuminated selector actuators	7 - 12
Pilot light heads	7 - 13
Monoblock LED pilot lights, steady light	7 - 13
Monoblock potentiometers	7 - 14
Monoblock buzzers	7 - 15
USB-RJ45 communication interfaces	7 - 15
Accessories, spare parts and labels	7 - 16
Mounting adapter and contact, LED, test elements	7 - 20
PLatinum series control stations	7 - 25

8 LM Ø22mm metal series

Pushbutton actuators, spring return	7 - 28
Push-push button actuators	7 - 28
Mechanical reset button, spring return	7 - 29
Pushbutton actuators with symbol, spring return	7 - 29
Mushroom-head pushbutton actuators	7 - 30
Double and triple-touch button actuators, spring return	7 - 31
Selector switch actuators	7 - 32
Illuminated button actuators, spring return	7 - 33
Illuminated push-push actuators	7 - 33
Illuminated mushroom-head actuators	7 - 34
Double-touch button actuators, spring return, with indicator	7 - 34
Illuminated selector actuators	7 - 35
Pilot light heads	7 - 36
Potentiometer drives	7 - 36
Joysticks	7 - 37
Accessories, spare parts and labels	7 - 38
Mounting adapter and contact - lamp holder - test elements	7 - 41
Dimensions	7 - 46
Wiring diagrams	7 - 51

QUALITY TOUCH!



● LOW ACTUATOR PROFILE

The external actuator bezel has a low profile and reduced front thickness.



● CUSTOMISING CAPABILITY

To simplify stock management, the series includes actuators without cap or lens and separate caps and lenses for quick installation or replacement on spring return and push-push types; all these are sold as accessories.

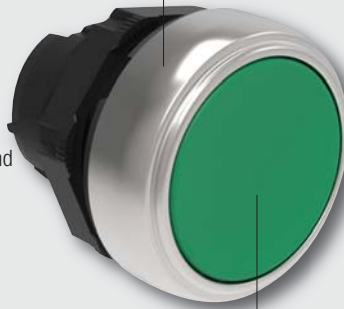

● HIGH DEGREE OF PROTECTION IP66, IP67 and IP69K

The actuators have been tested to guarantee a degree of protection per IEC/EN IP66, IP67, IP69K and UL Type 4X, appropriate for use even in extreme ambient conditions.

● ELEGANT STYLE AND ERGONOMIC DESIGN

All the series elements have an ergonomic design and, at the same time, particular care has been given to minimum detail aesthetics.

● LONG ACTUATOR MECHANICAL LIFE

High performance characteristics assure 5,000,000 cycle mechanical life for spring-return actuators, 1,000,000 for double and triple touch units and 300,000 for emergency-stop types.

● MATERIALS RESISTANT TO OILS, SOLVENTS AND HYDROCARBONS

● USAGE AT EXTREME TEMPERATURE CONDITIONS

Operation temperature range between -25° and +70°C.

● cULus, EAC, RINA and CCC CERTIFICATIONS.

7

● QUICK AND EASY ACTUATOR INSTALLATION



- Actuator fixing on the mounting surface, through a Ø22mm/0.87" drilled hole, is obtained using its **threaded ring**, easily rotated by hand or by socket spanner/wrench.



- There is an **anti-rotation fastener**, duly sized to avoid actuator rotation on the mounting surface and to give an orientation reference point for users during panel installation and during contact fitting on the actuator.
- This anti-rotation fastener collapses inside the gasket to allow fitting also when drilled holes are round without reference index.
- The sealing gasket for the actuator mounting surface has a gripping action (suction effect) offering additional adhesion properties.



- The mounting adapter and the actuators each have **clearly visible reference** indications making the snap-on fitting between the two easy and intuitive.



- Electrical contact and LED elements are **snapped onto** the mounting adapter.
- **The activation of the middle contacts is standard supplied** on all non-illuminated spring return and push-push button or selector switch actuators.

● REDUCED DIMENSIONS AND INTERAXIS

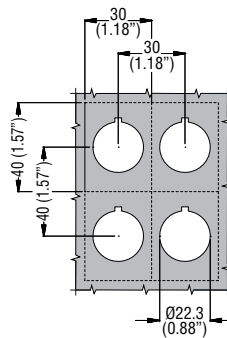

Minimum pitch:

- 30x40mm/1.18x1.57" between drillings for two actuators on a mounting surface
- 30x55mm/1.18x2.16" between drillings for two double and triple-touch actuators or when spring clamp contacts are used.

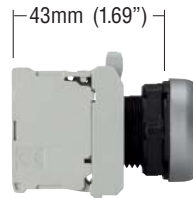

- Total depth, from the external mounting surface to the end of the first contact element is just 43mm/1.69".

● CONTACT ELEMENTS



- Miniaturised size
- High electric conductivity - 5V 1mA
- Up to 9 contact elements can be installed
- Available versions: Front and base mount with screw terminals while front-mount only with faston and spring-clamp terminals
- Contact operation: double breaking action, direct (positive) action operation and wiping effect.

● HIGH-LUMINOSITY LED ELEMENTS



- Miniaturised size
- Long electrical life: 100,000h
- Versions for base mounting and with screw or spring-clamp terminals
- Overvoltage protection
- Withstand vibrations
- Protection against stray currents in wiring
- Flickering phenomenon reduction
- Steady and flashing light versions
- Supply voltages:
 - 12...30VAC/DC
 - 85...140VAC
 - 185...265VAC
- Test elements installed beside and connected with the relative LED element allow checking if all LED elements of the installation are working properly.

DOUBLE AND TRIPLE TOUCH ACTUATORS



- IEC IP66, IP67, IP69K and UL Type 4X degree of protection
- Double touch button actuators, with 2 flush or 1 flush and 1 extended buttons
- Triple touch button actuators with 2 flush and middle extended buttons
- Versions with or without indicator.

MECHANICAL RESET BUTTONS



- Rod adjustment directly on actuator front (1...4mm/0.04...0.16").



- Up to 6 contact elements can be mounted

ADAPTER FOR DIN RAIL MOUNTING



- Permits the fitting of the Platinum and 8 LM2T series buttons on DIN rail, in panels and modular boxes. Only 35mm/1.38" wide (2 modules).

EMERGENCY STOP ACTUATORS



- Actuator structure suitable to warrant direct opening operation with mechanical latching for emergency stopping per ISO 13850 and IEC/EN 60947-5-5.
- Auto-monitor contact elements are available with functions to:
 - Constantly control the correct installation (mounting adapter and NC contact with the actuator) and proper operation of the NC contact
 - Open the circuit in the case of malfunctions (e.g. the contact detaches from the mounting adapter due to strong vibrations or shock).



- There is a green line around the actuator body to spot when the emergency stop is at rest or activated.
- Use of **Ronis keys**
- Various accessories available (e.g. yellow E-stop disks, padlockable protection and rubber actuator boots).

SHROUD



- Suitable for all Platinum and 8 LM2T mushroom-head latch buttons, guarantees protection against accidental on-board machinery contact.

SELECTOR SWITCH ACTUATORS



- Lever design assures excellent grip

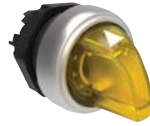

- **High visibility** on front or side and actuator inscription shows exact switch position



- Use of **Ronis keys**



- **Activation of the middle contacts is standard supplied** on 2 and 3 position selector switches.

MONOBLOCK POTENTIOMETERS



- Potentiometer included in the product.
- Protection rating IP66, IP67 and IP69K and UL Type 4X.
- Resistance values from 1 to 500kΩ.

PILOT LIGHTS



- Protection rating IP66, IP67, IP69K and UL Type 4X for LED monoblock pilot lights and pilot light heads.
- Long life and low consumption.

MONOBLOCK BUZZERS



- Continuous or pulse-tone monoblock buzzers in a single product.
- IP40 version (90dB/10cm) and IP66, IP67, IP69K and UL Type 4X, version (80dB/10cm) available.

COMMUNICATION INTERFACES



- Protection rating IP65, UL Type 4X.
- USB and RJ45 for Ethernet types with data transmission in both directions.
- USB type 3.0 (backward compatible with USB 2.0).

PLASTIC CONTROL STATIONS



- IP66, IP67, IP69K and UL Type 4X protection degrees.
- Empty pushbutton stations with 1 to 6 way option and complete control stations with various mushroom-head stop buttons
- Quick installation and wiring ease with the relative base-mount contact and LED elements, snap in place on the base
- Installation of screw and spring-clamp terminal contact and LED elements also on the internal cover surface.

Pushbutton actuators, spring return



LPC B10...



LPC B20...



LPC B30...

Order code	Colour	Qty per pkg	Wt
		n°	[kg]

Flush (without mounting adapter). Spring return.

LPC B102	Black	10	0.025
LPC B103	Green	10	0.025
LPC B104	Red	10	0.025
LPC B105	Yellow	10	0.025
LPC B106	Blue	10	0.025
LPC B108	White	10	0.025

Extended (without mounting adapter). Spring return.

LPC B202	Black	10	0.027
LPC B203	Green	10	0.027
LPC B204	Red	10	0.027
LPC B205	Yellow	1	0.027
LPC B206	Blue	1	0.027
LPC B208	White	1	0.027

Shrouded (without mounting adapter). Spring return.

LPC B302	Black	10	0.027
LPC B303	Green	10	0.027
LPC B304	Red	10	0.027
LPC B305	Yellow	1	0.027
LPC B306	Blue	1	0.027
LPC B308	White	1	0.027

Push-push button actuators



LPC Q10...



LPC Q20...

Order code	Colour	Qty per pkg	Wt
		n°	[kg]

Flush (without mounting adapter).

Push on-push off.

LPC Q102❶	Black	10	0.025
LPC Q103❶	Green	10	0.025
LPC Q104❶	Red	10	0.025
LPC Q105❶	Yellow	1	0.025
LPC Q106❶	Blue	1	0.025
LPC Q108❶	White	1	0.025

Extended (without mounting adapter).

Push on-push off.

LPC Q202❶	Black	10	0.027
LPC Q203❶	Green	10	0.027
LPC Q204❶	Red	10	0.027
LPC Q205❶	Yellow	1	0.027
LPC Q206❶	Blue	1	0.027
LPC Q208❶	White	1	0.027

❶ Use contact elements LPX C10A (EM) and LPXC01 (NC) only.

Contact elements LPX C10 (NO) and LPXC01D (LB) cannot be fitted on these actuators.

For the number of contacts that can be fitted, see the indication here to the side.

Operational characteristics

- Any mounting position allowed
- Ambient conditions:
 - Operating temperature: -25...+70°C
 - Storage temperature: -40...+85°C
- Degree of protection:
 - Per IEC/EN: IP66, IP67 and IP69K
 - Per UL/CSA: Type 1, 2, 3R, 4, 4X, 12, 12K.

Materials

Polyamide.

Mechanical endurance

- Operating force: <0.5kg/1.1lb (actuator).
Mechanical life:
- Spring return actuators: 5,000,000 cycles
 - Push-push actuators: 500,000 cycles.

Mounting adapter

See page 7-20.

Type: LPX AU120.

Actuators are installed through a Ø22mm/Ø0.87" drilling with a threaded fixing ring (Tmax = 2.3Nm/1.69lbf) also on the cover of LPZ control stations.

The mounting adapter directly snaps onto the actuator.

Contact elements for spring-return button actuators

See page 7-20, 7-23 or 7-24.

Type	Termination
Front-mount types snap onto LPX AU120 mounting adapter (to purchase separately). Up to 9 contacts can be fitted: 3 each on the left, middle and right, one behind the other.	

They can also be fitted internally on the cover surface of LPZ control stations, up to 3 elements per actuator.

1NO	LPX C10	Screw
	LPX CF10	Faston
	LPXCS10	Spring clamp
1EM	LPX C10A	Screw
1NC	LPX C01	Screw
	LPX CF01	Faston
	LPX CS01	Spring clamp
1LB	LPX C01D	Screw

Base mount types snap into LPZ control station base. See example on page 7-27.

Up to 3 contacts can be fitted per control station actuator.

1NO	LPX CB10	Screw
1NC	LPX CB01	Screw

Contact elements for push-push button actuators

See page 7-20.

Type: LPX C10A (1EM)
LPX C01 (1NC)

Contacts snap onto the adapter and also internally on the cover surface of LPZ control stations.

Up to 6 contacts can be fitted: 2 each on the left, middle and right, one behind of the other; up to 3 elements per control station actuator.

All these actuators are standard supplied with action plug for middle contacts.

Certifications and compliance

Certifications obtained: UL Listed for USA and Canada, (cULus - File E93601), as Auxiliary Devices; EAC, CCC, RINA.

Compliant with standards: IEC/EN 60947-1, IEC/EN 60947-5-1, UL508, CSA C22.2 n° 14.

Mechanical reset buttons, complete unit, spring return



LPC R1196

Order code	Colour	Qty per pkg	Wt
		n°	[kg]
Flush (5.2mm/0.2" stroke). Adjustable length 0-150mm/5.9". Complete with shaft (without mounting adapter). Spring return.			
LPC R1002	Black	10	0.038
LPC R1003	Green	10	0.038
LPC R1004	Red	10	0.038
LPC R1006	Blue	10	0.038
LPC R1196	Blue (RESET)	10	0.038
Extended (5.2mm/0.2" stroke). Adjustable length 0-150mm/5.9". Complete with shaft (without mounting adapter). Spring return.			
LPC R2004	Red	1	0.040

① With "RESET" caption on actuator.
E.g. Not suitable for LPZ control stations.

Pushbutton actuators, spring return, with symbol



LPC B11...



LPC B21...

Order code	Symbol	Colour	Qty per pkg	Wt
			n°	[kg]
Flush (without mounting adapter). Spring return.				
LPC B1102	O	Black	10	0.025
LPC B1104		Red	10	0.025
LPC B1113	I	Green	10	0.025
LPC B1118		White	10	0.025
LPC B1123	II	Green	1	0.025
LPC B1128		White	1	0.025
LPC B1132	STOP	Black	1	0.025
LPC B1134		Red	10	0.025
LPC B1142	← ①	Black	10	0.025
LPC B1148		White	10	0.025
LPC B1152	↑ ②	Black	10	0.025
LPC B1158		White	10	0.025
LPC B1163	START	Green	10	0.025
LPC B1168		White	1	0.025
LPC B1176	R	Blue	1	0.025
LPC B1178		White	1	0.025
LPC B1196	RESET	Blue	10	0.025
LPC B1502	↔	Black	10	0.025
LPC B1512	↔	Black	10	0.025
Extended (without mounting adapter). Spring return.				
LPC B2102	O	Black	10	0.027
LPC B2104		Red	10	0.027
LPC B2132	STOP	Black	1	0.027
LPC B2134		Red	10	0.027

① Arrow symbol can be used to indicate right or left.
② Arrow symbol can be used to indicate up or down.

Operational characteristics

- Any mounting position allowed
- Fine rod adjustment (1-4mm/0.04-0.16") on front with screwdriver by removing actuator cap for mechanical reset buttons
- Ambient conditions:
 - Operating temperature: -25...+70°C
 - Storage temperature: -40...+85°C
- Degree of protection:
 - Per IEC/EN: IP66, IP67 and IP69K
 - Per UL: Type 1, 2, 3R, 4, 4X, 12, 12K.

Mechanical endurance

Operating force: <0.5kg/1.1lb (actuator).
Mechanical life: 5,000,000 cycles.

Mounting adapter

See page 7-20.
Type: LPX AU120.

Actuators are installed through a Ø22mm/Ø0.87" drilling with a threaded fixing ring (Tmax = 2.3Nm/1.69lbf) also on the cover of LPZ control stations except for LPC R... types.

The mounting adapter directly snaps onto the actuator.

Contact elements for mechanical reset buttons

See page 7-20 or 7-23.

Type	Termination	
1NO	LPX C10	Screw
	LPX CF10	Faston
	LPX CS10	Spring clamp
1EM	LPX C10A	Screw
1NC	LPX C01	Screw
	LPX CF01	Faston
1LB	LPX CS01	Spring clamp
	LPX C01D	Screw

Front mount types snap onto LPX AU120 mounting adapter (to purchase separately), if any contacts are needed.

Up to 6 contacts can be fitted: 3 each on the left and right, one behind the other.

Contact elements for spring-return button actuators

See pages 7-20, 7-23 or 7-24.

Type	Termination	
1NO	LPX C10	Screw
	LPX CF10	Faston
	LPX CS10	Spring clamp
1EM	LPX C10A	Screw
1NC	LPX C01	Screw
	LPX CF01	Faston
1LB	LPX CS01	Spring clamp
	LPX C01D	Screw

Front-mount types snap onto LPX AU120 mounting adapter (to purchase separately).

Up to 9 contacts can be fitted: 3 each on the left, middle and right; one behind the other.

They can also be fitted internally on the cover surface of control stations LPZ, up to 3 elements per actuator.

Base-mount types snap into LPZ control station base. See example on page 7-27.

Up to 3 contacts can be fitted per control station actuator.

1NO	LPX CB10	Screw
1NC	LPX CB01	Screw

The LPC B... actuators are standard supplied with action plug for middle contacts.

Certifications and compliance

Certifications obtained: UL Listed for USA and Canada, (cULus - File E93601), as Auxiliary Devices; EAC, CCC, RINA.

Compliant with standards: IEC/EN 60947-1, IEC/EN 60947-5-1, UL508, CSA C22.2 n° 14.

Pushbutton actuators, spring return, with symbol



LPC B1253

7

Order code	Symbol	Colour	Qty per pkg	Wt
			n°	[kg]
Spring return (without mounting adapter).				
LPCB100180	⚡	⊗	50	0.027
LPCB100200	OPEN	⊗	50	0.027
LPCB100210	CLOSED	⊗	50	0.027
LPCB100220	↗	⊗	50	0.027
LPCB100230	☐	⊗	50	0.027
LPCB100250	+	⊗	50	0.027
LPCB100260	-	⊗	50	0.027
LPCB100270	⚡	⊗	50	0.027
LPCB100280	☀	⊗	50	0.027
LPCB100290	☀	⊗	50	0.027
LPCB100300	AUTO ↑	⊗	50	0.027
LPCB100310	BASED ↓	⊗	50	0.027
LPCB100320	←	⊗	50	0.027
LPCB100330	→	⊗	50	0.027
LPCB100340	MAN	⊗	50	0.027
LPCB100350	AUTO	⊗	50	0.027
LPCB100380	TRIP	⊗	50	0.027
LPCB100390	TEST	⊗	50	0.027
LPCB100400	⚠	⊗	50	0.027
LPCB100410	↑	⊗	50	0.027
LPCB100420	⊕	⊗	50	0.027
LPCB100430	⊗	⊗	50	0.027
LPCB100440	⚡	⊗	50	0.027
LPCB100450	⚡	⊗	50	0.027
LPCB100460	⊗	⊗	50	0.027
LPCB100470	⊕	⊗	50	0.027
LPCB100480	↔	⊗	50	0.027
LPCB100490	↑↓	⊗	50	0.027
LPCB100520	⚡	⊗	50	0.027
LPCB100530	↓	⊗	50	0.027
LPCB100540	⊕	⊗	50	0.027
LPCB100550	☞	⊗	50	0.027
LPCB100560	START STOP	⊗	50	0.027
LPCB100570	III	⊗	50	0.027
LPCB100580	IV	⊗	50	0.027
LPCB100590	↔	⊗	50	0.027
LPCB100600	⚡	⊗	50	0.027
LPCB100610	↔	⊗	50	0.027
LPCB100620	↩	⊗	50	0.027
LPCB100630	↩	⊗	50	0.027
LPCB100640	Ⓢ	⊗	50	0.027
LPCB100650	Ⓢ	⊗	50	0.027
LPCB100660	⚡	⊗	50	0.027
LPCB100670	↔	⊗	50	0.027
LPCB100680	⚠	⊗	50	0.027
LPCB100690	↔	⊗	50	0.027

- ① Add letter "L" if illuminated type is required.
 - ② For the type of actuator, add: 1 for flush or 2 for extended.
 - ③ Add the actuator colour: 2 black only for non-illuminated type; 3 green, 4 red, 5 yellow, 6 blue, 8 white or 7 transparent for illuminated version.
 - ④ Products available on specific request for a minimum multiple quantity of 50 pieces per type.
 - ⑤ Consult Customer Service for assistance; see contact details or inside front cover.
 - ⚡ Symbol indicating dangerous voltage (IEC 60417 5036-a).
- Examples of complete order codes:
 LPC B2 25 8 – extended non-illuminated white pushbutton with + symbol
 LPC BL1 68 5 – flush illuminated yellow pushbutton actuator with ⚡ symbol.

Operational characteristics

- Any mounting position allowed
- Ambient conditions:
 - Operating temperature: -25...+70°C
 - Storage temperature: -40...+85°C
- Degree of protection:
 - Per IEC/EN: IP66, IP67 and IP69K
 - Per UL/CSA: Type 1, 2, 3R, 4, 4X, 12, 12K.

Materials

Polyamide.

Mechanical endurance

Operating force: <0.5kg/1.1lb (actuator).
 Mechanical life: 5,000,000 cycles.

Mounting adapter

See page 7-20.

Type: LPX AU120.

Actuators are installed through a Ø22mm/Ø0.87" drilling with a threaded fixing ring (Tmax = 2.3Nm/1.69lbf) also on the cover of LPZ control stations.

The mounting adapter directly snaps onto the actuator.

Contact elements

See page 7-20, 7-23 or 7-24

Type	Termination
------	-------------

Front-mount types snap onto LPX AU120 mounting adapter (to purchase separately).

Up to 9 contacts can be fitted: 3 each on the left, middle and right, one behind the other.

They can also be fitted internally on the cover surface of LPZ control stations, up to 3 elements per actuator.

1NO	LPX C10	Screw
	LPX CF10	Faston
	LPX CS10	Spring clamp
1EM	LPX C10A	Screw
1NC	LPX C01	Screw
	LPX CF01	Faston
	LPX CS01	Spring clamp
1LB	LPX C01D	Screw

Base-mount types snap into LPZ control station base.
 See example on page 7-27.

Up to 3 contacts can be fitted per control station actuator.

1NO	LPX CB10	Screw
1NC	LPX CB01	Screw

All these actuators are standard supplied with action plug for middle contacts.

Certifications and compliance

Certifications obtained: UL Listed for USA and Canada, (cULus - File E93601), as Auxiliary Devices; EAC, CCC, RINA.

Compliant with standards: IEC/EN 60947-1, IEC/EN 60947-5-1, UL508, CSA C22.2 n° 14

Mushroom head pushbutton actuators



LPC B614...



LPC B674...



LPC B6344



LPC B6634



LPC B6644



LPC B684...

Order code	Colour	Qty per pkg	Wt
		n°	[kg]

SPRING RETURN.
Ø40mm/1.6" (without mounting adapter).

LPC B6142	Black	10	0.033
LPC B6143	Green	10	0.033
LPC B6144	Red	10	0.033
LPC B6145	Yellow	10	0.033
LPC B6146	Blue	10	0.033

Ø60mm/2.4" (without mounting adapter).

LPC B6162	Black	10	0.038
LPC B6163	Green	10	0.038
LPC B6164	Red	10	0.038
LPC B6165	Yellow	10	0.038
LPC B6166	Blue	10	0.038

LATCH, PULL TO RELEASE
Ø40mm/1.6" (without mounting adapter).
For normal stopping.

LPC B6742	Black	10	0.097
LPC B6744	Red	10	0.097

LATCH, TURN TO RELEASE
Ø40mm/1.6" (without mounting adapter).
For normal stopping.

LPC B6342	Black	10	0.046
LPC B6344	Red	10	0.046

Ø30mm/1.2" (without mounting adapter).
For emergency stopping, ISO 13850 compliant.

LPC B6634	Red	10	0.079
-----------	-----	----	-------

Ø40mm/1.6" (without mounting adapter).
For emergency stopping, ISO 13850 compliant.

LPC B6644	Red	10	0.079
-----------	-----	----	-------

LATCH, TURN KEY TO RELEASE
Ø40mm/1.6" (without mounting adapter). Key code n° 455.
For normal stopping.

LPC B6842	Black	10	0.083
LPC B6842R	Black	1	0.083

For emergency stopping, ISO 13850 compliant.

LPC B6844	Red	10	0.083
LPC B6844R	Red	1	0.083

Ⓢ Versions with different key codes.
Complete with the numeric code of the key.
The following versions are available: 421E, 458A, 520E, 3131A, 3433E.
Example of complete code: LPC B6844R 421E.

Operational characteristics

- Any mounting position allowed
- Ambient conditions:
 - Operating temperature: -25...+70°C
 - Storage temperature: -40...+85°C
- Degree of protection:
 - Per IEC/EN: IP66, IP67 and IP69K
 - Per UL: Type 1, 2, 3R, 4, 4X, 12, 12K.

Materials

Polyamide.

Mechanical endurance

- Operating force: <0.5kg/1.1lb (actuator).
Mechanical life:
- Mushroom head spring return buttons: 5,000,000 cycles
 - Mushroom head latch buttons: 300,000 cycles.

Mounting adapter

See page 7-20.

Type: LPX AU120.

Actuators are installed through a Ø22mm/Ø0.87" drilling with a threaded fixing ring (Tmax = 2.3Nm/1.69lbf) also on the cover of LPZ control stations.

The mounting adapter directly snaps onto the actuator.

Contact elements

See page 7-20, 7-23 or 7-24.

Type	Termination
------	-------------

Front-mount types snap onto LPX AU120 mounting adapter (to purchase separately). For SPRING-RETURN types, up to 9 contacts can be fitted: 3 each on the left, middle and right, one behind the other.

For LATCH types, up to 4 contacts can be fitted.

They can also be fitted internally on the cover surface of LPZ control stations, up to 3 elements per actuator.

1NO	LPX C10	Screw
	LPX CF10	Faston
	LPXCS10	Spring clamp
1EM	LPX C10A	Screw
1NC	LPX C01	Screw
	LPX CF01	Faston
1LB	LPX CS01	Spring clamp
	LPX C01D	Screw

Base-mount types snap into LPZ control station base.
See example on page 7-27.

Up to 3 contacts can be fitted per control station actuator.

1NO	LPX CB10	Screw
1NC	LPX CB01	Screw

AUTO-MONITOR CONTACT with MUSHROOM-HEAD LATCH TYPES only: 2 elements max of this type can be mounted.

Extra two contacts can be fitted on the right.
Two elements per actuator can be fixed internally on the cover surface of LPZ control stations of which one auto-monitor type. No LED element can be installed.

Auto-monitor 1NC

Auto-monitor 1NC	LPX C01SM	Screw (2 stacked in the middle - LPX AU120 pos. 1/3-4/6)
1NO	LPX C10	Screw (2 stacked on the right)
	LPX CF10	Faston (2 stacked on the right)
1NC	LPX C01	Screw (2 stacked on the right)
	LPX CF01	Faston (2 stacked on the right)

AUTO-MONITOR CONTACT with MUSHROOM-HEAD LATCH TYPES only: 2 elements max of this type can be mounted.
Only one of this type per actuator can be fixed internally on the cover surface of LPZ control stations. No LED element can be installed.

Auto-monitor 2NC	LPX C02SM	Screw (2 stacked)
------------------	-----------	-------------------

All these actuators are standard-supplied with action plug for middle contacts.

Certifications and compliance

Certifications obtained: UL Listed for USA and Canada, (cULus - File E93601), as Auxiliary Devices; EAC, CCC, RINA.

Compliant with standards: IEC/EN 60947-1, IEC/EN 60947-5-1, UL508, CSA C22.2 n° 14.

Normal operation of auto-monitor contact mounted on surface or on cover of control stations

In case of detachment of only the contact element and/or of the mounting adapter with contact element

With contact type LPX C01SM

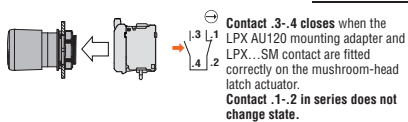

If the contact LPX C01SM detaches from the actuator due to **strong vibrations or shock**, the equipment can be restored to operating state only when proper mounting of the contact with the actuator is re-established resulting in **contact 3-4 closing**.

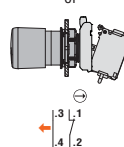
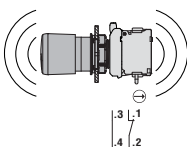
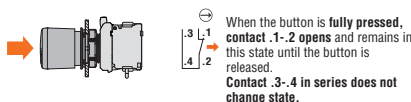
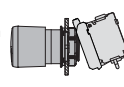

With contact type LPX C02SM

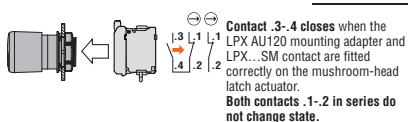

If the contact LPX C02SM detaches from the actuator due to **strong vibrations or shock**, the equipment can be restored to operating state only when proper mounting of the contact with the actuator is re-established resulting in **contact 3-4 closing**.

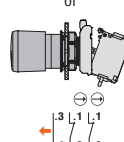
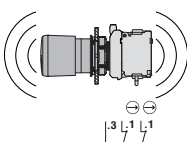
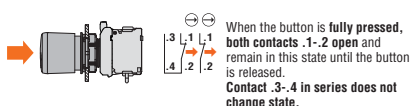
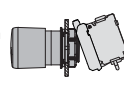

Double-touch actuators, spring return



LPC B71...



LPC B72...

Order code	Colour	Symbols	Qty per pkg	Wt
			n°	[kg]

Two flush pushbuttons (without mounting adapter). Both spring return.

LPC B7112	Black/Red	—	5	0.030
LPC B7113	Green/Red	—	5	0.030
LPC B7114	White/Black	—	5	0.030
LPC B7122	Black/Red	I-O	5	0.030
LPC B7123	Green/Red	I-O	5	0.030
LPC B7124	White/Black	I-O	5	0.030
LPC B7133	Green/Red	Start/Stop	5	0.030

One extended and one flush pushbuttons (without mounting adapter). Both spring return.

LPC B7212	Black/Red	—	1	0.030
LPC B7213	Green/Red	—	5	0.030
LPC B7214	White/Black	—	1	0.030
LPC B7222	Black/Red	I-O	5	0.030
LPC B7223	Green/Red	I-O	5	0.030
LPC B7224	White/Black	I-O	1	0.030
LPC B7233	Green/Red	Start/Stop	5	0.030

Operational characteristics

- Any mounting position allowed
- Ambient conditions:
 - Operating temperature: -25...+70°C
 - Storage temperature: -40...+85°C
- Degree of protection:
 - Per IEC/EN: IP66, IP67 and IP69K
 - Per UL: Type 1, 2, 3R, 4, 4X, 12, 12K.

Materials

Polyamide.

Mechanical endurance

Operating force: <0.5kg/1.1lb (actuator).
Mechanical life: 1,000,000 cycles.

Mounting adapter

See page 7-20.

Type: LPX AU120.

Actuators are installed through a Ø22mm/Ø0.87" drilling with a threaded fixing ring (Tmax = 2.3Nm/1.69lbf) also on the cover of LPZ control stations.

The mounting adapter directly snaps onto the actuator.

Contact elements

See page 7-20, 7-23 or 7-24.

Type	Termination
------	-------------

Front-mount types snap onto LPX AU120 mounting adapter (to purchase separately).

For DOUBLE-TOUCH actuators, up to 6 contacts can be fitted: 3 on the left, 3 on the right.

For TRIPLE-TOUCH actuators, up to 9 contacts can be fitted: 3 each on the left, middle and right, one behind the other. They can also be fitted internally on the cover surface of LPZ control stations: 2 for double-touch and 3 elements for triple-touch.

1NO	LPX C10	Screw
	LPX CF10	Faston
	LPXCS10	Spring clamp
1EM	LPX C10A	Screw
1NC	LPX C01	Screw
	LPX CF01	Faston
	LPX CS01	Spring clamp
1LB	LPX C01D	Screw

Base-mount types snap into LPZ control station base. See example on page 7-27.

For DOUBLE-TOUCH actuators, 2 contacts need to be fitted, one on the left and one on the right.

For TRIPLE-TOUCH actuators, 3 contacts need to be fitted: one each on the left, middle and right.

1NO	LPX CB10	Screw
1NC	LPX CB01	Screw

Certifications and compliance

Certifications obtained: UL Listed for USA and Canada, (cULus - File E93601), as Auxiliary Devices; EAC, CCC, RINA.

Compliant with standards: IEC/EN 60947-1, IEC/EN 60947-5-1, UL508, CSA C22.2 n° 14.

Triple-touch actuators, spring return



LPC B73...

Order code	Symbols	Qty per pkg	Wt
		n°	[kg]

One middle extended buttons (without mounting adapter). Spring return.

LPC B7345		5	0.030
LPC B7355		5	0.030
LPC B7365		5	0.030
LPC B7375		5	0.030

Selector switch actuators lever



LPC S1...

Order code	Type of positions	Qty per pkg	Wt
		n°	[kg]
2 position (without mounting adapter).			
LPC S120	∇	10	0.037
LPC S121	∇	10	0.037
3 position (without mounting adapter).			
LPC S130	∇	10	0.037
LPC S131	∇	10	0.037
LPC S132	∇	10	0.037
LPC S133	∇	10	0.037

Selector switch actuators long lever



LPC S2...

Order code	Type of positions	Qty per pkg	Wt
		n°	[kg]
2 position (without mounting adapter).			
LPC S220	∇	10	0.040
LPC S221	∇	10	0.040
3 position (without mounting adapter).			
LPC S230	∇	10	0.040
LPC S231	∇	10	0.040
LPC S232	∇	10	0.040
LPC S233	∇	10	0.040

Selector switch actuators key



LPC S3...

Order code	Type of position	Qty per pkg	Wt
		n°	[kg]
2 position (without mounting adapter).			
LPC S320	∇	10	0.060
LPC S320R⓪	∇	1	0.060
LPC S321	∇	10	0.060
LPC S321R⓪	∇	1	0.060
LPC S340	∇	10	0.060
LPC S340R⓪	∇	1	0.060
3 position (without mounting adapter).			
LPC S330	∇	10	0.060
LPC S330R⓪	∇	1	0.060
LPC S331	∇	10	0.060
LPC S331R⓪	∇	1	0.060
LPC S332⓪	∇	10	0.060
LPC S332R⓪⓪	∇	1	0.060
LPC S333⓪	∇	10	0.060
LPC S333R⓪⓪	∇	1	0.060
LPC S350	∇	10	0.060
LPC S350R⓪	∇	1	0.060
LPC S360	∇	10	0.060
LPC S360R⓪	∇	1	0.060
LPC S370⓪	∇	10	0.060
LPC S370R⓪⓪	∇	1	0.060
LPC S380⓪	∇	10	0.060
LPC S380R⓪⓪	∇	1	0.060
LPC S390⓪	∇	10	0.060
LPC S390R⓪⓪	∇	1	0.060

⓪ Versions with different key codes. Complete with the numeric code of the key. The following versions are available: 421E, 458A, 520E, 3131A, 3433E. Example of complete code: LPC S320 R421E.
 ⓪ Available only on specific request

Contact activation of 2-position selector switch

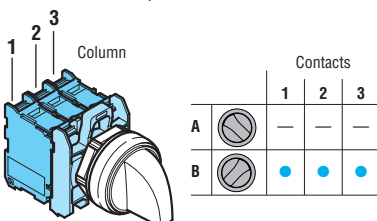

Contact activation of 3-position selector switch

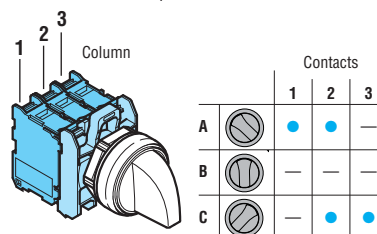

Operational characteristics

- Any mounting position allowed
- Standard key types supplied with key code n° 455
- Ambient conditions:
 - Operating temperature: -25...+70°C
 - Storage temperature: -40...+85°C
- Degree of protection:
 - Per IEC/EN: IP66, IP67 and IP69K
 - Per UL: Type 1, 2, 3R, 4, 4X, 12, 12K.

Materials

Polyamide.

Mechanical endurance

Mechanical life: 1,000,000 cycles.

Mounting adapter

See page 7-20.

Type: LPX AU120.

Actuators are installed through a Ø22mm/Ø0.87" drilling with a threaded fixing ring (Tmax = 2.3Nm/1.69lbf) also on the cover of LPZ control stations.

The mounting adapter directly snaps onto the actuator.

Contact elements

See page 7-20, 7-23 or 7-24.

Type	Termination
1NO	LPX C10 Screw
	LPX CF10 Faston
	LPXCS10 Spring clamp
1EM	LPX C10A Screw
1NC	LPX C01 Screw
	LPX CF01 Faston
	LPX CS01 Spring clamp
1LB	LPX C01D Screw

Base-mount types snap into LPZ control station base. See example on page 7-27.

Up to 3 contacts can be fitted per control station actuator.

1NO	LPX CB10	Screw
1NC	LPX CB01	Screw

Activation of the middle contacts is coupled to the side contacts; the relative mechanism pins are standard supplied.



The middle contact activation, with respect to the right and left side contact, can be changed by the user, if required, by removing one or both mechanism pins. Consult the relative instructions available online in the Downloads section at www.LovatoElectric.com.

Type of position

- ∇ Maintained position.
- ∇ Spring return position.
- Key extraction position.

Rotation angles

2 position



3 position



Special versions

Versions with coloured keys are available upon request. Consult Customer Service; see contact details on inside front cover.

Certifications and compliance

Certifications obtained: UL Listed for USA and Canada, (cULus - File E93601), as Auxiliary Devices; EAC, CCC, RINA. Compliant with standards: IEC/EN 60947-1, IEC/EN 60947-5-1, UL508, CSA C22.2 n° 14.

Selector switch actuators knob



new

LPC S4...

Order code	Type of positions	Qty per pkg	Wt
		n°	[kg]
2 position (without mounting adapter)			
LPC S420	∇	10	0.037
LPC S421	∇	10	0.037
3 position (without mounting adapter)			
LPC S430	∇	10	0.037
LPC S431	∇	10	0.037
LPC S432	∇	10	0.037
LPC S433	∇	10	0.037

Contact activation of 2-position selector switch

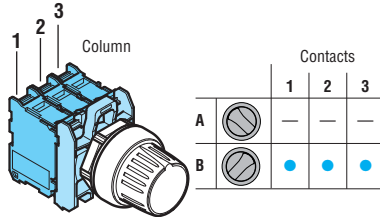

Contact activation of 3-position selector switch

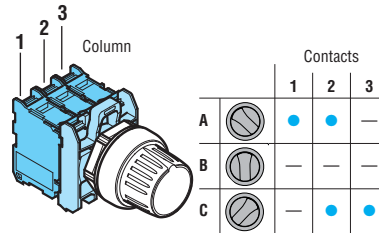

Operational characteristics

- Any mounting position allowed
- Ambient conditions:
 - Operating temperature: -25...+70°C
 - Storage temperature: -40...+85°C
- Degree of protection:
 - Per IEC/EN: IP66, IP67 and IP69K
 - Per UL: Type 1, 2, 3R, 4, 4X, 12, 12K.

Materials

Polyamide.

Mechanical endurance

Mechanical life: 1,000,000 cycles.

Mounting adapter

See page 7-20.

Type: LPX AU120.

Actuators are installed through a Ø22mm/Ø0.87" drilling with a threaded fixing ring (Tmax = 2.3Nm/1.69lbf) also on the cover of LPZ control stations.

The mounting adapter directly snaps onto the actuator.

Contact elements

See page 7-20, 7-23 or 7-24.

Type	Termination
------	-------------

Front-mount types snap onto LPX AU120 mounting adapter (to purchase separately). Up to 6 contacts can be fitted: 2 each on the left, middle and right or 3 each on the left and right, one behind the other.

They can also be fitted internally on the cover surface of LPZ control stations, up to 3 elements per actuator.

1NO	LPX C10	Screw
	LPX CF10	Faston
	LPXCS10	Spring clamp
1EM	LPX C10A	Screw
1NC	LPX C01	Screw
	LPX CF01	Faston
	LPX CS01	Spring clamp
1LB	LPX C01D	Screw

Base-mount types snap into LPZ control station base. See example on page 7-27.

Up to 3 contacts can be fitted per control station actuator.

1NO	LPX CB10	Screw
1NC	LPX CB01	Screw

Activation of the middle contacts is coupled to the side contacts; the relative mechanism pins are standard supplied.



The middle contact activation, with respect to the right and left side contact, can be changed by the user, if required, by removing one or both mechanism pins. Consult the relative instructions available online in the Downloads section at www.LovatoElectric.com.

Type of position

- ∇ Maintained position.
- ∇ Spring return position.

Rotation angles

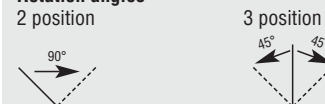

Certifications and compliance

Certifications obtained: UL Listed for USA and Canada, (cULus - File E93601), as Auxiliary Devices; EAC, CCC (pending), RINA (pending).

Compliant with standards: IEC/EN 60947-1, IEC/EN 60947-5-1, UL508, CSA C22.2 n° 14.

Illuminated button actuators, spring return



LPC BL10...



LPC BL20...

Order code	Colour	Qty per pkg	Wt
		n°	[kg]
Flush (without mounting adapter). Spring return.			
LPC BL103	Green	10	0.025
LPC BL104	Red	10	0.025
LPC BL105	Yellow	10	0.025
LPC BL106	Blue	10	0.025
LPC BL107	Transparent	10	0.025
Extended (without mounting adapter). Spring return.			
LPC BL203	Green	10	0.027
LPC BL204	Red	10	0.027
LPC BL205	Yellow	10	0.027
LPC BL206	Blue	10	0.027
LPC BL207	Transparent	10	0.027

Illuminated push-push button actuators



LPC QL10...



LPC QL20...

Order code	Colour	Qty per pkg	Wt
		n°	[kg]
Flush (without mounting adapter). Push on-push off.			
LPC QL103	Green	10	0.025
LPC QL104	Red	10	0.025
LPC QL105	Yellow	10	0.025
LPC QL106	Blue	10	0.025
LPC QL107	Transparent	10	0.025
Extended (without mounting adapter). Push on-push off.			
LPC QL203	Green	10	0.027
LPC QL204	Red	10	0.027
LPC QL205	Yellow	10	0.027
LPC QL206	Blue	10	0.027
LPC QL207	Transparent	10	0.027

❶ Use contact elements LPX C10A (EM) and LPXC01 (NC) only.
Contact elements LPX C10 (NO) and LPX C01D (LB) cannot be fitted on these actuators.

Illuminated mushroom head button actuators



LPC BL614...



LPC BL664...

Order code	Colour	Qty per pkg	Wt
		n°	[kg]
SPRING RETURN. Ø40mm/1.6" (without mounting adapter).			
LPC BL6143	Green	10	0.035
LPC BL6144	Red	10	0.035
LPC BL6145	Yellow	10	0.035
LPC BL6146	Blue	10	0.035
LPC BL6148	White	1	0.035
LATCH, TURN TO RELEASE. Ø40mm/1.6" (without mounting adapter). For normal stopping.			
LPC BL6643	Green	1	0.040
LPC BL6645	Yellow	1	0.040
LPC BL6646	Blue	1	0.040
For emergency stopping, ISO 13850 compliant.			
LPC BL6644	Red	10	0.040

Operational characteristics

- Any mounting position allowed
- Ambient conditions:
 - Operating temperature: -25...+70°C
 - Storage temperature: -40...+85°C
- Degree of protection:
 - Per IEC/EN: IP66, IP67 and IP69K
 - Per UL: Type 1, 2, 3R, 4, 4X, 12, 12K.

Materials

Polyamide.

Mechanical endurance

- Operating force: <0.5kg/1.1lb (actuator).
Mechanical life:
- Spring-return actuators: 5,000,000 cycles
 - Push-push actuators: 500,000 cycles
 - Spring-return mushroom-head actuator: 5,000,000 cycles
 - Latch mushroom-head actuators: 300,000 cycles.

Mounting adapter

See page 7-20.
Type: LPX AU120.
Actuators are installed through a Ø22mm/Ø0.87" drilling with a threaded fixing ring (Tmax = 2.3Nm/1.69lbf) also on the cover of LPZ control stations.
The mounting adapter directly snaps onto the actuator.

Contact elements for illuminated spring-return and mushroom-head latch actuators

See page 7-20, 7-23 or 7-24.

Type	Termination	
1NO	LPX C10	Screw
	LPX CF10	Faston
	LPX CS10	Spring clamp
1EM	LPX C10A	Screw
1NC	LPX C01	Screw
	LPX CF01	Faston
	LPX CS01	Spring clamp
1LB	LPX C01D	Screw

Base-mount types snap into LPZ control station base.
See example on page 7-27.

Up to 2 contacts can be fitted per control station actuator in addition to the LED element in the middle position.

1NO	LPX CB10	Screw
1NC	LPX CB01	Screw

Contact elements for illuminated push-push button actuators

See page 7-20.
Type: LPX C10A (1EM)
LPX C01 (1NC)

Contacts snap onto LPX AU120 adapter and also internally on the cover surface of LPZ control stations.
Up to 4 contacts can be fitted: 2 each on the left and right, one behind the other; up to 2 elements per control station actuator in addition to the LED element in the middle position.

LED light elements

See pages 7-22 to 24.

Certifications and compliance

Certifications obtained: UL Listed for USA and Canada, (cULus - File E93601), as Auxiliary Devices; EAC, CCC, RINA.
Compliant with standards: IEC/EN 60947-1, IEC/EN 60947-5-1, UL508, CSA C22.2 n° 14.

Double-touch actuators, spring return, white indicator



LPC BL71...



LPC BL72...

Order code	Colour	Symbol	Qty per pkg n°	Wt [kg]
------------	--------	--------	-------------------	------------

Two flush pushbuttons (without mounting adapter). Both spring return.

LPC BL7112	Black/Red	—	5	0.030
LPC BL7113	Green/Red	—	5	0.030
LPC BL7114	White/Black	—	1	0.030
LPC BL7122	Black/Red	I-O	5	0.030
LPC BL7123	Green/Red	I-O	5	0.030
LPC BL7124	White/Black	I-O	5	0.030
LPC BL7133	Green/Red	Start/Stop	5	0.030

One extended and one flush pushbuttons (without mounting adapter). Both spring return.

LPC BL7212	Black/Red	—	1	0.030
LPC BL7213	Green/Red	—	5	0.030
LPC BL7214	White/Black	—	1	0.030
LPC BL7222	Black/Red	I-O	1	0.030
LPC BL7223	Green/Red	I-O	5	0.030
LPC BL7224	White/Black	I-O	5	0.030
LPC BL7233	Green/Red	Start/Stop	5	0.030

Illuminated selector switch actuators



LPC SL1...

Order code	Colour	Type of positions	Qty per pkg. n°	Wt [kg]
------------	--------	-------------------	--------------------	------------

2 position (without mounting adapter).

LPC SL1203	Green	✓	10	0.025
LPC SL1204	Red		10	0.025
LPC SL1205	Yellow		10	0.025
LPC SL1206	Blue		10	0.025
LPC SL1208	White		10	0.025
LPC SL1213	Green	∇	10	0.025
LPC SL1214	Red		1	0.025
LPC SL1215	Yellow		1	0.025
LPC SL1216	Blue		1	0.025
LPC SL1218	White		10	0.025

3 position (without mounting adapter).

LPC SL1303	Green	∇	10	0.025
LPC SL1304	Red		10	0.025
LPC SL1305	Yellow		10	0.025
LPC SL1306	Blue		10	0.025
LPC SL1308	White		10	0.025
LPC SL1313	Green	∇	10	0.025
LPC SL1314	Red		1	0.025
LPC SL1315	Yellow		1	0.025
LPC SL1316	Blue		1	0.025
LPC SL1318	White		10	0.025
LPC SL1323	Green	∇	10	0.025
LPC SL1324	Red		1	0.025
LPC SL1325	Yellow		1	0.025
LPC SL1326	Blue		1	0.025
LPC SL1328	White		10	0.025
LPC SL1333	Green	∇	10	0.025
LPC SL1334	Red		1	0.025
LPC SL1335	Yellow		1	0.025
LPC SL1336	Blue		1	0.025
LPC SL1338	White		10	0.025

Contact activation of 2-position selector switch

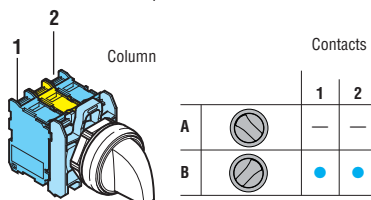

Contact activation of 3-position selector switch

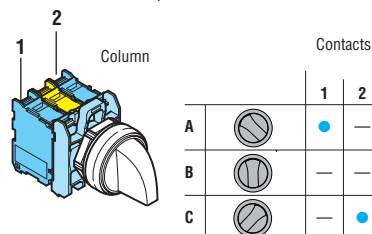

Operational characteristics

- Any mounting position allowed
- Ambient conditions:
 - Operating temperature: -25...+70°C
 - Storage temperature: -40...+85°C
- Degree of protection:
 - Per IEC/EN: IP66, IP67 and IP69K
 - Per UL: Type 1, 2, 3R, 4, 4X, 12, 12K.

Materials

Polyamide.

Mechanical endurance

- Operating force: <0.5kg/1.1lb (actuator).
Mechanical life:
- Double-touch: 1,000,000 cycles.
 - Selector switches: 1,000,000 cycles.

Mounting adapter

See page 7-20.

Type: LPX AU120.

Actuators are installed through a Ø22mm/Ø0.87" drilling with a threaded fixing ring (Tmax = 2.3Nm/1.69lbf) also on the cover of LPZ control stations.

The mounting adapter directly snaps onto the actuator.

Contact elements

See page 7-20, 7-23 or 7-24.

Type	Termination
------	-------------

Front-mount types snap onto LPX AU120 mounting adapter (to purchase separately).

For DOUBLE-TOUCH TYPES, up to 6 contacts can be fitted: 3 each on the left and right, one behind the other.

For SELECTOR SWITCHES, up to 4 contacts can be fitted: 2 each on the left and right, one behind the other.

They can also be fitted internally on the cover surface of LPZ control stations, up to 2 elements per actuator in addition to the LED element in the middle position.

1NO	LPX C10	Screw
	LPX CF10	Faston
	LPX CS10	Spring clamp
1EM	LPX C10A	Screw
1NC	LPX C01	Screw
	LPX CF01	Faston
	LPX CS01	Spring clamp
1LB	LPX C01D	Screw

Base-mount types snap into LPZ control station base.

See example on page 7-27.

Up to 2 contacts can be fitted per control station actuator in addition to the LED element in the middle position.

1NO	LPX CB10	Screw
1NC	LPX CB01	Screw

Selector switch type of positions

✓ Maintained position.

∇ Spring return position.

Selector switch rotation angles

2 position



3 position



LED light elements

See pages 7-22 to 7-24.

Certifications and compliance

Certifications obtained: UL Listed for USA and Canada, (cULus - File E93601), as Auxiliary Devices; EAC, CCC, RINA.

Compliant with standards: IEC/EN 60947-1, IEC/EN 60947-5-1, UL508, CSA C22.2 n° 14.

Pilot light heads



LPL...

Order code	Colour	Qty per pkg	Wt
		n°	[kg]
Without mounting adapter.			
LPL 3	Green	10	0.024
LPL 4	Red	10	0.024
LPL 5	Yellow	10	0.024
LPL 6	Blue	10	0.024
LPL 7	Transparent	10	0.024
LPL 1187	Transparent ⚡ Ⓢ	10	0.024

Ⓢ With symbol indicating dangerous voltage (IEC/EN 60417 5036-a).

Operational characteristics

- Any mounting position allowed
- Ambient conditions:
 - Operating temperature: -25...+70°C
 - Storage temperature: -40...+85°C
- Degree of protection:
 - Per IEC/EN: IP66, IP67 and IP69K
 - Per UL: Type 1, 2, 3R, 4, 4X, 12, 12K.

Materials

Polyamide.

Mounting adapter

See page 7-20.

Type: LPX AU120.

Pilot light heads are installed through a Ø22mm/Ø0.87" drilling with a threaded fixing ring (Tmax = 2.3Nm/ 1.69lbf) also on the cover of LPZ control stations, with LED element in central position.

The mounting adapter directly snaps onto the actuator.

LED light elements

See pages 7-20 to 7-24.

Certifications and compliance

Certifications obtained: UL Listed for USA and Canada, (cULus - File E93601), as Auxiliary Devices; EAC, CCC, RINA.

Compliant with standards: IEC/EN 60947-1, IEC/EN 60947-5-1, UL508, CSA C22.2 n° 14.

LED integrated monoblock pilot lights steady light



LPM...



Order code	Rated auxiliary supply voltage	LED colour	Qty per pkg	Wt
			n°	[kg]
LPM LA3	12VAC/DC	Green	10	0.021
LPM LA4		Red	10	0.021
LPM LA5		Yellow	10	0.021
LPM LA6		Blue	10	0.021
LPM LA7		Transparent	10	0.021
LPM LB3	24VAC/DC	Green	10	0.021
LPM LB4		Red	10	0.021
LPM LB5		Yellow	10	0.021
LPM LB6		Blue	10	0.021
LPM LB7		Transparent	10	0.021
LPM LD3	48VAC/DC	Green	10	0.021
LPM LD4		Red	10	0.021
LPM LD5		Yellow	10	0.021
LPM LD6		Blue	10	0.021
LPM LD7		Transparent	10	0.021
LPM LE3	110VAC	Green	10	0.024
LPM LE4		Red	10	0.024
LPM LE5		Yellow	10	0.024
LPM LE6		Blue	10	0.024
LPM LE7		Transparent	10	0.024
LPM LM3	230VAC	Green	10	0.024
LPM LM4		Red	10	0.024
LPM LM5		Yellow	10	0.024
LPM LM6		Blue	10	0.024
LPM LM7		Transparent	10	0.024

Operational characteristics

- Nominal frequency: 50-60Hz
- Supply voltage: 12VAC/DC, 24VAC/DC, 48VAC/DC, 110VAC, 230VAC (-15%...+10% Ue)
- Consumption: ≤20mA
- Installed through a Ø22mm/Ø0.87" drilling with a threaded fixing ring (Tmax = 2.3Nm/1.69lbf) also on cover of LPZ control stations
- Electrical life: >30,000 hours
- Screw termination
- Side cable entry
- Maximum tightening torque: 0.8Nm
- Ambient conditions:
 - Operating temperature: -5...+70°C
- Degree of protection:
 - per IEC/EN: IP66, IP67 and IP69K on front; IP20 at rear
 - per UL: Type 1, 2, 3R, 4, 4X, 12, 12K on front.

Materials

Polyamide.

Maximum conductor cross section

1 or 21.5mm² or AWG16 cables.

Wiring diagram



Certifications and compliance

Certifications obtained: cULus (pending), EAC, CCC (pending).

Compliant with standards: IEC/EN 60947-1, IEC/EN 60947-5-1, UL508, CSA C22.2 n° 14.

Monoblock potentiometers



LPC PA...



Order code	Resistance value	Qty per pkg.	Wt
		n°	[kg]
LPC PA001	1kΩ	10	0.040
LPC PA002	2.5kΩ	10	0.040
LPC PA005	5kΩ	10	0.040
LPC PA010	10kΩ	10	0.040
LPC PA050	50kΩ	10	0.040
LPC PA100	100kΩ	10	0.040
LPC PA500	500kΩ	10	0.040

General characteristics

Monoblock potentiometers are typically used for regulating the parameters of many devices (e.g. the speed of the electric motors through static converters).

The monoblock body design permits direct use of the potentiometer by panel fitting with fixing ring and subsequent tightening of cables into the built-in terminal block.

The potentiometer is made with Cermet technology, which ensures stable, constant resistance values over time. The, UL-certified, range is made for resistance values from 1 to 500kΩ. All potentiometers are IP66, IP67, IP69K and UL Type 4X, which means that they can be used in demanding ambient conditions.

Operational characteristics

- Rated insulation voltage U_i : 250VAC
- Impulse withstand voltage U_{imp} : 4kV
- Potentiometer included in the product
- Monoblock body with 1-turn graduated scale
- Any fitting position permitted
- Installed through a Ø22mm/Ø0.87" drilling with a threaded fixing ring ($T_{max} = 2.3Nm/1.69lbft$) also on the cover of LPZ control stations
- Resistive material: cermet
- Operation: linear
- Resistance tolerance: $\pm 10\%$
- Max. power: 1W (70°C)
- Mechanical endurance: 25,000 operations
- Mechanical travel: 290°
- Side cable entry
- Ambient conditions:
 - Operating temperature: -25...+70°C
 - Storage temperature: -40...+85°C
- Degree of protection:
 - Per IEC/EN: IP66, IP67 and IP69K on front
 - Per IEC/EN: IP20 at rear
 - Per UL: Type 1, 2, 3R, 4, 4X, 12, 12K on front.

Materials

Polyamide.

Maximum conductor cross section

Screw terminal connections with three separate connections:

- Min. cable 0.5mm² / AWG24
- Max. cable 2.5mm² / AWG14
- Maximum tightening torque: 0.5Nm/0.37lbft
- Flat-head screwdriver: 0.6x3.5mm/0.02x0.14"

Certifications and compliance

Certifications obtained: cULus, EAC, CCC (pending), RINA (pending).

Compliant with standards: IEC/EN 60947-1, IEC/EN 60947-5-1, UL508, CSA C22.2 n° 14.

Monoblock buzzers



LPC ZS...



LPC ZS...IP



Order code	Voltage	Sound intensity at 2800Hz	Qty per pkg.	Wt
	[V]	[dB/10cm]	n°	[kg]
Continuous or pulse tone, IP40 version.				
LPC ZSA	9...15VAC/DC	90	1	0.020
LPC ZSB	18...30VAC/DC	90	1	0.020
LPC ZSE	85...140VAC/DC	90	1	0.020
LPC ZSM	185...265VAC/DC	90	1	0.020
Continuous or pulse tone, IP66, IP67, IP69K, UL Type 4X version.				
LPC ZSAIP	9...15VAC/DC	80	1	0.020
LPC ZSBIP	18...30VAC/DC	80	1	0.020
LPC ZSEIP	85...140VAC/DC	80	1	0.020
LPC ZSMIP	185...265VAC/DC	80	1	0.020

Pulse-tone sound graph

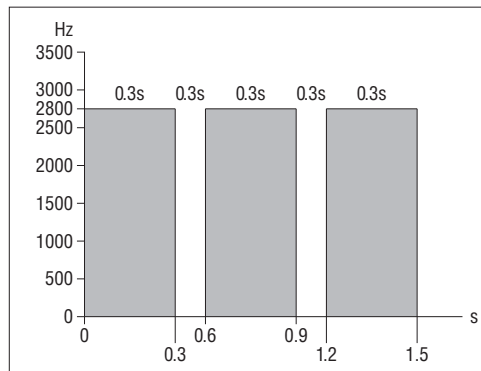

General characteristics

Monoblock buzzers are used as sound indicators in automation systems and on-board machinery in the production processes. Long life, low consumption values, compact size and the use of materials, in accordance with the North American market, are the main features of this product.

Operational characteristics

- Rated frequency: 50...60Hz
- Supply voltage: 9...15VAC/DC, 18...30VAC/DC, 85...140VAC/DC, 185...265VAC/DC
- Maximum absorption: 20mA-0.30W (type 9...15VAC/DC), 15mA-0.40W (type 18...30VAC/DC), 5.5mA-0.80W (type 85...140VAC/DC), 3.5mA-0.95W (type 185...265VAC/DC)
- Minimum activation voltage: >4V (type 9...15VAC/DC), >8V (type 18...30VAC/DC), >15V (type 85...140VAC/DC), >25V (type 185...265VAC/DC)
- Impulse withstand voltage Uimp: 4kV
- Installed through a Ø22mm/Ø0.87" drilling with a threaded fixing ring (Tmax = 2.3Nm/1.69lbf) also on the cover of LPZ control stations
- Service life: 30,000 hours (permanently powered)
- Side cable entry
- Ambient conditions:
 - Operating temperature: -25...+70°C
 - Storage temperature: -40...+85°C
- Degree of protection (type LPC ZS...IP):
 - per IEC/EN: IP66, IP67, IP69K on front and IP20 at rear
 - per UL: Type 1, 2, 3R, 4, 4X, 12, 12K on front.

Materials

Polyamide.

Maximum conductor cross section

Screw terminal connections with three separate connections:

- Min. cable 0.5mm² / AWG24
- Max. cable 2.5mm² / AWG14
- Maximum tightening torque: 0.5Nm/0.37lbf
- Flat-head screwdriver: 0.6x3.5mm/0.02x0.14"

Certifications and compliance

Certifications obtained: cULus, EAC, CCC (pending), RINA (pending).

Compliant with standards: IEC/EN 60947-1, IEC/EN 60947-5-1, UL508, CSA C22.2 n° 14.

USB and RJ45 communication interfaces



LPC D01



Order code	Description	Qty per pkg.	Wt
		n°	[kg]
LPC D01	USB interface, A/A female type connection	1	0.018
LPC D03	USB interface, A/B female type connection	1	0.018
LPC D05	USB interface, B/A female type connection	1	0.018
LPC D06	RJ45 interface, Ethernet connection type	1	0.026



LPC D03



LPC D05

General characteristics

USB and RJ45 communication interface connectors are used in industrial environments, which in recent years have seen an increase in the number of connections between machines, production lines, equipment and measuring instruments. These interfaces provide the transmission of data in both directions between the various devices.

Operational characteristics

- Rated insulation voltage for LPCD01, LPCD03, LPCD05: 5VAC/DC
- Rated insulation voltage for LPCD06: 24VAC
- Interface mechanical endurance: ≥750 insertions
- Installed through a Ø22mm/Ø0.87" drilling with a threaded fixing ring (Tmax = 2.3Nm/1.69lbf) also on the cover of LPZ control stations
- Transmission characteristics for LPCD01, D03, D05: 5Gbps (625MB/sec)
- Transmission characteristics for LPCD06: 10 Gigabit Ethernet IEEE 802.3an-2006
- Rated current for LPCD01, LPCD03, LPCD05: 1.8A
- Rated current for LPCD06: 1.5A
- Insulation resistance: ≥100MΩm
- Contact resistance for LPCD01, LPCD03, LPCD05: ≤30mΩm
- Contact resistance for LPCD06: ≤40mΩm
- USB connector class: 3.0 (backward compatible with USB class 2.0)
- Ambient conditions:
 - Operating temperature: -25...+70°C
 - Storage temperature: -40...+85°C
- Degree of protection:
 - Per IEC/EN: IP65 on front (with cap mounted)
 - Per IEC/EN: IP20 at rear
 - Per UL: Type 1, 2, 3R, 4, 4X, 12, 12K on front (with cap mounted)

Materials

Polyamide.

Certifications and compliance

Certifications obtained: cULus, EAC, CCC (pending), RINA (pending).

Compliant with standards: IEC/EN 60947-1, IEC/EN 60947-5-1, UL508, CSA C22.2 n° 14.

Accessories and spare parts



LPX A130



LPX A140

7



LPX AU00



LPX P01



LPX B0



LPX B104



LPX B203



LPX BL105

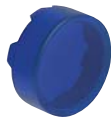

LPX BL206

Order code	Description	Qty per pkg. n°	Wt [kg]
LPX A127	Transparent diffuser for double-touch buttons	10	0.001
LPX A130	Threaded plug for unused drilled holes (grey)	10	0.007
LPX A140	Action plug for centre contact	50	0.001
LPX A150	Rod for mechanical reset button (l=150mm)	10	0.006
LPX A170	Spare standard key set for selector switches or mushroom-head buttons, key code n° 455	10	0.008
LPX A170R	Spare key set for selector switches or mushroom head buttons, LPC...R type	1	0.008
LPX AU00	Threaded ring for actuator fixing	20	0.002
LPX P01	M20 cable gland with threaded ring for LPZ control stations	50	0.012
LPX B0	Flush-extended spring return actuator with no cap	10	0.013
LPX B3	Shrouded spring return actuator with no cap	10	0.014
LPX Q0	Flush-extended push-push actuator with no cap	10	0.013
LPX QL0	Illuminated flush-extended push-push actuator with no lens	10	0.013

Flush cap for spring-return actuators.

LPX B102	Black	10	0.002
LPX B103	Green	10	0.002
LPX B104	Red	10	0.002
LPX B105	Yellow	10	0.002
LPX B106	Blue	10	0.002
LPX B108	White	10	0.002

Extended cap for spring-return actuators.

LPX B202	Black	10	0.003
LPX B203	Green	10	0.003
LPX B204	Red	10	0.003
LPX B205	Yellow	10	0.003
LPX B206	Blue	10	0.003
LPX B208	White	10	0.003

Flush lens for illuminated spring-return actuators .

LPX BL103	Green	10	0.002
LPX BL104	Red	10	0.002
LPX BL105	Yellow	10	0.002
LPX BL106	Blue	10	0.002
LPX BL107	Transparent	10	0.002

Extended lens for illuminated spring-return actuators.

LPX BL203	Green	10	0.003
LPX BL204	Red	10	0.003
LPX BL205	Yellow	10	0.003
LPX BL206	Blue	10	0.003
LPX BL207	Transparent	10	0.003

❶ Versions with different key code. Complete with the numeric code of the key. The following versions are available: 421E, 458A, 520E, 3131A, 3433E
Example of complete code: LPX A170R421E.

Accessories and spare parts



LPX AU100



LPX AU105



LPX AU108
LPX AU109



LPX AU158



8 LM2T A185



LPX AU159



LPX DIN

Order code	Description	Qty per pkg. n°	Wt [kg]
LPX AU100	Label holder for engraved plastic LPX AU109 label	50	0.001
LPX AU109	Engravable silver plastic label to use with LPX AU100 holder	50	0.002
LPX AU105	Label holder for engraved plastic LPX AU108 label	50	0.003
LPX AU108	Engravable silver plastic label to use with LPX AU105 holder	50	0.002
LPX AU13 ^②	Rubber boot for flush button LPC B1/BL1/R1...	10	0.006
LPX AU14 ^②	Rubber boot for buttons LPC B2/3..., LPC BL2... and LPC R2...	10	0.009
LPX AU157	Rubber boot for double and triple-touch buttons, transparent	10	0.007
LPX AU167 ^③	Rubber boot for mushroom head buttons, LPC B63/B66/B67/BL66... transparent	10	0.012
LPX AU158 ^④	Padlockable protection, Ø5-8mm locks or buttons LPC B66/B67/B68/BL664...; for LPC B634... Ø5-6mm/0.2-0.24" locks only.	10	0.005
LPX AU159 ^④	Shroud for buttons LPC B63..., LPC B66/67/68/BL666...	10	0.010
LPX DIN	Adapter for mounting LPC... buttons on DIN rail 35mm/1.38" wide (2 modules)	10	0.008

new

new

Other accessories

8 LM2T A161	Ø30mm/1.2" hole size adapter set for 22mm/0.87" (use 2 per hole)	10	0.002
8 LM2T A185	Yellow selector protection shroud for knob type only	10	0.004
8 LM2T A200	Socket spanner/wrench for fixing ring fitting, metal	1	0.184

① For flush and extended push buttons, complete the order code by adding the digit of the required colour: 2 (black); 3 (green); 4 (red); 5 (yellow); 6 (blue); 7 (transparent); 8 (white). For illuminated push buttons, add only digit 7 (transparent).

② Cannot be used when LPX AU100 or LPX AU105 is fitted.

③ Cannot be used when LPX AU158 is fitted.

④ Cannot be used when LPX AU167 is fitted.

Labels with text for LPX AU100 legend holder

STOP

8 LM2T AGB230

7

Order code	Text	Qty per pkg n°	Wt [kg]
General use.			
8 LM2T AU206	Blank for writing	50	0.001
8 LM2T AU207	Sheet with 108 labels for laser printing ^①	1 ^②	0.005
8 LM2T AU208 ^③	Sheet with 108 customized text ^①	1 ^②	0.005
8 LM2T AGB210	LATCH	50	0.001
8 LM2T AGB211	OPEN	50	0.001
8 LM2T AGB212	STOP	50	0.001
8 LM2T AGB213	GENERAL STOP	50	0.001
8 LM2T AGB214	STOP RESET	50	0.001
8 LM2T AGB215	FORWARD	50	0.001
8 LM2T AGB216	CLOSE	50	0.001
8 LM2T AGB217	RIGHT	50	0.001
8 LM2T AGB218	LOWER	50	0.001
8 LM2T AGB219	DEACTIVATED	50	0.001
8 LM2T AGB220	EMERGENCY	50	0.001
8 LM2T AGB221	OFF	50	0.001
8 LM2T AGB222	REVERSE	50	0.001
8 LM2T AGB223	ON	50	0.001
8 LM2T AGB237	TRIP	50	0.001
8 LM2T AGB224	SLOW	50	0.001
8 LM2T AGB225	START	50	0.001
8 LM2T AGB226	RESET	50	0.001
8 LM2T AGB226	RESET	50	0.001
8 LM2T AGB227	RAISE	50	0.001
8 LM2T AGB228	LEFT	50	0.001
8 LM2T AGB229	POWER ON	50	0.001
8 LM2T AGB225	START	50	0.001
8 LM2T AGB230	STOP	50	0.001
8 LM2T AGB214	STOP-RESET	50	0.001
8 LM2T AGB231	FAST	50	0.001
For selector switches.			
8 LM2T AI232	ARR-MAR	50	0.001
8 LM2T AI233	AUTO-MAN	50	0.001
8 LM2T AI234	AUTO-O-MAN	50	0.001
8 LM2T AI242	MAN-O-AUTO	50	0.001
8 LM2T AI235	FWD-O-REV	50	0.001
8 LM2T AI236	ON - OFF.	50	0.001
8 LM2T AI241	MAN-AUTO	50	0.001
8 LM2T AGB232	STOP-START	50	0.001
8 LM2T AGB236	OFF-ON	50	0.001
International labels for push-buttons.			
8 LM2T AU200	O	50	0.001
8 LM2T AU201	I	50	0.001
8 LM2T AU202	II	50	0.001
International labels for selector switches.			
8 LM2T AU203	O-I	50	0.001
8 LM2T AU204	I-II	50	0.001
8 LM2T AU205	I-O-II	50	0.001

① Recommended use with LPX AU109 label.

② Sheet with 108 adhesive labels.

③ Complete code with required label text.

General characteristics

The labels have indelible scratch-proof black lettering on metalised grey polycarbonate background (adhesive).

Special versions

Labels in different languages are available.

Consult Customer Service; see contact details on inside front cover.

Plastic disk for mushroom head pushbuttons



LPX AU113



LPX AU115



LPX AU110

Order code	Text	Qty per pkg. n°	Wt [kg]
LPX AU112	EMERGENZA ARRESTO Ø90mm/3.5"	10	0.005
LPX AU114	EMERGENZA ARRESTO Ø60mm/2.4"	10	0.003
LPX AU113	EMERGENCY STOP Ø90mm/3.5"	10	0.005
LPX AU115	EMERGENCY STOP Ø60mm/2.4"	10	0.003
LPX AU118	ARRET D'URGENCE / NOT-AUS/ PARO EMERGENCIA Ø60mm/2.4"	10	0.003
LPX AU110	Adhesive label EMERGENCY STOP (34.5x65mm/1.36x2.56") for LPC B63/663/664/ 67/68/BL66...buttons	12	0.001

General characteristics

The disks are made of non-adhesive plastic.
Plastic disks cannot be used with LPX AU158 and LPX AU159 protection.

Mounting adapter



LPX AU120

Order code	Description	Qty per pkg	Wt
		n°	[kg]
LPX AU120	Mounting adapter	10	0.019

Rear view
(reference for element installation)

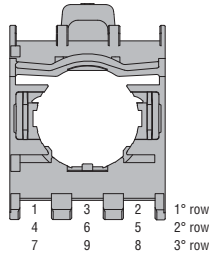

Contact elements

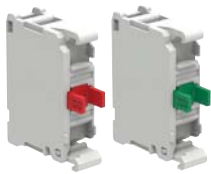

LPX C...

Order code	Function	Qty per pkg	Wt
		n°	[kg]
LPX C10⊕	NO⊕	10	0.011
LPX C10A	EM⊕	10	0.011
LPX C01⊖	NC⊖	10	0.011
LPX C01D⊕⊖	LB⊕⊖	10	0.011

Screw termination.
Without mounting adapter.



LPX C01SM

LPX C02SM

Screw termination. Without mounting adapter.
Auto-monitor contact elements for non-illuminated latch mushroom-head pushbuttons.

LPX C01SM⊕⊖	1NC⊕⊖	1	0.022
LPX C02SM⊕⊖	2NC⊕⊖	1	0.033

Screw termination.
With mounting adapter.

LPX E10⊕	NO⊕	10	0.029
LPX E01⊖	NC⊖	10	0.029



LPX E...

Faston termination.
Without mounting adapter.

LPX CF10⊕	NO⊕	10	0.012
LPX CF01⊖	NC⊖	10	0.012



LPX CF01

LPX CF10

⊕ Use LPX C10A (EM) or LPX C01 (NC) type only with push-push actuators.

Not suitable for push-push actuators.

⊖ Normally open contact with early-make operation and suitable for push-push actuators.

⊕ Direct (positive) opening action ⊖ in accordance with IEC/EN 60947-5-1.

⊖ Normally closed contact with late break operation.

Drillings - Minimum recommended distances

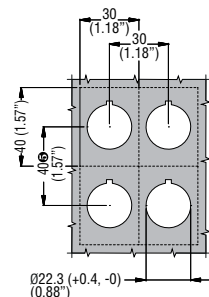

⊖ When using Faston, pitch is 85mm/3.35" minimum.

Operational characteristics

- Any mounting position allowed.
- All LPX C... types snap onto LPX AU120 mounting adapter:
 - See the combinations given under "Contact elements" in the right-hand column for each type of pushbutton and selector switch.
 - A maximum of 3 contacts or 2 contacts and 1 LED element (LPX L... mounted in the middle position) can be fixed internally on the cover surface of LPZ control stations.
- A maximum of 2 LPX C...SM contacts can be installed on LPX AU120 adapter exclusively on non-illuminated mushroom-head latch actuators:
 - In pos. 1-3 (on the left side only of LPX AU120; refer to REAR VIEW drawing), one only LPX C01SM or LPX C02SM element can be fitted.
 - One extra LPX...SM can be installed in pos. 4-6 (stacked behind the LPX...SM on the LPX AU120)
 - With LPX C01SM, a maximum of two contacts LPX C0... or LPX C1... can be fitted on the right side in LPX AU120 pos. 2 and 5, one behind the other.
 - On the internal surface of LPZ control station covers, one only LPX C01SM or LPX C02SM contact can be mounted on LPX AU120 pos. 1 (on the left). With LPX C01SM, one extra element LPX C0... or LPX C1... can be fitted on the right (LPX AU120 pos. 2).
 - No LED element can be used with LPX C...SM types.
- Maximum tightening torque for screw terminals: 1Nm/0.74lbf
- Ambient conditions:
 - Operating temperature: -25...+70°C
 - Storage temperature: -40...+85°C
- Degree of protection:
 - IP20 for screw termination
 - IP00 for Faston termination.

General characteristics of contact elements

Wiping effect, dual scraping-oscillating action
IEC rated insulation voltage: 690V
IEC rated thermal current Ith: 10A
Conductivity: 5V 1mA
UL/CSA and IEC/EN 60947-5-1 designation: A600 Q600.

IEC/EN operational characteristics in AC15 category:

[V]	12	24	48	120	240	400	480	500	600
[A]	6	6	6	6	3	1.9	1.5	1.4	1.2

IEC/EN operational characteristics in DC13 category:

[V]	12	24	48	125	250	440	500	600
[A]	3	3	1.5	0.55	0.27	0.15	0.13	0.1

Short-circuit protection fuse: max calibre: 10A gG/SC.

Contact resistance: ≤20mΩ.

Terminals: Clamp screw with washer.
Faston 1x6.35mm(0.25") or 2x2.8mm(0.11").

Stroke of contact elements

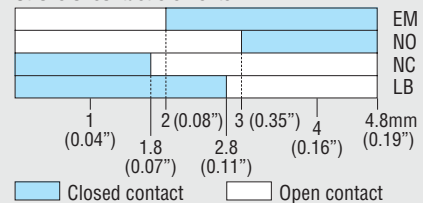

Maximum conductor cross section for screw terminals
1 or 2 2.5mm² or AWG14 cables.

Mechanical and electrical endurance

Operating force: ≤0.5kg/1.1lb (auxiliary contacts).
Electrical life: 1,000,000 cycles for LPXC10/01/E10/01, LPX C01SM/02SM, LPXCF10/01; 600,000 cycles for LPXC10A/01D.

Certifications and compliance

Certifications obtained: UL Listed for USA and Canada, (cULus - File E93601), as Auxiliary Devices; EAC, CCC, RINA.

Compliant with standard: IEC/EN 60947-1, IEC/EN 60947-5-1, UL508, CSA C22.2 n° 14.

Test elements for steady-light LED elements



LPX T...

Order code	Description	Qty per pkg	Wt
		n°	[kg]
LPX T100 ①②	Use with LED elements in AC/DC, types LPX LE... (all), LPX LFB..., LPX LPB and LPX LPSB...	10	0.011
LPX T101 ②	Use with LED elements at 85-140VAC for types LPX LFE... LPX LPE... and LPX LPSE...	10	0.011
LPX T102 ②	Use with LED elements at 185-265VAC for types LPX LFM..., LPX LPM... and LPX LPSM...	10	0.011

- ① Whenever test circuits include illuminated actuators connected with paralleled load, use two LPX T100 for each LED element. Refer to the wiring diagram below or online in the Downloads section at www.LovatoElectric.com
- ② With DC supply only for LPX T100 type, the LED element works at full voltage and brightness while with AC supply for all LPX T... types, the LED element works at half voltage with reduced brightness level.

For LPX T100 test element

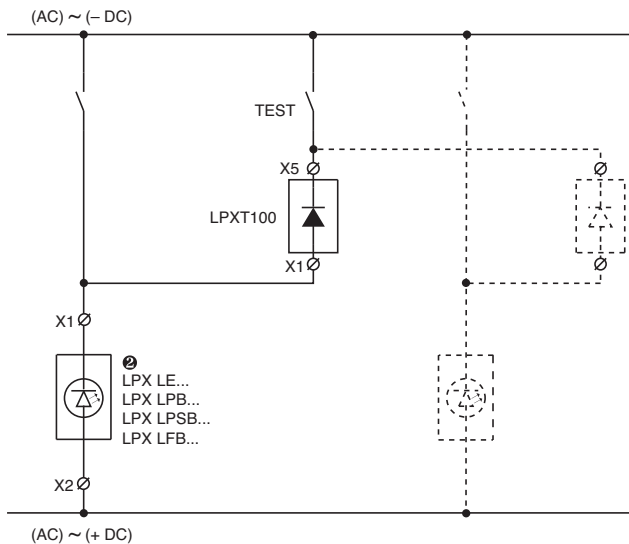

For LPX T101 and LPX T102 test elements

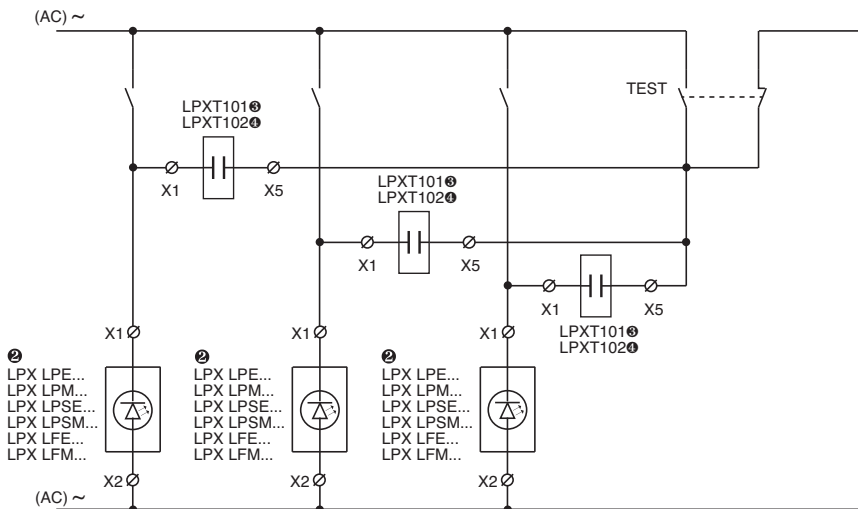

- ③ Use with LPX LFE..., LPX LPE... or LPX LPSE... type.
- ④ Use with LPX LFM..., LPX LPM... or LPX LPSM... type.

Operational characteristics

- Supply voltage:
 - LPX T100 test element:
 - 12...30VAC/DC for LPX LEB/LFB/LPB/LPSB...
 - 85...140VAC/DC for LPX LEE...
 - 185...265VAC/DC for LPX LEM...
 - LPX T101 test element: 85-140VAC
 - LPX T102 test element: 185-265VAC
- For use with LED elements LPX LPBB/LPBE/LPBM... types, consult Customer Service; see contact details on inside front cover
- Electrical life: 100,000 hours
- Any mounting position allowed
- Snap onto LPX AU120 mounting adapter beside the LED element or stacked behind contact elements; also internally on the LPZ control station cover
- Maximum tightening torque for screw terminals: 1Nm/0.74lbf
- Ambient conditions:
 - Operating temperature: -25...+70°C
 - Storage temperature: -40...+85°C
- Degree of protection: IP20.

Mounting adapter

Type: LPX AU120. See page 7-20.
The mounting adapter directly snaps onto the actuator fixed to the mounting surface.

Maximum conductor cross section

1 or 2 2.5mm² or AWG 12 cables.

Wiring Diagram

For LPX T100



For LPX T101 - LPX T102

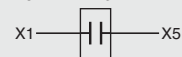

Certifications and compliance

Certifications obtained: UL Listed for USA and Canada, (cULus - File E93601), as Auxiliary Devices; EAC, CCC, RINA.

Compliant with standards: IEC/EN 60947-1, IEC/EN 60947-5-1, UL508, CSA C22.2 n° 14.

LED elements steady light



LPX LP...

7

Total protection against overvoltages and stray currents in wiring, to reduce flickering phenomenon and withstand vibrations.

Order code	Rated supply voltage	LED colour	Qty per pkg.	Wt
	[V]		n°	[kg]

Steady light, screw termination.
Supplied without mounting adapter.

LPX LP B3	12...30V AC/DC	Green	10	0.016
LPX LP B4		Red	10	0.016
LPX LP B5		Yellow	10	0.016
LPX LP B6		Blue	10	0.016
LPX LP B8		White	10	0.016
LPX LP E3	85...140V AC	Green	10	0.016
LPX LP E4		Red	10	0.016
LPX LP E5		Yellow	10	0.016
LPX LP E6		Blue	10	0.016
LPX LP E8		White	10	0.016
LPX LP M3	185...265V AC	Green	10	0.016
LPX LP M4		Red	10	0.016
LPX LP M5		Yellow	10	0.016
LPX LP M6		Blue	10	0.016
LPX LP M8		White	10	0.016

Order code	Rated supply voltage	LED colour	Qty per pkg.	Wt
	[V]		n°	[kg]

Steady light, screw termination.
Supplied without mounting adapter.

LPX LE B3	12...30V AC/DC	Green	10	0.016
LPX LE B4		Red	10	0.016
LPX LE B5		Yellow	10	0.016
LPX LE B6		Blue	10	0.016
LPX LE B8		White	10	0.016
LPX LE E3	85...140V AC/DC	Green	10	0.016
LPX LE E4		Red	10	0.016
LPX LE E5		Yellow	10	0.016
LPX LE E6		Blue	10	0.016
LPX LE E8		White	10	0.016
LPX LE M3	185...265V AC/DC	Green	10	0.016
LPX LE M4		Red	10	0.016
LPX LE M5		Yellow	10	0.016
LPX LE M6		Blue	10	0.016
LPX LE M8		White	10	0.016



LPX LE...

Simple protection against overvoltages and to withstand vibrations.

LED elements flashing light



LPX LF...

Total protection against overvoltages and stray currents in wiring, to reduce flickering phenomenon and withstand vibrations.

Order code	Rated supply voltage	LED colour	Qty per pkg.	Wt
	[V]		n°	[kg]

Flashing light, screw termination.
Supplied without mounting adapter.

LPX LF B3	18...30V AC/DC	Green	10	0.016
LPX LF B4		Red	10	0.016
LPX LF B5		Yellow	10	0.016
LPX LF B6		Blue	10	0.016
LPX LF B8		White	10	0.016
LPX LF E3	85...140V AC	Green	10	0.016
LPX LF E4		Red	10	0.016
LPX LF E5		Yellow	10	0.016
LPX LF E6		Blue	10	0.016
LPX LF E8		White	10	0.016
LPX LF M3	185...265V AC	Green	10	0.016
LPX LF M4		Red	10	0.016
LPX LF M5		Yellow	10	0.016
LPX LF M6		Blue	10	0.016
LPX LF M8		White	10	0.016

Operational characteristics

- Rated frequency: 50-60Hz
- Auxiliary supply voltage:
 - LPX LP... with steady light: 12...30VAC/DC; 85...140VAC; 185...265VAC
 - LPX LE... with steady light: 12...30VAC/DC; 85...140VAC/DC; 185...265VAC/DC
 - LPX LF... flashing light: 18...30VAC/DC; 85...140VAC; 185...265VAC
- Maximum consumption for:
 - LPX LP... steady light and LPX LF... flashing light: 17mA-0.50W (12...30VAC/DC); 20mA-0.40W (85...140VAC); 18mA-0.55W (185...265VAC)
 - LPX LE... steady light: 11mA-0.33W (12...30VAC/DC); 5mA-0.72W (85...140VAC/DC); 3mA-0.67W (185...265VAC/DC)
- Total protection for LPX LP... and LPX LF... types:
 - Against overvoltages
 - Against stray currents in wiring
 - To reduce flickering phenomenon
 - To withstand vibrations
- Minimum activation voltage:
 - LPX LP... steady light: 4V-1mA (12...30VAC/DC); 30V-4mA (85...140VAC); 55V-4mA (185...265VAC)
 - LPX LE... steady light: 4V-0.5mA (12...30VAC/DC); 15V-0.4mA (85...140VAC/DC); 35V-0.3mA (185...265VAC/DC)
 - LPX LF... flashing light: 5V-1.5mA (18...30VAC/DC); 13V-1.5mA (85...140VAC); 25V-1.5mA (185...265VAC)
- Simple protection for LPX LE... types
 - Against overvoltages
 - To withstand vibrations
- Electrical life: 100,000 hours
- Snap onto LPX AU120 mounting adapter in the middle position for each illuminated actuator, also internally on the LPZ control station cover
- No other element can be stacked behind LED elements
- Any mounting position allowed
- Maximum tightening torque: 1Nm/0.74lbf
- Ambient conditions:
 - Operating temperature: -25...+70°C (-25...+60°C for LPX LE...)
 - Storage temperature: -40...+85°C
- Degree of protection: IP20.

Mounting adapter

See page 7-20. Type: LPX AU120.
The mounting adapter directly snaps onto the actuator fixed to the mounting surface.

Maximum conductor cross section

1 or 2 2.5mm² or AWG12 cables.

Wiring diagram



Certifications and compliance

Certifications obtained: UL Listed for USA and Canada, (cULus - File E93601), as Auxiliary Devices; EAC, CCC, RINA.

Compliant with standards: IEC/EN 60947-1, IEC/EN 60947-5-1, UL508, CSA C22.2 n° 14.

Contact elements with spring-clamp terminals



LPX CS01 LPX CS10

Order code	Function	Qty per pkg	Wt
		n°	[kg]

Spring-clamp termination.
Without mounting adapter.

LPX CS10		10	0.010
LPX CS01		10	0.010

① Not suitable for push-push actuators.

② Direct (positive) opening action ⊖ in accordance with IEC/EN 60947-5-1

LED elements steady light with spring-clamp terminals



LPX LPS...

Order code	Rated supply voltage	LED colour	Qty per pkg	Wt
	[V]		n°	[kg]

Steady light, with spring-clamp termination.
Without mounting adapter.

LPX LPS B3	12...30VAC/DC	Green	10	0.015
LPX LPS B4		Red	10	0.015
LPX LPS B5		Yellow	10	0.015
LPX LPS B6		Blue	10	0.015
LPX LPS B8		White	10	0.015
LPX LPS E3	85...140VAC	Green	10	0.015
LPX LPS E4		Red	10	0.015
LPX LPS E5		Yellow	10	0.015
LPX LPS E6		Blue	10	0.015
LPX LPS E8		White	10	0.015
LPX LPS M3	185...265VAC	Green	10	0.015
LPX LPS M4		Red	10	0.015
LPX LPS M5		Yellow	10	0.015
LPX LPS M6		Blue	10	0.015
LPX LPS M8		White	10	0.015

Total protection against overvoltages and stray currents in wiring, to reduce flickering phenomenon and withstand vibrations.

Drillings - Minimum recommended distances

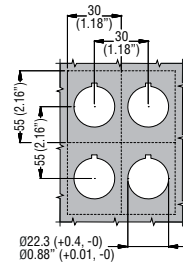

Push-in wiring technology for rigid cables or with ferrules only - no screwdriver needed
Cable retaining force guaranteed over time even in presence of vibrations and/or impacts

Push-in technology

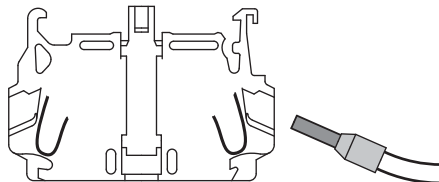

Wiring with flat-blade screwdriver
(for flexible bare cable without terminal)

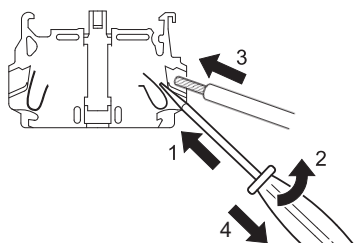

Cable removal
(always using flat-blade screwdriver)

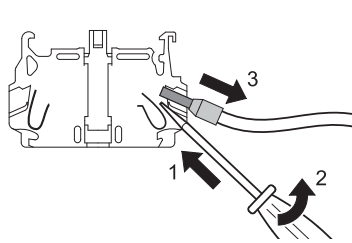

Operational characteristics

- Any mounting position allowed
- Elements snap onto LPX AU120 adapter, also internally on LPZ control station cover with maximum of 3 LPX CS... contact or 2 LPX CS... contact and 1 LPX LPS... LED elements (in middle position) per actuator
- No other element can be stacked behind LED elements
- See the combinations given under "Contact elements" in the right-hand column for each type of pushbutton and selector switch
- Suitable for applications with vibration and/or impact work conditions; cable retaining force guaranteed over time in these conditions
- For use with the test elements, see page 7-20
- Wiring also possible after installation with stacked contacts
- Ambient conditions:
 - Operating temperature: -25...+70°C
 - Storage temperature: -40...+85°C
- Degree of protection: IP20.

Mounting adapter

See page 7-20.

Type : LPX AU120.

The mounting adapter directly snaps onto the actuator fixed to the mounting surface.

General characteristics

CONTACT ELEMENTS

Wiping action and dual scraping-oscillating effect

IEC rated insulation voltage: 690V

IEC rated thermal current Ith: 10A

Conductivity: 1mA 5V

UL/CSA and IEC/EN 60947-5-1 designation: A600 Q600.

IEC/EN operational characteristics in AC15 category:

[V]	12	24	48	120	240	400	480	500	600
-----	----	----	----	-----	-----	-----	-----	-----	-----

[A]	6	6	6	6	3	1.9	1.5	1.4	1.2
-----	---	---	---	---	---	-----	-----	-----	-----

IEC/EN operational characteristics in DC13 category:

[V]	12	24	48	125	250	440	500	600
-----	----	----	----	-----	-----	-----	-----	-----

[A]	3	3	1.5	0.55	0.27	0.15	0.13	0.1
-----	---	---	-----	------	------	------	------	-----

Short circuit protection fuse: max calibre: 10A gG/SC.

Contact resistance: ≤20mΩ.

Terminals: Spring clamps.

Stroke of contact elements

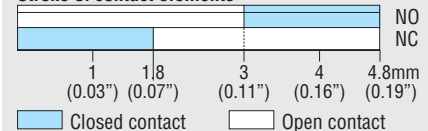

Mechanical and electrical endurance of contact elements

Opening force: ≤0,5kg/1.1lb

Electrical life: 1.000.000 cycles for LPX CS10 and LPX CS01.

LED ELEMENTS

- Rated frequency: 50-60Hz

- Supply voltage:

12...30VAC/DC; 85...140VAC; 185...265VAC

- Maximum consumption: 17mA-0.50W (12...30VAC/DC);

20mA-0.40W (85...140VAC);

18mA-0.55W (185...265VAC)

- Total protection:

• Against overvoltages

• Against stray currents in wiring

• To reduce flickering phenomenon

• To withstand vibrations

- Minimum activation voltage:

4V-1mA (12...30VAC/DC); 30V-4mA (85...140VAC);

55V-4mA (185...265VAC)

- Electrical life: 100,000 hours.

Wiring diagram for LED elements



Maximum conductor cross section

1 or 2 2.5mm² or AWG14 cables. For 2.5mm² section, use rounded cable terminal with metal end at least 10mm

Certifications and compliance

Certifications obtained: UL Listed for USA and Canada, (cULus - File E93601), as Auxiliary Devices; EAC, CCC, RINA.

Compliant with standards: IEC/EN 60947-1, IEC/EN 60947-5-1, UL508, CSA C22.2 n° 14.

Contact elements, base mount on LPZ control stations

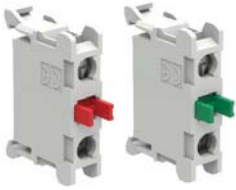

LPX CB...

Order code	Function	Qty per pkg	Wt
		n°	[kg]
Screw termination. Direct snap-on mounting on LPZ... control station base.			
LPX CB10	NO	10	0.012
LPX CB01	NC	10	0.012

- ❶ Not suitable for push-push actuators.
- ❷ Direct opening operation in accordance with IEC/EN 60947-5-1.

LED elements, steady light base mount on LPZ control stations

7



LPX LPB...

Order code	Rated supply voltage	LED color	Qty per pkg.	Wt
	[V]		n°	[kg]
Screw termination. Steady light. Direct snap-on mounting on LPZ... control station base.				
LPX LPB B3	12...30V AC/DC	Green	10	0.016
LPX LPB B4		Red	10	0.016
LPX LPB B5		Yellow	10	0.016
LPX LPB B6		Blue	10	0.016
LPX LPB B8		White	10	0.016
LPX LPB E3	85...140V AC	Green	10	0.016
LPX LPB E4		Red	10	0.016
LPX LPB E5		Yellow	10	0.016
LPX LPB E6		Blue	10	0.016
LPX LPB E8		White	10	0.016
LPX LPB M3	185...265V AC	Green	10	0.016
LPX LPB M4		Red	10	0.016
LPX LPB M5		Yellow	10	0.016
LPX LPB M6		Blue	10	0.016
LPX LPB M8		White	10	0.016

Total protection against overvoltages and stray currents in wiring, to reduce flickering phenomenon and withstand vibrations.

Operational characteristics

- Any mounting position allowed
- Snap-on mounting into fixing structures of LPZ control station base
- Maximum of 3 LPX CB... contact or 2 LPX CB... contact and 1 LPX LPB... LED elements (in middle pos. 3) for each actuator of LPZ control stations
- See the combinations given under "Contact elements" in the right-hand column for each type of pushbutton and selector switch
- For use with test elements, consult Customer Service; see contact details on inside front cover
- Maximum tightening torque for screw terminals: 1Nm
- Ambient conditions:
 - Operating temperature: -25...+70°C
 - Storage temperature: -40...+85°C
- Degree of protection: IP20.

General characteristics

CONTACT ELEMENTS
Wiping action and dual scraping-oscillating effect
IEC rated insulation voltage: 690V
IEC rated thermal current Ith: 10A
Conductivity: 5V 1mA
UL/CSA and IEC/EN 60947-5-1 designation: A600 Q600.
IEC/EN operational characteristics in AC15 category:
[V] 12 24 48 120 240 400 480 500 600
[A] 6 6 6 6 3 1.9 1.5 1.4 1.2
IEC/EN operational characteristics in DC13 category:
[V] 12 24 48 125 250 440 500 600
[A] 3 3 1.5 0.55 0.27 0.15 0.13 0.1

Short circuit protection fuse: max calibre: 10A gG/SC
Contact resistance: $\leq 20\text{m}\Omega$
Terminals: Clamp screw and washer.

Stroke of contact elements

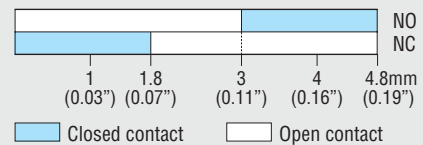

Mechanical and electrical endurance of contact elements

Opening force: $\leq 0.5\text{kg}/1.1\text{lb}$
Electrical life: 1,000,000 cycles for LPX CB10 and LPX CB01.

LED ELEMENTS

- Rated frequency: 50...60Hz
- Supply voltage:
 - 12...30VAC/DC; 85...140VAC; 185...265VAC
- Maximum consumption:
 - 17mA-0.50W (12...30VAC/DC); 20mA-0.40W (85...140VAC); 18mA-0.55W (185...265VAC)
- Total protection:
 - Against overvoltages
 - Against stray currents in wiring
 - To reduce flickering phenomenon
 - To withstand vibrations
- Minimum activation voltage:
 - steady light LPX LPB...: 4V-1mA (12...30VAC/DC); 30V-4mA (85...140VAC); 55V-4mA (185...265VAC)
- Electrical life: 100,000 hours.

Wiring diagram for LED elements



Maximum conductor cross section
1 or 2 2.5mm² or AWG14 cables.

Certifications and compliance

Certifications obtained: UL Listed for USA and Canada, (cULus - File E93601), as Auxiliary Devices; EAC, CCC, RINA.
Compliant with standards: IEC/EN 60947-1, IEC/EN 60947-5-1, UL508, CSA C22.2 n° 14.

Mounting position on the LPZ control station base

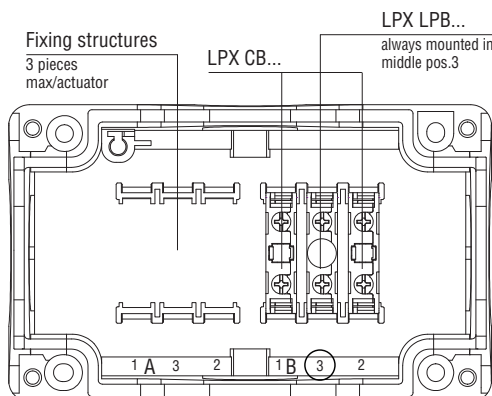

Without actuators



LPZ P1 A5



LPZ P2 A5



LPZ P3 A8

new

Order code	Description	Cover colour	Qty per pkg	Wt
			n°	[kg]
LPZ P1 A5	For 1 actuator	Yellow	1	0.107
LPZ P1 A8	For 1 actuator	Grey	1	0.107
LPZ P2 A5	For 2 actuators	Yellow	1	0.152
LPZ P2 A8	For 2 actuators	Grey	1	0.152
LPZ P3 A8	For 3 actuators	Grey	1	0.187
LPZ P4 A8	For 4 actuators	Grey	1	0.200
LPZ P5 A8	For 5 actuators	Grey	1	0.240
LPZ P6 A8	For 6 actuators	Grey	1	0.290

Control station base

Fixing structures for contact and/or LED elements
For each actuator: Maximum of 3 contacts or 2 contacts and 1 LED

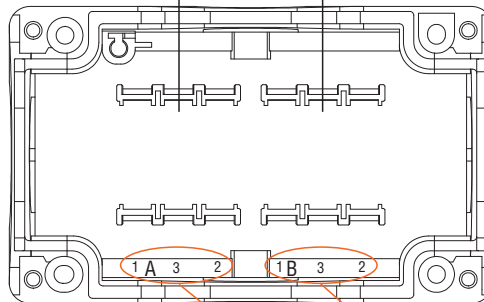

Control station cover (inside view)

Easy identification reference
For actuator and corresponding contact and/or LED elements

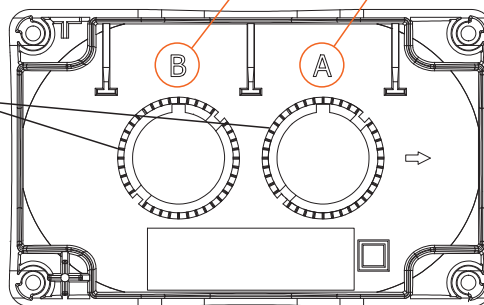

Anti-loosening action
Anti-rotation indents to extend fixing ring gripping over time

General characteristics

CONTROL STATIONS WITHOUT ACTUATOR

- 1 to 6 holes
- Compact dimensions
- Easy wiring for base-mount contact and LED elements; possible use of screw and spring-clamp terminal contact or LED elements on the inside surface of the cover using LPX AU120 mounting adapter
- Numerous cable entries.

CONTROL STATIONS WITH ACTUATOR

Standard supplied with actuator, label holder and STOP legend label excluding types with yellow cover, and one base-mount NC contact.

Operational characteristics

- Cable entry:
 - LPZ P1... knockouts:
 - M16/PG11 (1 at rear and 1 on left side)
 - M20/M25/PG13.5/PG16 (1 each on top and bottom)
 - LPZ P2... knockouts:
 - M16/PG11 (2 at rear)
 - M20/PG13.5 (1 on each side)
 - M20/M25/PG13.5/PG16 (1 each on top and bottom)
 - LPZ P3/P4/P5/P6 A8 knockouts:
 - M16/PG11 (2 at rear)
 - M20/PG13.5 (2 on each side)
 - M20/M25/PG13.5/PG16 (1 each on top and bottom)
- Any mounting position allowed
- Tightening torque of cover screws T_{max}: 1.8Nm/16lbin
- Ambient conditions:
 - Operating temperature: -25...+70°C
 - Storage temperature: -40...+85°C
- Degree of protection:
 - Per IEC/EN: IP66, IP67 and IP69K
 - Per UL: Type 1, 2, 3R, 4, 4X, 12K.

Materials

Polycarbonate.

Certifications and compliance

Certifications obtained: UL Listed for USA and Canada, (cULus - File E93601), as Auxiliary Devices; EAC, CCC, RINA.
Compliant with standards: IEC/EN 60947-1, IEC/EN 60947-5-1, UL508A for types without actuators / UL508 for types complete with actuator, CSA C22.2 n° 14.

With one actuator



LPZ P1 B8 02



LPZ P1 B5 03

Order code	Control station description	Actuator description	Qty per pkg	Wt
			n°	[kg]
LPZ P1 B8 01	Grey, 1 way LPZ P1 A8	Mushroom-head button LPC B6744 with STOP legend	1	0.150
LPZ P1 B8 02	Grey, 1 way LPZ P1 A8	Mushroom-head button LPC B6344 with STOP legend	1	0.135
LPZ P1 B5 02	Yellow, 1 way LPZ P1 A5	Mushroom-head button LPC B6344	1	0.135
LPZ P1 B5 03	Yellow, 1 way LPZ P1 A5	Mushroom-head button LPC B6644	1	0.150

① Version with red emergency stop, turn to release and yellow cover compliant with ISO 13850.

COMBINATIONS FOR PUSHBUTTONS AND SELECTOR SWITCHES

SPRING-RETURN BUTTONS

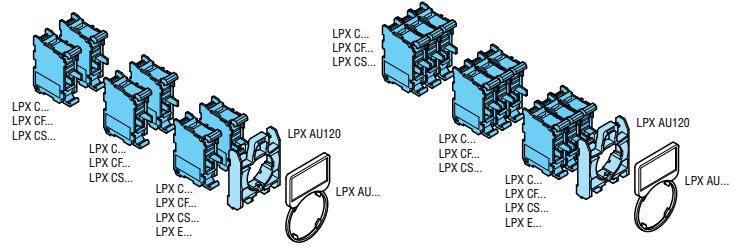

PUSH-PUSH BUTTONS

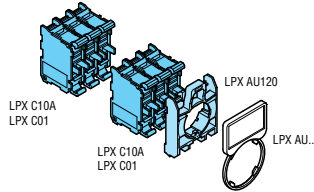
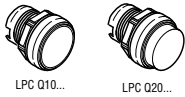

MUSHROOM-HEAD SPRING-RETURN BUTTONS

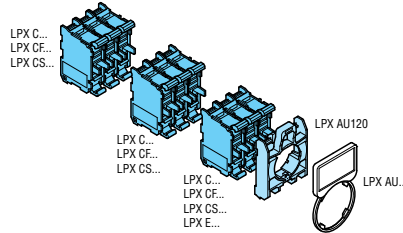
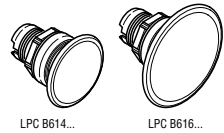

MUSHROOM-HEAD LATCH BUTTONS

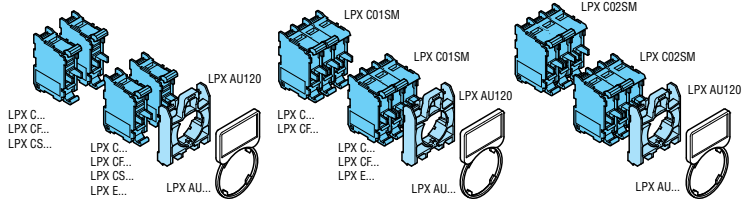
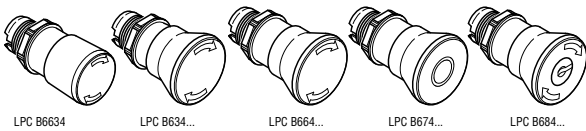

DOUBLE-TOUCH BUTTONS

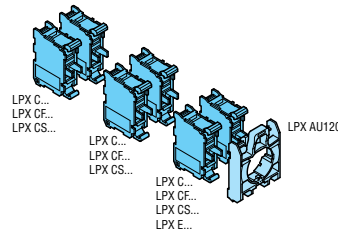
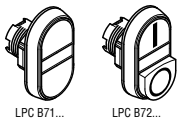

TRIPLE-TOUCH BUTTONS

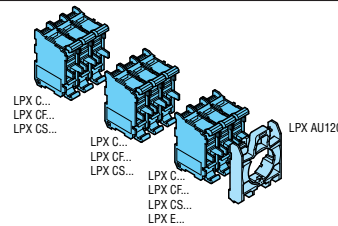

SELECTOR SWITCHES

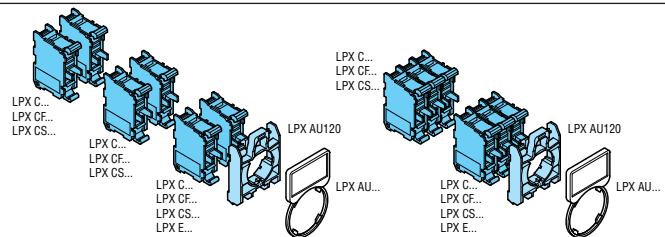
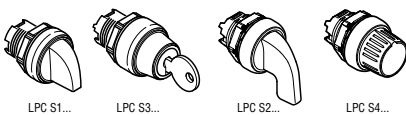

MECHANICAL SPRING-RETURN RESET BUTTONS

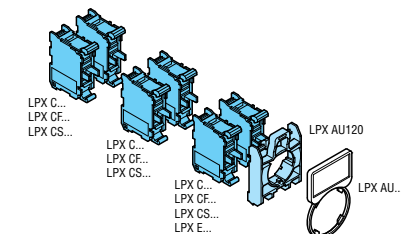
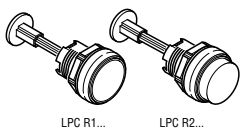

COMBINATIONS FOR ILLUMINATED PUSHBUTTONS AND SELECTOR SWITCHES

SPRING-RETURN BUTTONS

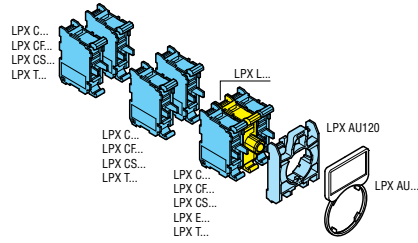
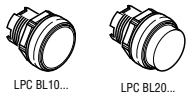

PUSH-PUSH BUTTONS

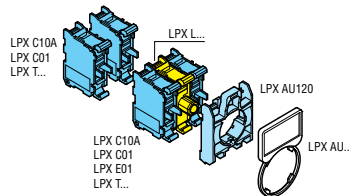
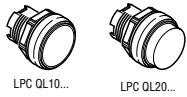

MUSHROOM-HEAD SPRING-RETURN BUTTON

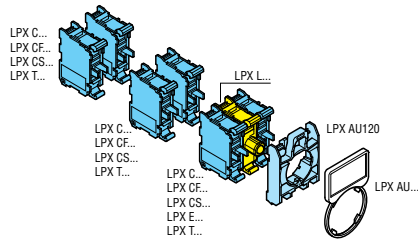

MUSHROOM-HEAD LATCH BUTTON

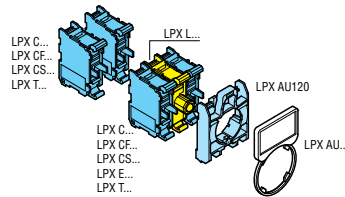
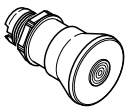

DOUBLE-TOUCH BUTTONS

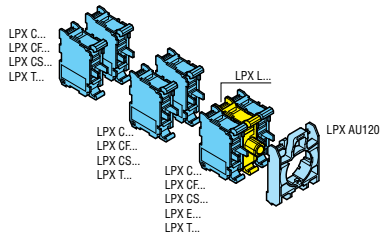
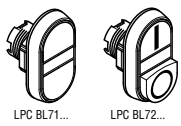

2 AND 3 POSITION SELECTOR SWITCHES

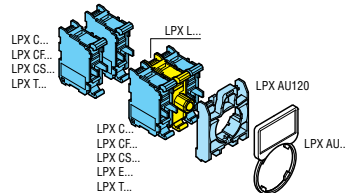
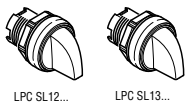

CONTROL STATIONS

Example of 2 way control station equipped with selector switch, label holder and label along with pilot light

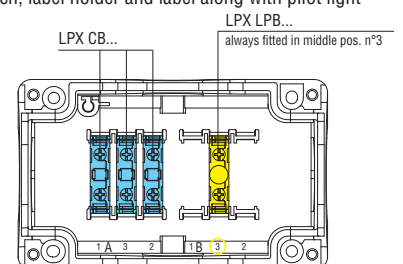
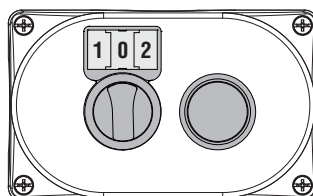

Pushbutton actuators, spring return



8 LM2T B10...



8 LM2T B20...



8 LM2T B30...

Order code	Colour	Qty per pkg	Wt
		n°	[kg]

Flush (without mounting adapter). Spring return.

8 LM2T B102	Black	10	0.033
8 LM2T B103	Green	10	0.033
8 LM2T B104	Red	10	0.033
8 LM2T B105	Yellow	10	0.033
8 LM2T B106	Blue	10	0.033
8 LM2T B108	White	10	0.033

Extended (without mounting adapter). Spring return.

8 LM2T B202	Black	10	0.035
8 LM2T B203	Green	10	0.035
8 LM2T B204	Red	10	0.035
8 LM2T B205	Yellow	10	0.035
8 LM2T B206	Blue	10	0.035
8 LM2T B208	White	10	0.035

Shrouded (without mounting adapter). Spring return.

8 LM2T B302	Black	10	0.035
8 LM2T B303	Green	10	0.035
8 LM2T B304	Red	10	0.035
8 LM2T B305	Yellow	10	0.035
8 LM2T B306	Blue	10	0.035
8 LM2T B308	White	10	0.035

Push-push button actuators



8 LM2T Q10...



8 LM2T Q20...

Order code	Colour	Qty per pkg	Wt
		n°	[kg]

Flush (without mounting adapter). Push on-push off.

8 LM2T Q102Ⓢ	Black	10	0.033
8 LM2T Q103Ⓢ	Green	10	0.033
8 LM2T Q104Ⓢ	Red	10	0.033
8 LM2T Q105Ⓢ	Yellow	10	0.033
8 LM2T Q106Ⓢ	Blue	10	0.033
8 LM2T Q108Ⓢ	White	10	0.033

Extended (without mounting adapter). Push on-push off.

8 LM2T Q202Ⓢ	Black	10	0.035
8 LM2T Q203Ⓢ	Green	10	0.035
8 LM2T Q204Ⓢ	Red	10	0.035
8 LM2T Q205Ⓢ	Yellow	10	0.035
8 LM2T Q206Ⓢ	Blue	10	0.035
8 LM2T Q208Ⓢ	White	10	0.035

Ⓢ Use contact elements EM (8 LM2T C10A) and NC (8LM2T C01) only. Contact elements NO (8LM2T C10) and LB (8LM2T C01D) cannot be fitted on these actuators. For the number of contact elements, refer to indications in the right-hand column.

Operational characteristics

- Any mounting position allowed
- Ambient conditions:
 - Operating temperature: -25...+60°C
 - Storage temperature: -40...+70°C
- Degree of protection:
 - Per IEC/EN: IP65
 - Per UL/CSA: Type 1, 2, 3R, 4, 4X, 12, 12K.

Materials

An aluminium and zinc alloy (zama) is used for the metal part whereas plastic parts are made of polyamide and polycarbonate.

Mechanical endurance

Operating force: 0.8kg/1.7lb (actuator).

Mechanical life:

- Spring-return actuators: 1,000,000 cycles
- Push-push actuators: 500,000 cycles.

Mounting adapter

See page 7-41.

Type: LM2T AU120.

The adapter is fixed to the mounting surface by means of incorporated screws (Tmax = 0.8Nm/0.59lbf).

Actuators latch onto the mounting adapter by simple rotation through a Ø22mm/Ø0.87" drilling also on the cover of LPZ control stations.

Contact elements for spring-return actuators

See page 7-41.

Type: LM2T C10 (1NO)
 LM2T CF10 (1NO Faston)
 LM2T C10A (1EM)
 LM2T C01 (1NC)
 LM2T CF01 (1NC Faston)
 LM2T C01D (1LB)

Contact elements snap onto the mounting adapter.

Up to 6 contacts can be fitted: 2 each on the left, middle and right, one behind the other.

Up to 3 contacts per actuator can be internally fitted on the cover surface of LPZ control stations.

To use contact elements in the middle position, install the action plug LM2T A140 on the actuator; see page 7-38.

Contact elements for push-push button actuators

See page 7-41.

Type: LM2T C10A (1EM)
 LM2T C01 (1NC)

Contact elements snap onto the mounting adapter.

Up to 2 contacts can be fitted: 1 each on the right and left.

Up to 2 contacts per actuator can be internally fitted on the cover surface of LPZ control stations (only one on the right and/or on the left).

Certifications and compliance

Certifications obtained: UL Listed for USA and Canada, (cULus - File E93601), as Auxiliary Devices; EAC, RINA, LROS, CCC.

Compliant with standards: IEC/EN 60947-1, IEC/EN 60947-5-1, UL508, CSA C22.2 n° 14

Mechanical reset button, complete unit, spring return



8 LM2T R1196

Order code	Colour	Qty per pkg. n°	Wt [kg]
------------	--------	--------------------	------------

Flush (5.2mm/0.2" stroke). Adjustable length 0-140mm/5.5".
Spring return (complete with shaft and mounting adapter)Ⓜ

8 LM2T R1002	Black	10	0.065
8 LM2T R1003	Green	10	0.065
8 LM2T R1004	Red	10	0.065
8 LM2T R1006	Blue	10	0.065
8 LM2T R1196Ⓜ	Blue (RESET)	10	0.065

Extended (5.2mm/0.2" stroke). Adjustable length 0-140mm/5.5".

Spring return (complete with shaft and mounting adapter)Ⓜ

8 LM2T R2004	Red	10	0.067
--------------	-----	----	-------

- Ⓜ With "RESET" caption on actuator.
- Ⓜ No contact elements can be fitted.

Pushbutton actuators, spring return, with symbol



8 LM2T B11...



8 LM2T B21...

Order code	Symbol	Colour	Qty per pkg. n°	Wt [kg]
------------	--------	--------	--------------------	------------

Flush (without mounting adapter). Spring return.

8 LM2T B1102	0	Black	10	0.033
8 LM2T B1104		Red	10	0.033
8 LM2T B1113	I	Green	10	0.033
8 LM2T B1118		White	10	0.033
8 LM2T B1123	II	Green	10	0.033
8 LM2T B1128		White	10	0.033
8 LM2T B1132	STOP	Black	10	0.033
8 LM2T B1134		Red	10	0.033
8 LM2T B1142	← Ⓜ	Black	10	0.033
8 LM2T B1148		White	10	0.033
8 LM2T B1152	↑ Ⓜ	Black	10	0.033
8 LM2T B1158		White	10	0.033
8 LM2T B1163	START	Green	10	0.033
8 LM2T B1168		White	10	0.033
8 LM2T B1176	R	Blue	10	0.033
8 LM2T B1178		White	10	0.033
8 LM2T B1196	RESET	Blue	10	0.033
8 LM2T B1502	↔	Black	10	0.033
8 LM2T B1512	↔	Black	10	0.033

Extended (without mounting adapter). Spring return.

8 LM2T B2102	0	Black	10	0.035
8 LM2T B2104		Red	10	0.035
8 LM2T B2132	STOP	Black	10	0.035
8 LM2T B2134		Red	10	0.035

- Ⓜ Arrow symbol can be used to indicate right or left.
- Ⓜ Arrow symbol can be used to indicate up or down.

Operational characteristics

- Any mounting position allowed
- Ambient conditions:
 - Operating temperature: -25...+60°C
 - Storage temperature: -40...+70°C
- Degree of protection:
 - Per IEC/EN: IP65
 - Per UL/CSA: Type 1, 2, 3R, 4, 4X, 12, 12K.

Materials

An aluminium and zinc alloy (zama) is used for the metal part whereas plastic parts are made of polyamide and polycarbonate.

Mechanical endurance

Operating force: 0.8kg/1.7lb (actuator)
Mechanical life: 1,000,000 cycles.

Mounting adapter

See page 7-41.

Type: LM2T AU120.

The adapter is fixed to the mounting surface by means of incorporated screws (Tmax = 0.8Nm/0.59lbft).

Actuators latch onto the mounting adapter by simple rotation through a Ø22mm/Ø0.87" drilling also on the cover of LPZ control stations.

Contact elements for spring-return actuators with symbols

See page 7-41.

Type: LM2T C10 (1NO)
LM2T CF10 (1NO Faston)
LM2T C10A (1EM)
LM2T C01 (1NC)
LM2T CF01 (1NC Faston)
LM2T C01D (1LB)

Contact elements snap onto the mounting adapter.

Up to 6 contacts can be fitted: 2 each on the left, middle and right, one behind the other.

Up to 3 contacts per actuator can be internally fitted on the cover surface of LPZ control stations.

To use contact elements in the middle position, install the action plug LM2T A140 on the actuator; see page 7-38.

Certifications and compliance

Certifications obtained: UL Listed for USA and Canada, (cULus - File E93601), as Auxiliary Devices; EAC, RINA, LROS, CCC.

Compliant with standards: IIEC/EN 60947-1, IEC/EN 60947-5-1, UL508, CSA C22.2 n° 14.

Mushroom head pushbutton actuators



8 LM2T B614...



8 LM2T B616...



8 LM2T B624...



8 LM2T B634...



8 LM2T B664...



8 LM2T B654...

Order code	Colour	Qty per pkg	Wt
		n°	[kg]

SPRING RETURN.
Ø40mm/1.6" (without mounting adapter).

8 LM2T B6142	Black	10	0.037
8 LM2T B6143	Green	10	0.037
8 LM2T B6144	Red	10	0.037
8 LM2T B6145	Yellow	10	0.037
8 LM2T B6146	Blue	10	0.037

Ø60mm/2.4" (without mounting adapter).

8 LM2T B6162	Black	10	0.043
8 LM2T B6163	Green	10	0.043
8 LM2T B6164	Red	10	0.043
8 LM2T B6165	Yellow	10	0.043
8 LM2T B6166	Blue	10	0.043

LATCH, PULL TO RELEASE.
Ø40mm/1.6" (without mounting adapter).
For normal stopping.

8 LM2T B6242	Black	10	0.105
8 LM2T B6244	Red	10	0.105

LATCH, TURN TO RELEASE.
Ø40mm/1.6" (without mounting adapter).
For normal stopping.

8 LM2T B6342	Black	10	0.054
8 LM2T B6344	Red	10	0.054

Ø40mm/1.6" (without mounting adapter).
For emergency stopping, ISO 13850 compliant.

8 LM2T B6644	Red	10	0.087
--------------	-----	----	-------

LATCH, TURN KEY TO RELEASE.
Ø40mm/1.6" (without mounting adapter).
For normal stopping.

8 LM2T B6542	Black	10	0.091
8 LM2T B6542G①		1	0.091
8 LM2T B6544	Red	10	0.091
8 LM2T B6544G①		1	0.091

① Versions with different key codes.
Complete with the numeric code of the key. The following versions are available: 501, 502, 503, 504, 505, 506, 507, 508, 509, 510.
Example of complete code: 8 LM2T B6542G505.

Operational characteristics

- Any mounting position allowed
- Ambient conditions:
 - Operating temperature: -25...+60°C
 - Storage temperature: -40...+70°C
- Degree of protection:
 - Per IEC/EN: IP66 for mushroom buttons (IP65 for LM2T B654...)
 - Per UL: Type 1, 2, 3R, 4, 4X, 12, 12K except for 8 LM2T B616 which is Type 1, 2, 3R, 12, 12K.

Materials

An aluminium and zinc alloy (zama) is used for the metal part whereas plastic parts are made of polyamide and polycarbonate.

Mechanical endurance

Operating force: 0.8kg/1.7lb (actuator).

Mechanical life:

- Mushroom head spring return buttons: 1,000,000 cycles
- Mushroom head latch buttons: 300,000 cycles.

Mounting adapter

See page 7-41.

Type: LM2T AU120.

The adapter is fixed to the mounting surface by means of incorporated screws (Tmax = 0.8Nm).

Actuators latch onto the mounting adapter by simple rotation through a Ø22mm/Ø0.87" drilling also on the cover of LPZ control stations.

Contact elements

SPRING RETURN MUSHROOM - HEAD BUTTONS

See page 7-41.

- Type:
- LM2T C10 (1NO)
 - LM2T CF10 (1NO Faston)
 - LM2T C10A (1EM)
 - LM2T C01 (1NC)
 - LM2T CF01 (1NC Faston)
 - LM2T C01D (1LB)

Contact elements snap onto the mounting adapter.

Up to 6 contacts can be fitted: 2 each on the left, middle and right, one behind the other.

Up to 3 contacts per actuator can be internally fitted the cover surface of LPZ control stations.

To use contact elements in the middle position, install on the action plug LM2T A140 on the actuator; see page 7-38.

LATCH MUSHROOM - HEAD BUTTONS

Up to 6 contacts can be fitted: 2 each on the left, middle and right, one behind the other. (for LM2T B624... and LM2T B6644 max 4 contacts).

Up to 3 contacts per actuator can be internally fitted the cover surface of LPZ control stations.

Certifications and compliance

Certifications obtained: UL Listed for USA and Canada, (cULus - File E93601), as Auxiliary Devices; EAC, RINA, LROS, CCC.

Compliant with standards: IEC/EN 60947-1, IEC/EN 60947-5-1, UL508, CSA C22.2 n° 14.

Double-touch actuators, spring return



8 LM2T B71...



8 LM2T B72...

Order code	Colour	Symbols	Qty per pkg. n°	Wt [kg]
------------	--------	---------	--------------------	------------

Two flush push-buttons (without mounting adapter).
Both spring return.

8 LM2T B7112	Black/Red	none	5	0.044
8 LM2T B7113	Green/Red	none	5	0.044
8 LM2T B7114	White/Black	none	5	0.044
8 LM2T B7122	Black/Red	I-O	5	0.044
8 LM2T B7123	Green/Red	I-O	5	0.044
8 LM2T B7124	White/Black	I-O	5	0.044
8 LM2T B7133	Green/Red	Start/Stop	5	0.044

One extended and one flush push-button (without mounting adapter). Both spring return.

8 LM2T B7212	Black/Red	none	5	0.044
8 LM2T B7213	Green/Red	none	5	0.044
8 LM2T B7214	White/Black	none	5	0.044
8 LM2T B7222	Black/Red	I-O	5	0.044
8 LM2T B7223	Green/Red	I-O	5	0.044
8 LM2T B7224	White/Black	I-O	5	0.044
8 LM2T B7233	Green/Red	Start/Stop	5	0.044

Triple-touch actuators, spring return



8 LM2T B73...

Order code	Symbols	Qty per pkg. n°	Wt [kg]
------------	---------	--------------------	------------

Triple-touch actuator (without mounting adapter).
Spring return.

8 LM2T B7345	 STOP 	5	0.044
8 LM2T B7355	↑ STOP ↓	5	0.044
8 LM2T B7365	→ STOP ←	5	0.044
8 LM2T B7375	↗ STOP ↙	5	0.044

Operational characteristics

- Any mounting position allowed
- Ambient conditions:
 - Operating temperature: -25...+60°C
 - Storage temperature: -40...+70°C
- Degree of protection:
 - Per IEC/EN: IP40.
 - Per UL/CSA: Type 1.

Materials

An aluminium and zinc alloy (zama) is used for the metal part whereas plastic parts are made of polyamide and polycarbonate.

Mechanical endurance

Operating force: 0.8kg/1.7lb (actuator)
Mechanical life: 1,000,000 cycles.

Mounting adapter

See page 7-41.

Type: LM2T AU120.

The adapter is fixed to the mounting surface by means of incorporated screws (T_{max} = 0.8Nm/0.59lbf). Actuators latch onto the mounting adapter by simple rotation through a Ø22mm/Ø0.87" drilling also on the cover of LPZ control stations.

Contact elements

See page 7-41.

Type:

LM2T C10 (1NO)
LM2T CF10 (1NO Faston)
LM2T C10A (EM)
LM2T C01 (1NC)
LM2T CF01 (1NC Faston)
LM2T C01D (LB)

Contact elements snap onto the mounting adapter.

FOR DOUBLE-TOUCH BUTTONS

Up to 4 contacts can be fitted: 2 each on the left and right, one behind the other.

Up to 2 contacts per actuator can be internally fitted on the cover surface of LPZ control stations, 1 on the left and right.

FOR TRIPLE-TOUCH BUTTONS

Up to 6 contacts can be fitted: 2 each on the left, middle and right, one behind the other.

Up to 3 contacts per actuator can be internally fitted on the cover surface of LPZ control stations.

Certifications and compliance

Certifications obtained: UL Listed for USA and Canada, (cULus - File E93601), as Auxiliary Devices; EAC, RINA, LROS, CCC.

Compliant with standards: IEC/EN 60947-1, IEC/EN 60947-5-1, UL508, CSA C22.2 n° 14.

Selector switch actuators short lever



8 LM2T S1...

Order code	Type of position	Qty per pkg	Wt
		n°	[kg]
2 position (without mounting adapter).			
8 LM2T S120		10	0.049
8 LM2T S121		10	0.049
3 position (without mounting adapter).			
8 LM2T S130		10	0.049
8 LM2T S131		10	0.049
8 LM2T S132		10	0.049
8 LM2T S133		10	0.049

Selector switch actuators long lever

7



8 LM2T S2...

Order code	Type of position	Qty per pkg	Wt
		n°	[kg]
2 position (without mounting adapter).			
8 LM2T S220		10	0.050
8 LM2T S221		10	0.050
3 position (without mounting adapter).			
8 LM2T S230		10	0.050
8 LM2T S231		10	0.050
8 LM2T S232		10	0.050
8 LM2T S233		10	0.050

Selector switch actuators key



8 LM2T S3...

Order code	Type of position	Qty per pkg	Wt
		n°	[kg]
2 position (without mounting adapter).			
8 LM2T S320		10	0.079
8 LM2T S320GⓂ		1	0.079
8 LM2T S321		10	0.079
8 LM2T S321GⓂ		1	0.079
8 LM2T S340		10	0.079
8 LM2T S340GⓂ		1	0.079
3 position (without mounting adapter).			
8 LM2T S330		10	0.080
8 LM2T S330GⓂ		1	0.080
8 LM2T S331		10	0.080
8 LM2T S331GⓂ		1	0.080
8 LM2T S332Ⓜ		10	0.080
8 LM2T S332GⓂⓂ		1	0.080
8 LM2T S333Ⓜ		10	0.080
8 LM2T S333GⓂⓂ		1	0.080
8 LM2T S350		10	0.080
8 LM2T S350GⓂ		1	0.080
8 LM2T S360		10	0.080
8 LM2T S360GⓂ		1	0.080
8 LM2T S370Ⓜ		10	0.080
8 LM2T S370GⓂⓂ		1	0.080
8 LM2T S380Ⓜ		10	0.080
8 LM2T S380GⓂⓂ		1	0.080
8 LM2T S390Ⓜ		10	0.080
8 LM2T S390GⓂⓂ		1	0.080

Operational characteristics

- Any mounting position allowed
- Ambient conditions:
 - Operating temperature: -25...+60°C
 - Storage temperature: -40...+70°C
- Degree of protection:
 - Per IEC/EN: IP65
 - Per UL/CSA: Type 1, 2, 3R, 4, 4X, 12, 12K.

Materials

An aluminium and zinc alloy (zama) is used for the metal part whereas plastic parts are made of polyamide and polycarbonate.

Mechanical endurance

Mechanical life: 300,000 cycles.

Mounting adapter

See page 7-41.

Type: LM2T AU120.

The adapter is fixed to the mounting surface by means of incorporated screws (Tmax = 0.8Nm/0.59").

Actuators latch onto the mounting adapter by simple rotation through a Ø22mm/Ø0.87" drilling also on the cover of LPZ control stations.

Contact elements

See page 7-41.

- Type:
- LM2T C10 (1NO)
 - LM2T CF10 (1NO Faston)
 - LM2T C10A (1EM)
 - LM2T C01 (1NC)
 - LM2T CF01 (1NC Faston)
 - LM2T C01D (1LB)

Contact elements snap onto the mounting adapter.

Up to 4 contacts can be fitted: 2 each on the left and right, one behind the other.

Up to 2 contacts per actuator can be internally fitted on the cover surface of LPZ control stations, 1 on the left and right.

For combination with more than 4 contacts, consult Customer Service for advice; see contact details on inside front cover.

Type of positions

- Maintained position.
- Spring return position.
- Key extraction position.

Rotation angles

2 position



3 position



Special versions

Versions with coloured keys are available upon request.

Consult our Customer Service; see contact details on inside front cover.

Certifications and compliance

Certifications obtained: UL Listed for USA and Canada, (cULus - File E93601), as Auxiliary Devices; EAC, RINA, LROS, CCC.

Compliant with standards: IEC/EN 60947-1, IEC/EN 60947-5-1, UL508, CSA C22.2 n° 14.

① Versions with different key codes.

Complete with the numeric code of the key. The following versions are available: 501; 502; 503; 504; 505; 506; 507; 508; 509; 510. Example of complete code: 8 LM2T S320G505.

② Available only on specific request.

Contact activation for 2-position selector switch

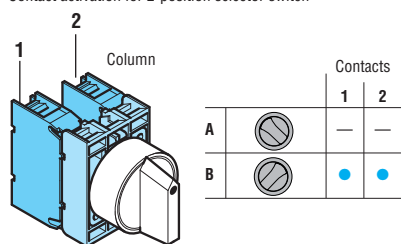

Contact activation of 3-position selector switch

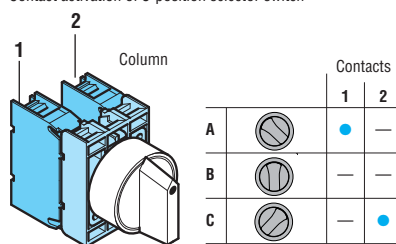

Illuminated button actuators, spring return



8 LM2T BL10...



8 LM2T BL20...

Order code	Colour	Qty per pkg n°	Wt [kg]
------------	--------	-------------------	------------

Flush with side visibility (without mounting adapter).
Spring return.

8 LM2T BL103	Green	10	0.033
8 LM2T BL104	Red	10	0.033
8 LM2T BL105	Yellow	10	0.033
8 LM2T BL106	Blue	10	0.033
8 LM2T BL107	Transparent	10	0.033

Extended (without mounting adapter). Spring return.

8 LM2T BL203	Green	10	0.035
8 LM2T BL204	Red	10	0.035
8 LM2T BL205	Yellow	10	0.035
8 LM2T BL206	Blue	10	0.035
8 LM2T BL207	Transparent	10	0.035

Illuminated button actuators push-push



8 LM2T QL10...



8 LM2T QL20...

Order code	Colour	Qty per pkg n°	Wt [kg]
------------	--------	-------------------	------------

Flush with side visibility (without mounting adapter).
Push on-push off.

8 LM2T QL103	Green	10	0.033
8 LM2T QL104	Red	10	0.033
8 LM2T QL105	Yellow	10	0.033
8 LM2T QL106	Blue	10	0.033
8 LM2T QL107	Transparent	10	0.033

Extended (without mounting adapter).
Push on-push off.

8 LM2T QL203	Green	10	0.035
8 LM2T QL204	Red	10	0.035
8 LM2T QL205	Yellow	10	0.035
8 LM2T QL206	Blue	10	0.035
8 LM2T QL207	Transparent	10	0.035

⚠ Use contact elements EM (8LM2T C10A early make) and NC (8LM2T C01) only.
Contact elements NO (8LM2T C10) and LB (8LM2T C01D late break) cannot be used with these actuators. For the number of contact elements, refer to the right-hand column.

Operational characteristics

- Any mounting position allowed
- Ambient conditions:
 - Operating temperature: -25...+60°C
 - Storage temperature: -40...+70°C
- Degree of protection:
 - Per IEC/EN: IP65
 - Per UL: Type 1, 2, 3R, 4, 4X, 12, 12K.

Materials

An aluminium and zinc alloy (zama) is used for the metal part whereas plastic parts are made of polyamide and polycarbonate.

Mechanical endurance

- Operating force: 0.8kg/1.7lb (actuator).
Mechanical life:
- Spring return buttons: 1,000,000 cycles
 - Push-push buttons: 500,000 cycles.

Mounting adapter

See page 7-41.
Type: LM2T AU120.
The adapter is fixed to the mounting surface by means of incorporated screws (Tmax = 0.8Nm/0.59lbf).
Actuators latch onto the mounting adapter by simple rotation through a Ø22mm/Ø0.87" drilling also on the cover of LPZ control stations.

Contact elements for illuminated spring-return buttons

See page 7-41.
Type: LM2T C10 (1NO)
LM2T CF10 (1NO Faston)
LM2T C10A (EM)
LM2T C01 (1NC)
LM2T CF01 (1NC Faston)
LM2T C01D (LB)

Contact elements snap onto the mounting adapter. Up to 4 contacts can be fitted, 2 each on the left and right one behind the other, when one of the lamp-holders type LM2T DL400, LM2T EL400, LM2T ZL230, LM2T L... or LM2T M... is used (see page 7-42 or 43).
On the cover of LPZ control stations, up to 2 contacts per actuator can be internally fitted, 1 each on the right and/or left, when one of the lamp-holders type LM2T DL400, LM2T EL400, LM2T ZL230, LM2T L... or LM2T M... is used in the middle position.
Instead when using lamp-holder LM2T YL... or LM2T GL..., up to 2 contacts only can be fitted one behind the other (see page 7-42).

Contact elements for illuminated push-push buttons

See page 7-41.
Type: LM2T C10A (EM)
LM2T C01 (1NC)

Contact elements snap onto the mounting adapter. Up to 2 contact elements can be fitted with one of the lamp-holders type LM2T DL400, LM2T EL400, LM2T ZL230, LM2T L... or LM2T M... (see page 7-40 or 41).
On the cover of LPZ control stations, up to 2 contacts per actuator can be internally fitted, 1 each on the right and/or left, when one of the lamp-holders type LM2T DL400, LM2T EL400, LM2T ZL230, LM2T L... or LM2T M... is used in the middle position.
Only 1 contact can be fitted with lamp-holders LM2T YL..., LM2T GL... (see page 7-42).

Lamp-holder elements

See page 7-42 and 43.

Lamps

Maximum recommended power: 1.2W.
See page 7-38.

Certifications and compliance

Certifications obtained: UL Listed for USA and Canada, (cULus - File E93601), as Auxiliary Devices; EAC, RINA, LROS, CCC.
Compliant with standards: IEC/EN 60947-1, IEC/EN 60947-5-1, UL508, CSA C22.2 n° 14.

Illuminated mushroom head button actuators



8 LM2T BL614...



8 LM2T BL624...

Order code	Colour	Quantity per pkg.	Wt
		n°	[kg]

SPRING RETURN.
Ø40mm/1.6" (without mounting adapter)..

8 LM2T BL6143	Green	10	0.043
8 LM2T BL6144	Red	10	0.043
8 LM2T BL6145	Yellow	10	0.043
8 LM2T BL6146	Blue	10	0.043
8 LM2T BL6148	White	10	0.043

LATCH, PULL TO RELEASE.
Ø40mm/1.6" (without mounting adapter).

8 LM2T BL6243	Green	10	0.105
8 LM2T BL6244	Red	10	0.105
8 LM2T BL6245	Yellow	10	0.105
8 LM2T BL6246	Blue	10	0.105
8 LM2T BL6248	White	10	0.105

Double touch actuators, spring return, white indicator



8 LM2T BL71...



8 LM2T BL72...

Order code	Colour	Symbol	Quantity per pkg.	Wt
			n°	[kg]

Two flush pushbuttons (without mounting adapter).
Both spring return.

8 LM2T BL7112	Black/Red	none	5	0.044
8 LM2T BL7113	Green/Red	none	5	0.044
8 LM2T BL7114	White/Black	none	5	0.044
8 LM2T BL7122	Black/Red	I-O	5	0.044
8 LM2T BL7123	Green/Red	I-O	5	0.044
8 LM2T BL7124	White/Black	I-O	5	0.044
8 LM2T BL7133	Green/Red	Start/Stop	5	0.044

One extended and one flush pushbuttons (without mounting adapter). Both spring return.

8 LM2T BL7212	Black/Red	—	5	0.044
8 LM2T BL7213	Green/Red	—	5	0.044
8 LM2T BL7214	White/Black	—	5	0.044
8 LM2T BL7222	Black/Red	I-O	5	0.044
8 LM2T BL7223	Green/Red	I-O	5	0.044
8 LM2T BL7224	White/Black	I-O	5	0.044
8 LM2T BL7233	Green/Red	Start/Stop	5	0.044

Operational characteristics

- Any mounting position allowed
- Ambient conditions:
 - Operating temperature: -25...+60°C
 - Storage temperature: -40...+70°C
- Degree of protection:
 - Per IEC/EN: IP65 for mushroom-head actuators; IP40 for double-touch actuators.
 - Per UL: Type 1, 2, 3R, 4, 4X, 12, 12K except for 8 LM2T BL71... and 8 LM2T BL72... which are Type 1.

Materials

An aluminium and zinc alloy (zama) is used for the metal part whereas plastic parts are made of polyamide and polycarbonate.

Mechanical endurance

Operating force: 0.8kg/1.7lb (actuator).
Mechanical life: 1,000,000 cycles.

Mounting adapter

See page 7-41.

Type: LM2T AU120.

The adapter is fixed to the mounting surface by means of incorporated screws (T_{max} = 0.8Nm/0.59lbf).

Actuators latch onto the mounting adapter by simple rotation through a Ø22mm/Ø0.87" drilling also on the cover of LPZ control stations.

Contact elements

See page 7-41.

Type: LM2T C10 (1NO)
LM2T CF10 (1NO Faston)
LM2T C10A (1EM)
LM2T C01 (1NC)
LM2T CF01 (1NC Faston)
LM2T C01D (1LB)

Contact elements snap onto the mounting adapter.

MUSHROOM-HEAD BUTTONS

Can be mounted on the mounting adapter:

- Up to 4 contacts, 2 each on the left and right, one behind the other, when one of the lamp-holders: LM2T DL400, LM2T EL400, LM2T ZL230, LM2T L... is used or 2 contacts LM2T M... (see page 7-40 or 41).
- On the cover of LPZ control station, up to 2 contacts per actuator can be internally fitted, 1 each on the right and/or left, when one of the lamp-holders type LM2T DL400, LM2T EL400, LM2T ZL230, LM2T L... or LM2T M... is used in the middle position.
- Up to 2 contacts, one over the other, when one of the lamp-holders type: LM2T YL... or LM2T GL... is used (see page 7-40).

DOUBLE-TOUCH BUTTONS

Up to 4 contacts can be fitted: 2 each on the left and right.
Up to 2 contacts per actuator can be internally fitted on the cover of LPZ control stations, 1 each on the right and/or left when one of the lamp-holders type LM2T DL400, LM2T EL400, LM2T ZL230, LM2T L... or LM2T M... is used in the middle position.

Lamp-holder elements

See page 7-42 and 43.

Lamps

Maximum recommended power: 1.2W.
See page 7-38.

Certifications and compliance

Certifications obtained: UL Listed for USA and Canada, (cULus - File E93601), as Auxiliary Devices; EAC, RINA, LROS, CCC.

Compliant with standards: IEC/EN 60947-1, IEC/EN 60947-5-1, UL508, CSA C22.2 n° 14.

Illuminated selector switch actuators



8 LM2T SL1...

Order code	Colour	Type of positions	Qty per pkg n°	Wt [kg]
2 position (without mounting adapter).				
8 LM2T SL1203	Green	↙	10	0.025
8 LM2T SL1204	Red		10	0.025
8 LM2T SL1205	Yellow		10	0.025
8 LM2T SL1206	Blue		10	0.025
8 LM2T SL1208	White		10	0.025
8 LM2T SL1213	Green	↘	10	0.025
8 LM2T SL1214	Red		10	0.025
8 LM2T SL1215	Yellow		10	0.025
8 LM2T SL1216	Blue		10	0.025
8 LM2T SL1218	White		10	0.025
3 position (without mounting adapter).				
8 LM2T SL1303	Green	↙	10	0.025
8 LM2T SL1304	Red		10	0.025
8 LM2T SL1305	Yellow		10	0.025
8 LM2T SL1306	Blue		10	0.025
8 LM2T SL1308	White	↘	10	0.025
8 LM2T SL1313	Green		10	0.025
8 LM2T SL1314	Red		10	0.025
8 LM2T SL1315	Yellow		10	0.025
8 LM2T SL1316	Blue	↘	10	0.025
8 LM2T SL1318	White		10	0.025
8 LM2T SL1323	Green		10	0.025
8 LM2T SL1324	Red		10	0.025
8 LM2T SL1325	Yellow	↙	10	0.025
8 LM2T SL1326	Blue		10	0.025
8 LM2T SL1328	White		10	0.025
8 LM2T SL1333	Green		10	0.025
8 LM2T SL1334	Red	↘	10	0.025
8 LM2T SL1335	Yellow		10	0.025
8 LM2T SL1336	Blue		10	0.025
8 LM2T SL1338	White		10	0.025

Contact activation of 2-position selector switch

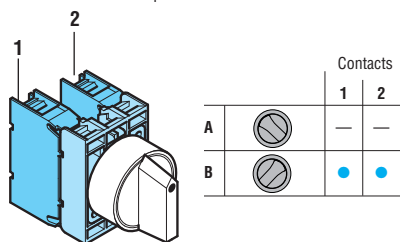

Contact activation of 3-position selector switch

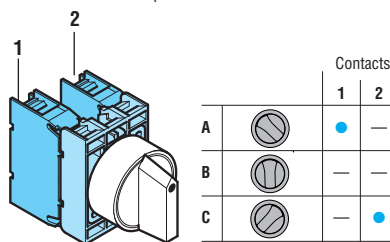

Operational characteristics

- Any mounting position allowed
- Ambient conditions:
 - Operating temperature: -25...+60°C
 - Storage temperature: -40...+70°C
- Degree of protection:
 - Per IEC/EN: IP65
 - IP40 for actuators.
 - Per UL: Type 1, 2, 3R, 4, 4X, 12, 12K.

Materials

An aluminium and zinc alloy (zama) is used for the metal part whereas plastic parts are made of polyamide and polycarbonate.

Mechanical endurance

Operating force: 0.8kg/1.7lb (actuator).
Mechanical life: 300,000 cycles.

Mounting adapter

See page 7-41.
Type: LM2T AU120.

The adapter is fixed to the mounting surface by means of incorporated screws (Tmax = 0.8Nm/0.59lbf).
Actuators latch onto the mounting adapter by simple rotation through a Ø22mm/Ø0.87" drilling also on the cover of LPZ control stations.

Contact elements

See page 7-41.
Type: LM2T C10 (1NO)
LM2T CF10 (1NO Faston)
LM2T C10A (1EM)
LM2T C01 (1NC)
LM2T CF01 (1NC Faston)
LM2T C01D (1LB)

Contact elements snap onto the mounting adapter.

The following contacts can be fitted on the mounting adapter on 2-position illuminated buttons:

- Up to 4 contacts when one of the lamp-holders type LM2T DL400, LM2T EL400, LM2T ZL230, LM2T L... or LM2T M... is used (see page 7-40 or 41).
- On the cover of LPZ control station, up to 2 contacts per actuator can be internally fitted, 1 each on the right and/or left, when one of the lamp-holders type LM2T DL400, LM2T EL400, LM2T ZL230, LM2T L... or LM2T M... is used in the middle position.
- Up to 2 contacts when one of the lamp-holders type LM2T YL... or LM2T GL... is used (see page 7-40).

The following contacts can be fitted on the mounting adapter on 3-position illuminated buttons:

- Up to 4 contacts when one of the lamp-holders type LM2T DL400, LM2T EL400, LM2T ZL230, LM2T L... or LM2T M... is used (see page 7-40 or 41).
- On the cover of LPZ control station, up to 2 contacts per actuator can be internally fitted, 1 each on the right and/or left, when one of the lamp-holders type LM2T DL400, LM2T EL400, LM2T ZL230, LM2T L... or LM2T M... is used in the middle position.

NOTE: No lamp-holder type LM2T YL... or LM2T GL... can be used.

Selector switch type of positions

- ↙ Maintained position.
- ↘ Spring return position.

Selector switch rotation angles

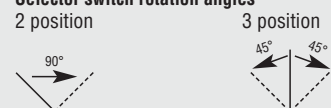

Lamp-holder elements

See page 7-42 and 43.

Lamps

Maximum recommended power: 1.2W.
See page 7-38.

Certifications and compliance

Certifications obtained: UL Listed for USA and Canada, (cULus - File E93601), as Auxiliary Devices; EAC, RINA, LROS, CCC.
Compliant with standards: IEC/EN 60947-1, IEC/EN 60947-5-1, UL508, CSA C22.2 n° 14.

Pilot light heads



8 LM2T IL10...

Order code	Colour	Qty per pkg	Wt
		n°	[kg]
Without mounting adapter.			
8 LM2T IL103	Green	10	0.024
8 LM2T IL104	Red	10	0.024
8 LM2T IL105	Yellow	10	0.024
8 LM2T IL106	Blue	10	0.024
8 LM2T IL107	Transparent	10	0.024
8 LM2T IL1187	Transparent	10	0.024

With symbol indicating dangerous voltage (IEC/EN 60417 5036-a).

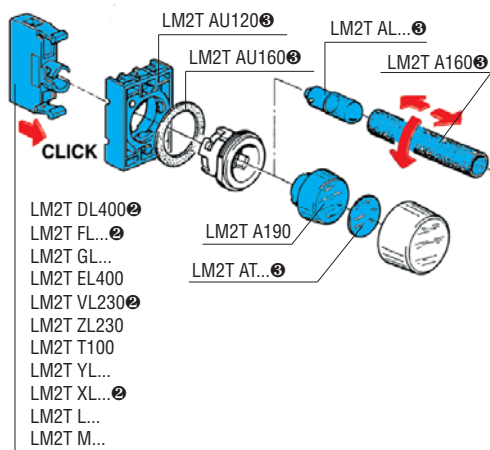

The mounting adapter is supplied with LM2T AU120.

Can be purchased separately. Refer to page 7-38, 7-39 or 42.

Operational characteristics

- Any mounting position allowed
- Ambient conditions:
 - Operating temperature: -25...+60°C
 - Storage temperature: -40...+70°C
- Degree of protection:
 - Per IEC/EN: IP65
 - Per UL: Type 1, 2, 3R, 4, 4X, 12, 12K.

Materials

An aluminium and zinc alloy (zama) is used for the metal part whereas plastic parts are made of polyamide and polycarbonate.

Mounting adapter

See page 7-41.

Type: LM2T AU120.

The adapter is fixed to the mounting surface by means of incorporated screws (Tmax = 0.8Nm/0.59lbf). Pilot light heads latch onto the mounting adapter by simple rotation through a Ø22mm/Ø0.87" drilling also on the cover of LPZ control stations and exclusively with one of the following lamp-holders, internally mounted in the middle position: LM2T DL400, LM2T EL400, LM2T ZL230, LM2T L... or LM2T M... for each light head.

Lamp-holder elements

See page 7-42 and 43.

Lamps

Maximum recommended power: 1.2W.

See page 7-38.

Certifications and compliance

Certifications obtained: RINA, LROS, EAC, CCC, UL Listed for USA and Canada (cULus - File E93601), as Auxiliary Devices.

Compliant with standards: IEC/EN 60947-1, IEC/EN 60947-5-1, UL508, CSA C22.2 n° 14.

Potentiometer drives



8 LM2T P100
(with mounting adapter)



8 LM2T P110
(with mounting adapter)

Order code	Characteristics	Qty per pkg	Wt
		n°	[kg]
Complete with mounting adapter.			
8 LM2T P100	With graduated scale	10	0.070
8 LM2T P110	With variable index	10	0.070

Potentiometer not included.

Operational characteristics

- Suitable for potentiometers with 6 and 6.3mm/0.24-0.25" diameter shaft and minimum 40mm/1.6" shaft length
- Ambient conditions:
 - Operating temperature: -25...+60°C
 - Storage temperature: -40...+70°C
- Any mounting position allowed
- Degree of protection: IP65 (warranted by potentiometers with a cylindrical shaft).

Materials

An aluminium and zinc alloy (zama) is used for the metal part whereas plastic parts are made of polyamide and polycarbonate.

Mechanical endurance

Mechanical life: 300,000 cycles.

Mounting adapter

Standard supply with actuator.

The adapter is fixed to the mounting surface by means of incorporated screws (Tmax = 0.8Nm/0.59lbf). Operators will latch onto the mounting adapter with a simple twist; not suitable for LPZ control stations.

Certifications and compliance

Certifications obtained: EAC, CCC.

Compliant with standards: IEC/EN 60947-1, IEC/EN 60947-5-1.

Joysticks



8 LM2T J...
(without mechanical interlock)



8 LM2T J...
(with mechanical interlock)

Order code	Type of positions	N° auxiliary elements	Qty per pkg	Wt
		NO	n°	[kg]
Without mechanical interlock. Complete with auxiliary contact. Label holder excluded.				
8 LM2T J200		2	1	0.082
8 LM2T J201		2	1	0.082
8 LM2T J400		4	1	0.104
8 LM2T J401		4	1	0.104
With mechanical interlock in centre position. Complete with auxiliary contact. Label holder excluded.				
8 LM2T J210		2	1	0.082
8 LM2T J211		2	1	0.082
8 LM2T J410		4	1	0.104
8 LM2T J411		4	1	0.104

Operational characteristics

- Any mounting position allowed
- LM2T J2... types can be used with LPZ control stations
- Ambient conditions:
 - Operating temperature: -25...+60°C
 - Storage temperature: -40...+70°C
- Degree of protection:
 - Per IEC/EN: IP65
 - Per UL: Type 1, 2, 3R, 4, 4X, 12, 12K
 - IP20 for contact elements.

Materials

An aluminium and zinc alloy (zama) is used for the metal parts whereas plastic parts are made of polyamide and polycarbonate. The sealing boot is made of NBR rubber.

Mechanical endurance

Mechanical life: 1,000,000 cycles.

General characteristics of contact elements

Wiping action and dual scraping-oscillating effect.
IEC rated insulation voltage: 690V
IEC rated thermal current Ith: 10A
UL/CSA and IEC/EN 60947-5-1 designation: A300 Q300.
IEC/EN operational characteristics in AC15 category:

[V]	12	24	48	120	240
[A]	6	6	6	6	3

IEC/EN operational characteristics in DC13 category:

[V]	12	24	48	125	250
[A]	0.55	0.55	0.55	0.55	0.27

Short circuit protection fuse, max calibre: 10A gG/SC.

Contact resistance: ≤20mΩ.

Terminals: Clamp screw with washer

Maximum tightening torque: 1Nm/0.74lbf.

Mounting adapter and contact elements

The joystick is standard supplied with the mounting adapter and contact elements.

The adapter is fixed to the mounting surface by means of incorporated screws (Tmax = 0.8Nm/0.59lbf).

The joystick latches onto the mounting adapter by simple rotation.

Contact elements snap onto the mounting adapter.

Two LM2T CJ... contacts are mounted on joystick LM2T J2... type and 4 LM2T CJ... contacts on LM2T J4... type.

The mounting adapter and contact elements of LM2T J2... types can be internally mounted on LPZ control stations covers.

Certifications and compliance

Certifications obtained: CCC, EAC, UL Listed for USA and Canada (cULus - File E93601), as Auxiliary Devices.

Compliant with standards: IEC/EN 60947-1,

IEC/EN 60947-5-1, UL508, CSA C22.2 n° 14.

Accessories

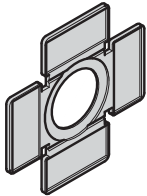

8 LM2T AU101

Order code	Description	Qty per pkg	Wt
		n°	[kg]
8 LM2T AU101	2-4 directional holder for adhesive legends	10	0.004

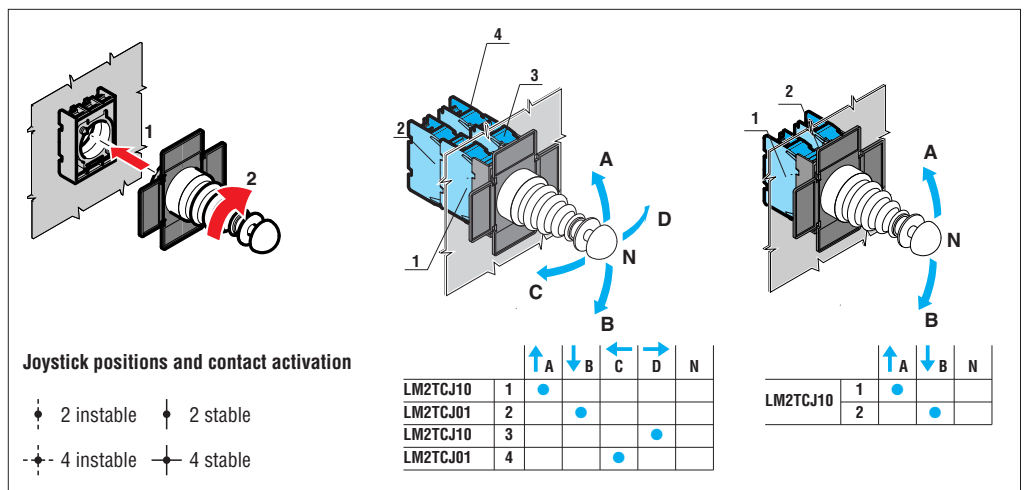
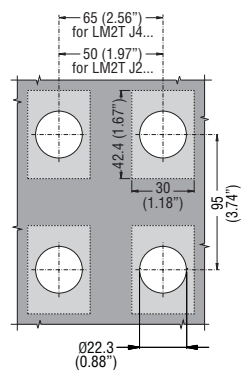

Accessories and spare parts

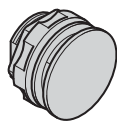

8 LM2T A130



8 LM2T A140

7

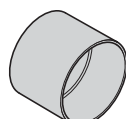

8 LM2T A185



8 LM2T AL...

Order code	Description	Qty per pkg	Wt
		n°	[kg]
8 LM2T A12...①	Coloured diffuser for double touch buttons	10	0.001
8 LM2T A130	Threaded plug for unused drilled holes (black)	10	0.007
8 LM2T A140	Action plug for centre contact	50	0.001
8 LM2T A150	Rod for mechanical reset button (l=140mm/5.5")	10	0.006
8 LM2T A160	BA9s bulb extractor	10	0.004
8 LM2T A161	Hole size adapter set for Ø30mm/1.2" to 22mm/0.87" (2 per hole)	10	0.002
8 LM2T A170	Spare key set for selector or mushroom head button	1	0.008
8 LM2T A170G②	Spare key set for G series selector or mushroom-head button	1	0.008
8 LM2T A185	Selector switch protection shroud for short lever	10	0.004
8 LM2T A190	Diffuser for pilot light	10	0.003
8 LM2T ALA024	Filament bulb BA9s 24VAC/DC - 1.2W	100	0.002
8 LM2T ALB024	Filament bulb BA9s 24VAC/DC - 2W	100	0.003
8 LM2T ALB048	Filament bulb BA9s 48VAC/DC - 2W	100	0.003
8 LM2T ALB130	Filament bulb BA9s 130VAC/DC - 2W	100	0.003
8 LM2T ALL006③	LED bulb BA9s 6VAC/DC	10	0.003
8 LM2T ALL024③	LED bulb BA9s 24VAC/DC	10	0.003
8 LM2T ALL048③	LED bulb BA9s 48VAC/DC	10	0.003
8 LM2T ALN130④	Neon bulb ⑤ BA9s 110...125VAC	100	0.003
8 LM2T ALN250④	Neon bulb ⑤ BA9s 220...250VAC	100	0.003
8 LM2T ALP130④	Neon bulb ⑥ BA9s 110...125VAC	100	0.003
8 LM2T ALP250④	Neon bulb ⑥ BA9s 220...250VAC	100	0.003

- ① Complete the order code by adding the digit of the selected colour: 3 (green); 4 (red); 5 (yellow); 6 (blue); 7 (transparent); 8 (white).
- ② Versions with different key code. Complete with the numeric code of the key. The following versions are available: 501; 502; 503; 504; 505; 506; 507; 508; 509; 510. Example of complete code: 8 LM2T A170G505. Coloured key versions are available on request; consult Customer Service; see contact details on inside front cover.
- ③ Add the digit of the selected colour: 3 (green); 4 (red); 5 (yellow). It is advisable to use the same colour of bulb as of the actuator to obtain adequate light emission.
- ④ Neon bulbs emit an amber light and may not be suitable for use with green or blue pilot lights and illuminated actuators.
- ⑤ Glass with diffuser lens.
- ⑥ Plastic neon bulb.

Accessories and spare parts



8 LM2T AT...



8 LM2T AU100



8 LM2T AU105



8 LM2T AU108
8 LM2T AU106



8 LM2T AU170



8 LM2T AU159



LPX DIN

Order code	Description	Qty per pkg. n°	Wt [kg]
8 LM2T AT...①	Printed label to be inserted in pilot lights and illuminated pushbuttons	50	0.001
8 LM2T AU100②	Legend holder	50	0.001
8 LM2T AU105②	Legend holder (for 8 LM2T AU106 paper or 8 LM2T AU108 plastic labels)	50	0.003
8 LM2T AU106	Blank paper label for writing (for LM2T AU105)	50	0.002
8 LM2T AU107	Transparent protection for LM2T AU106 label	50	0.001
8 LM2T AU108	Blank plastic label for engraving (for LM2T AU105)	50	0.002
8 LM2T AU13③	IP66 boot for pushbuttons LM2T B1/R1...	10	0.006
8 LM2T AU14③	IP66 boot for pushbuttons LM2T B2/B3//BL2/R2...	10	0.009
8 LM2T AU157	IP66 boot for double and triple buttons (transparent)	10	0.007
8 LM2T AU159	Shroud for buttons 8 LM2T B62/63/65/66..., 8 LM2T BL62...	10	0.010
LPX DIN	Adapter for mounting 8 LM2T... buttons on DIN rail 35mm/1.38" wide (2 modules)	10	0.008
8 LM2T AU167	IP66 protective boot for mushroom head buttons LM2T B62/B63... (transparent)	10	0.012
8 LM2T AU170	Actuator gasket	10	0.006

new

new

- ① Available only on specific request, consult Customer Service; see contact details on inside front cover.
- ② To preserve actuators degree of protection (IP65) place their gasket between legend holder and mounting surface.
- ③ For flush and extended push-buttons, complete the order code by adding the digit of the required colour: 2 (black); 3 (green); 4 (red); 5 (yellow); 6 (blue); 7 (transparent); 8 (white).
For illuminated push-buttons, add only digit 7 (transparent).

Pushbuttons and selector switches

8 LM Ø22mm metal series

Labels with text for LM2T AU100 legend holder



8 LM2T AGB230

7

Order code	Text	Qty per pkg	Wt
		n°	[kg]
General use.			
8 LM2T AU206	Blank for writing	50	0.001
8 LM2T AU207	Sheet with 108 labels for laser printing ^①	1 ^②	0.005
8 LM2T AU208 ^③	Sheet with 108 laser-printed labels ^①	1 ^②	0.005
8 LM2T AI210	LATCH	50	0.001
8 LM2T AI211	OPEN	50	0.001
8 LM2T AI212	STOP	50	0.001
8 LM2T AI213	GENERAL STOP	50	0.001
8 LM2T AI214	STOP RESET	50	0.001
8 LM2T AI215	FORWARD	50	0.001
8 LM2T AI216	CLOSE	50	0.001
8 LM2T AI217	RIGHT	50	0.001
8 LM2T AI218	LOWER	50	0.001
8 LM2T AI219	OFF	50	0.001
8 LM2T AI220	EMERGENCY	50	0.001
8 LM2T AI221	OFF	50	0.001
8 LM2T AI222	REVERSE	50	0.001
8 LM2T AI223	ON	50	0.001
8 LM2T AI237	THERMAL TRIP	50	0.001
8 LM2T AI224	SLOW	50	0.001
8 LM2T AI225	RUNNING	50	0.001
8 LM2T AGB226	RESET	50	0.001
8 LM2T AI226	RESET	50	0.001
8 LM2T AI227	RAISE	50	0.001
8 LM2T AI228	LEFT	50	0.001
8 LM2T AI229	POWER ON	50	0.001
8 LM2T AGB225	START	50	0.001
8 LM2T AGB230	STOP	50	0.001
8 LM2T AGB214	STOP-RESET	50	0.001
8 LM2T AI231	FAST	50	0.001
For selector switches.			
8 LM2T AI232	STOP-START	50	0.001
8 LM2T AI233	AUTO-MAN	50	0.001
8 LM2T AI234	AUTO-O-MAN	50	0.001
8 LM2T AI242	MAN-O-AUTO	50	0.001
8 LM2T AI235	FWD-O-REV	50	0.001
8 LM2T AI236	ON - OFF	50	0.001
8 LM2T AI241	MAN-AUTO	50	0.001
8 LM2T AGB232	STOP-START	50	0.001
8 LM2T AGB236	OFF-ON	50	0.001
International labels for pushbuttons.			
8 LM2T AU200	O	50	0.001
8 LM2T AU201	I	50	0.001
8 LM2T AU202	II	50	0.001
International labels for selector switches.			
8 LM2T AU203	O-I	50	0.001
8 LM2T AU204	I-II	50	0.001
8 LM2T AU205	I-O-II	50	0.001

- ① Recommended use with LM2T AU206 blank label.
- ② Sheet with 108 adhesive labels.
- ③ Complete code with label text required.

General characteristics

The labels have indelible scratch-proof black lettering on metalised grey polycarbonate background (adhesive).

Special versions

Labels in different languages are available. Consult Customer Service; see contact details on inside front cover.

Plastic disk for mushroom head pushbuttons

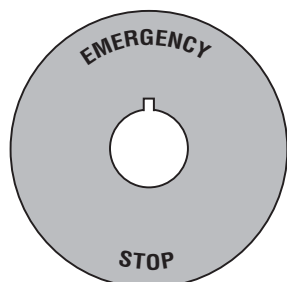

Ordering code	Text	Qty per pkg	Wt
		n°	[kg]
8 LM2T AU112	EMERGENCY STOP Ø90mm/3.5"	10	0.005
8 LM2T AU113	EMERGENCY STOP Ø90mm/3.5"	10	0.005
8 LM2T AU114	EMERGENCY STOP Ø60mm/2.4"	10	0.003
8 LM2T AU115	EMERGENCY STOP Ø60mm/2.4"	10	0.003
8 LM2T AU118	ARRET D'URGENCE / NOT-AUS / PARO EMERGENCIA Ø60mm/2.4"	10	0.003

General characteristics

The disks are made of non-adhesive plastic. It is not possible use plastic disks with protection 8 LM2T AU159.

Special versions

The disk text in different languages is available. Consult Customer Service; see contact details on inside front cover.

Mounting adapter



8 LM2T AU120

Order code	Description	Qty per pkg n°	Wt [kg]
8 LM2T AU120	Mounting adapter	10	0.019

Only for metal series LM2T actuators.

Contact elements

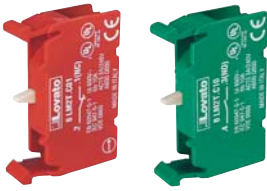

8 LM2T C...



8 LM2T E...



8 LM2T CF01



8 LM2T CF10

Order code	Function	Qty per pkg n°	Wt [kg]
Screw termination. Without mounting adapter			
8 LM2T C10①	NO①	10	0.011
8 LM2T C10A	EM②	10	0.011
8 LM2T C01③	NC③	10	0.011
8 LM2T C01D④	LB④④	10	0.011

Screw termination.
With mounting adapter.

8 LM2T E10①	NO①	10	0.029
8 LM2T E01③	NC③	10	0.029

Faston termination
Without mounting adapter

8 LM2T CF10①	NO①	10	0.012
8 LM2T CF01③	NC③	10	0.012

- ① Use LM2T C10A (EM) or LM2T C01 (NC) type only with push-push actuators. **Not suitable for push-push actuators.**
- ② Normally open contact with early make operation.
- ③ Direct (positive) opening action ⊖ in accordance with IEC/EN 60947-5-1.
- ④ Normally closed contact with late break operation.

Drillings - Minimum recommended distances

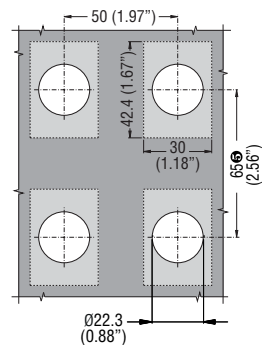

- ⑤ Using contacts with Faston elements, the minimum vertical pitch is 90mm/3.54".

Operational characteristics

- Any mounting position allowed
- The adapter is fixed to the mounting surface by means of incorporated screws ($T_{max} = 0.8Nm/0.59lbf$) also internally on LPZ control stations covers
- Contact elements snap onto the adapter
- Maximum tightening torque for screw terminals: 1Nm
- Ambient conditions:
 - Operating temperature: $-25...+60^{\circ}C$
 - Storage temperature: $-40...+70^{\circ}C$
- Degree of protection:
 - IP20 for contact elements with screw termination
 - IP00 for contact elements with Faston termination.

General characteristics of contact elements

Wiping action and dual scraping and oscillating effect, IEC rated insulation voltage: 690V
IEC rated thermal current Ith: 10A
Conductivity: 5V 10mA.
UL/CSA and IEC/EN 60947-5-1 designation: A600 Q600.
IEC/EN operational characteristics in AC15 category:

[V]	12	24	48	120	240	400	480	500	600
[A]	6	6	6	6	3	1.9	1.5	1.4	1.2

IEC/EN operational characteristics in DC13 category:

[V]	12	24	48	125	250	440	500	600
[A]	3	3	1.5	0.55	0.27	0.15	0.13	0.1

Short-circuit protection fuse: max. calibre 10A gG/GC

Contact resistance: $\leq 20m\Omega$

Terminals: Clamp screw with washer

Faston 1-6.35mm/0.25" or 2-2.8mm/0.11".

Stroke of contact elements

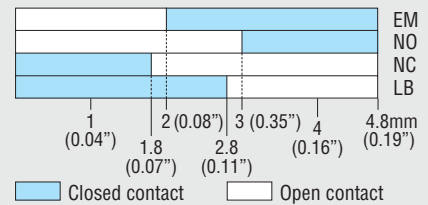

Maximum conductor cross section for screw terminals
1 or 2 2.5mm² or AWG12 cables.

Mechanical and electric endurance

Operating force:	0.5kg / 1.1lb	(contact elements).
Electrical life:	LM2T C10	1,000,000 cycles
	LM2T CF10	1,000,000 cycles
	LM2T C01	1,000,000 cycles
	LM2T CF01	1,000,000 cycles
	LM2T C10A	600,000 cycles
	LM2T C01D	600,000 cycles.

Certifications and compliance

Certifications obtained: RINA, LR0S, EAC, CCC, UL Listed, for USA and Canada (cULus - File E93601), as Auxiliary Devices.

Compliant with standards: IEC/EN 60947-1, IEC/EN 60947-5-1, UL508, CSA C22.2 n° 14.

Lamp-holder elements without mounting adapter



8 LM2T EL400
8 LM2T ZL230



8 LM2T YL...
8 LM2T GL...

Order code	Rated supply voltage	Type of bulb supplied	Qty per pkg	Wt
	[V] 50/60Hz		n°	[kg]
Direct supply.				
8 LM2T EL400	≤415VAC/DC	No	10	0.011
With resistor and diode.				
8 LM2T ZL230	230VAC	Yes 130V (2W)	10	0.015
With transformer.				
8 LM2T YL110	110...120VAC	Yes 24V (1.2W)	1	0.086
8 LM2T YL230	220...240VAC	Yes 24V (1.2W)	1	0.084
8 LM2T YL400	380...415VAC	Yes 24V (1.2W)	1	0.087
Flashing.				
8 LM2T GL048	24...48VAC	No	1	0.027
8 LM2T GL230	110...230VAC	No	1	0.027

Operational characteristics

- Operating supply voltage limits for all types: -15...+10% Ue
- Any mounting position allowed
- The adapter is fixed to the mounting surface by means of incorporated screws (Tmax = 0.8Nm/0.59lbf) also internally on LPZ control stations covers
- Lamp-holder elements snap onto the adapter
- Only lamp-holder elements LM2T DL400, LM2T EL400, LM2T T100 and LM2T ZL230 can be used with LPZ control stations
- Maximum tightening torque: 1Nm/1.57lbf
- Ambient conditions:
 - Operating temperature: -25...+60°C
 - Storage temperature: -40...+70°C
- Degree of protection: IP20.

Mounting adapter

See page 7-41.

Type : LM2T AU120 for LM2T EL400, LM2T ZL230, LM2T YL..., LM2T GL... and/or LM2T T100.

Maximum conductor cross section

1 or 2 2.5mm² or AWG 12 cables.

Wiring diagrams

Direct supply

LM2T EL400
LM2T DL400



With resistor and diode

LM2T ZL230



With transformer

LM2T YL...



Flashing

LM2T GL...



Test element

LM2T T100



Lamp-holder elements with mounting adapter



8 LM2T DL400

Order code	Rated supply voltage	Type of bulb supplied	Qty per pkg.	Wt
	[V] 50/60Hz		n°	[kg]
Direct supply.				
8 LM2T DL400	≤415VAC/DC	No	10	0.029

Test element for lamp-holders without mounting adapter



8 LM2T T100

Order code	Description	Qty per pkg.	Wt
		n°	[kg]
Test element for lamp-holders.			
8 LM2T T100	Test element 507	10	0.011

- Filament bulb, BA9s U≤130VAC/DC max 2.6W (not supplied); maximum dimensions 11x28 mm.
For higher voltages, use neon bulbs.
- Not suitable for 3-position selectors.
- Filament bulb, BA9s (not supplied); maximum dimensions 11x28mm/0.4x1.1".
Use bulbs with rated voltage equal to that of the power supply.
Suitable for AC duty only.
E.g.: With 8 LM2T FL230, use 110VAC bulbs if power supply is 110VAC and 230VAC bulbs if power supply 230VAC. 2.6W max bulb rating.
- Multiled bulbs must not be fitted.
- In case of test circuits for lamp-holders having load in parallel, two LM2T T100 elements are required for each bulb.
Refer to the wiring diagram attached to the product or consult Customer Service; see contact details on inside front cover.
- In case of neon bulbs, consult Customer Service; see contact details on inside front cover.
- Only use with lamp-holder elements:
 - With direct supply
 - With resistor and diode
- Not suitable for use with test element.

Certifications and compliance

Certifications obtained: RINA, LROS, GOST, CCC, UL Listed for USA and Canada (cULus - File E93601), as Auxiliary Devices.
Compliant with standards: IEC/EN 60947-1, IEC/EN 60947-5-1, UL508, CSA C22.2 n° 14.

LED elements steady light



8 LM2T L...

Order code	Supply voltage	LED colour	Qty per pkg.	Wt
	[V]		n°	[kg]

Screw termination.
Supplied without mounting adapter.

8 LM2T LB3	12...30VAC/DC	Green	10	0.016
8 LM2T LB4		Red	10	0.016
8 LM2T LB5		Yellow	10	0.016
8 LM2T LB6		Blue	10	0.016
8 LM2T LB8		White	10	0.016
8 LM2T LE3	85...140VAC	Green	10	0.016
8 LM2T LE4		Red	10	0.016
8 LM2T LE5		Yellow	10	0.016
8 LM2T LE6		Blue	10	0.016
8 LM2T LE8		White	10	0.016
8 LM2T LM3	185...265VAC	Green	10	0.016
8 LM2T LM4		Red	10	0.016
8 LM2T LM5		Yellow	10	0.016
8 LM2T LM6		Blue	10	0.016
8 LM2T LM8		White	10	0.016

① Only LM2T LB... type is suitable for use with LM2T T100 test element.

LED elements flashing light



8 LM2T M...

Order code	Supply voltage	LED colour	Qty per pkg.	Wt
	[V]		n°	[kg]

Screw termination.
Supplied without mounting adapter.

8 LM2T MB3	18...30VAC/DC	Green	10	0.016
8 LM2T MB4		Red	10	0.016
8 LM2T MB5		Yellow	10	0.016
8 LM2T MB6		Blue	10	0.016
8 LM2T MB8		White	10	0.016
8 LM2T ME3	85...140VAC	Green	10	0.016
8 LM2T ME4		Red	10	0.016
8 LM2T ME5		Yellow	10	0.016
8 LM2T ME6		Blue	10	0.016
8 LM2T ME8		White	10	0.016
8 LM2T MM3	185...265VAC	Green	10	0.016
8 LM2T MM4		Red	10	0.016
8 LM2T MM5		Yellow	10	0.016
8 LM2T MM6		Blue	10	0.016
8 LM2T MM8		White	10	0.016

② Only LM2T MB... type is suitable for use with LM2T T100 test element.

Operational characteristics

- Rated frequency: 50-60Hz
- Supply voltage:
 - Steady light: 12...30VAC/DC; 85...140VAC; 185...265VAC
 - Flashing light: 18...30VAC/DC; 85...140VAC; 185...265VAC
- Maximum consumption:
 - Steady and flashing light: 17mA-0.50W (12...30VAC/DC); 20mA-0.40W (85...140VAC); 18mA-0.55W (185...265VAC)
- Protection:
 - Against overvoltages
 - Against stray currents in wiring
 - To reduce flickering phenomenon
 - To withstand vibrations
- Minimum activation voltage:
 - Steady light: 4V-1mA (12...30VAC/DC); 30V-4mA (85...140VAC); 55V-4mA (185...265VAC)
 - Flashing light: 5V-1.5mA (18...30VAC/DC); 13V-1.5mA (85...140VAC); 25V-1.5mA (185...265VAC)
- Electrical life: 100,000 hours
- Snap onto 8 LM2T AU120 mounting adapter in the middle position for each illuminated actuator, also internally on the LPZ control station cover
- No other element can be stacked behind LED elements
- Any mounting position allowed
- Maximum tightening torque: 1Nm
- Ambient conditions:
 - Operating temperature: -25...+60°C
 - Storage temperature: -40...+85°C
- Degree of protection: IP20.

Mounting adapter

See page 7-39. Type: LM2T AU120.
The adapter is fixed on the mounting surface by means of incorporated screws (Tmax=0,8Nm/0.59lbf).

Maximum conductor cross section

1 or 2 2.5mm² or AWG12 cables.

Wiring diagram



Certifications and compliance

Certifications obtained: EAC, CCC, UL Listed for USA and Canada (cULus - File E93601), as Auxiliary Devices.
Compliant with standards: IEC/EN 60947-1, IEC/EN 60947-5-1, UL508, CSA C22.2 n° 14-95.

COMBINATIONS FOR METAL SERIES PUSHBUTTONS AND SELECTOR SWITCHES

SPRING-RETURN BUTTONS

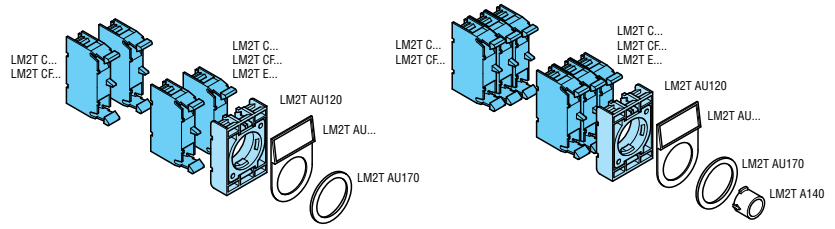

PUSH-PUSH BUTTONS

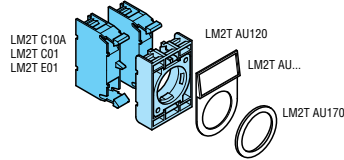
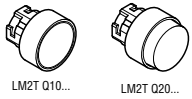

NORMAL STOPPING MUSHROOM-HEAD BUTTONS

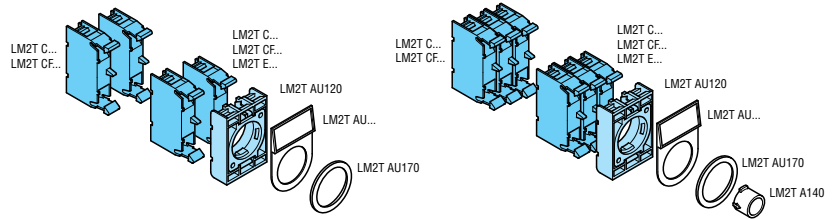
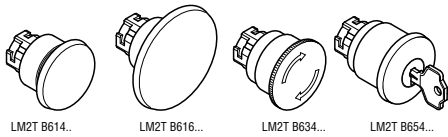

MUSHROOM-HEAD LATCH BUTTONS

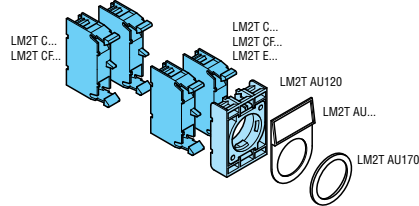
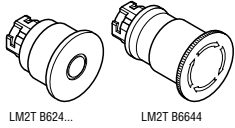

DOUBLE-TOUCH BUTTONS

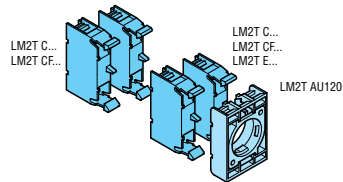
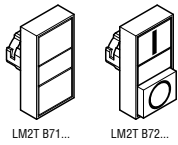

TRIPLE-TOUCH BUTTONS

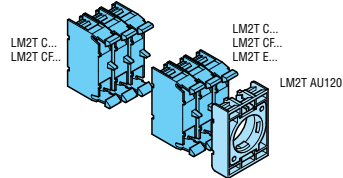
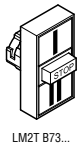

SELECTOR SWITCHES

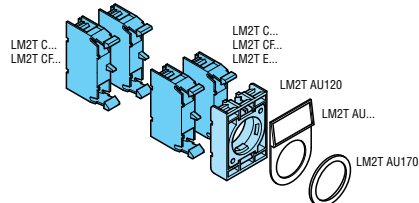
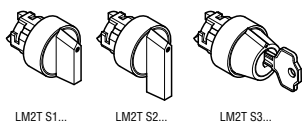

7

COMBINATION FOR METAL SERIES ILLUMINATED PUSHBUTTONS AND SELECTOR SWITCHES

SPRING-RETURN BUTTONS

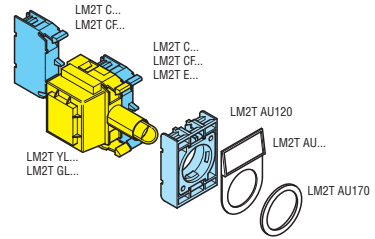
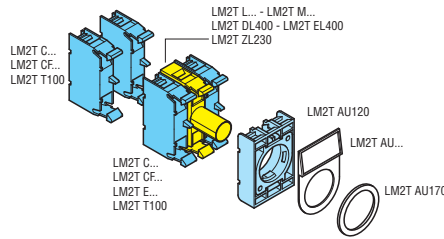
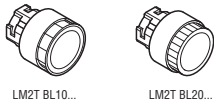

PUSH-PUSH BUTTONS

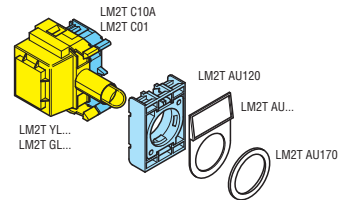
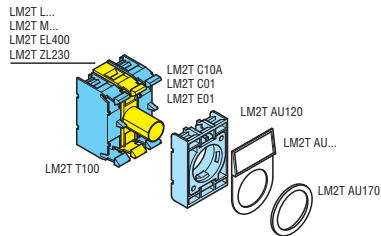

MUSHROOM-HEAD SPRING-RETURN BUTTON

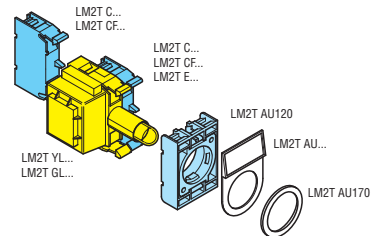
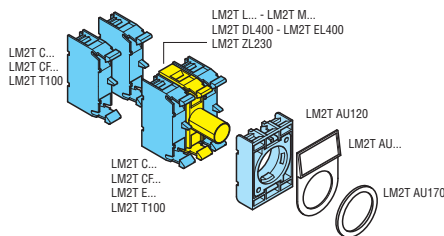
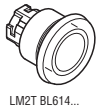

MUSHROOM-HEAD LATCH BUTTON

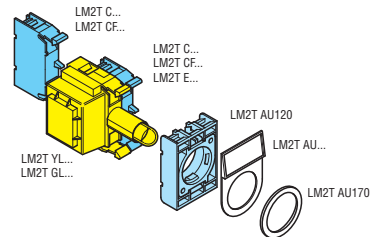
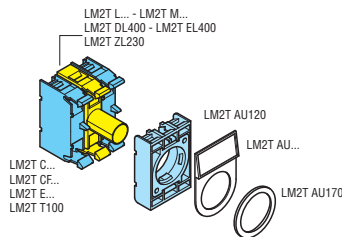
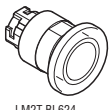

DOUBLE-TOUCH BUTTONS

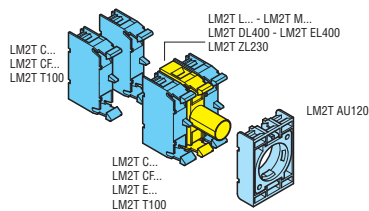
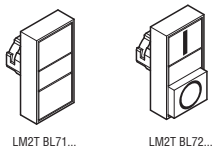

2-POSITION SELECTOR SWITCHES

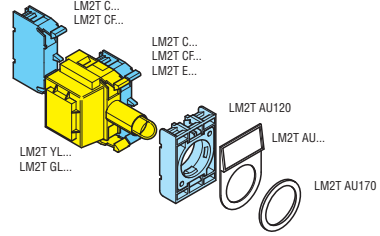
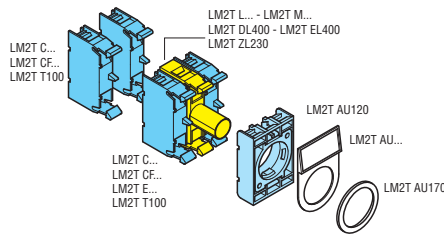

3-POSITION SELECTOR SWITCHES

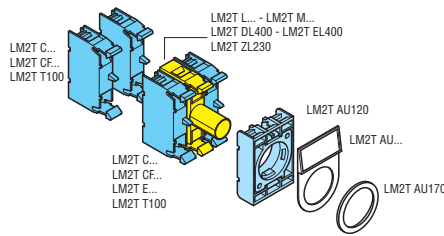

PLATINUM SERIES PUSHBUTTONS AND SELECTOR SWITCHES

Flush pushbutton with screw terminal contact or LED or test elements

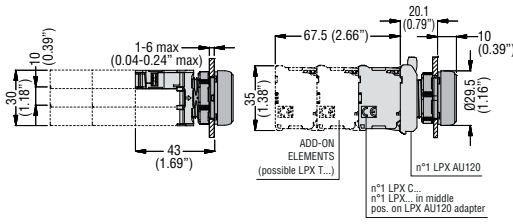

Flush pushbutton with Faston contact elements

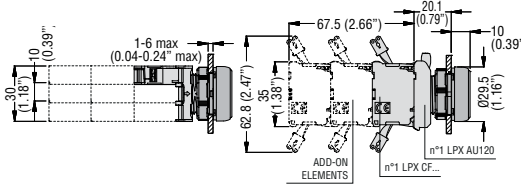

Drillings - Minimum recommended distances

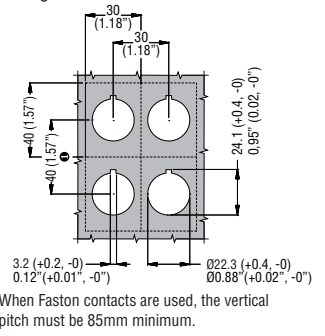

Mushroom-head pushbutton with auto-monitor contacts

LPX C01SM

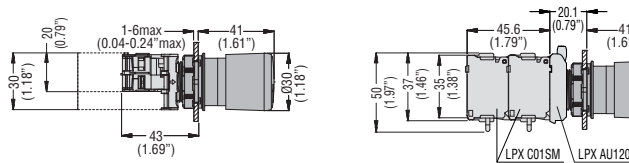

LPX C02SM

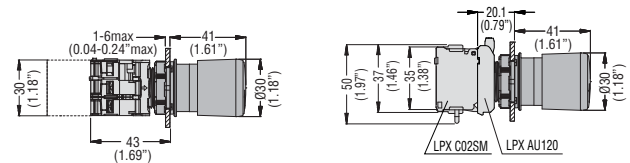

Flush pushbutton with test element and spring-clamp terminal contact or LED elements LPX CS... - LPX LPS...

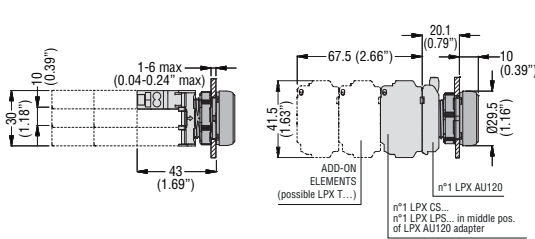

Drillings - Minimum recommended distances with spring-clamp terminal contact or LED elements

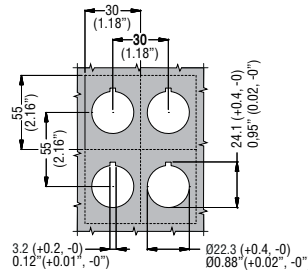

Spring-return and push-push buttons

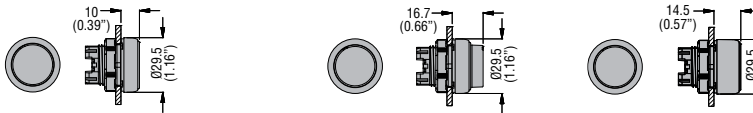

Flush
LPC B1...
Illuminated flush
LPC BL1...
LPC B0

Push-push
LPC Q1...
Illuminated push-push
LPC QL1...

Extended
LPC B2...
Illuminated extended
LPC BL2...

Push-push
LPC Q2...
Illuminated push-push
LPC QL2...
LPC QL0

Shrouded
LPC B30...
LPC B3

Complete with cap or lens.

Mechanical buttons

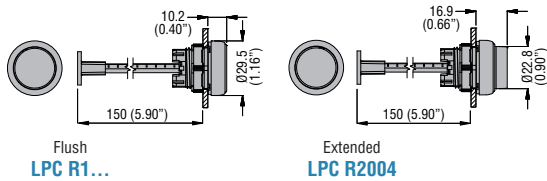

Flush
LPC R1...

Extended
LPC R2004

Mushroom-head button actuators

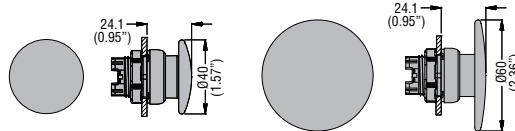

Spring return
LPC B614...
Illuminated spring return
LPC BL614...

Spring return
LPC B616...

Mushroom-head latch button actuators

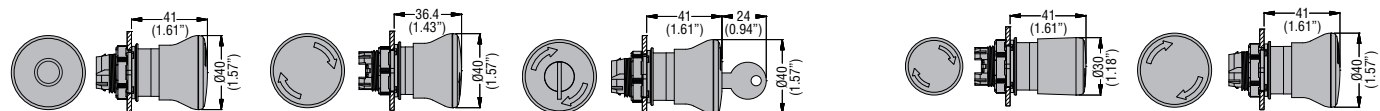

Push-pull
LPC B674...

Turn to release
LPC B634...

Turn key to release
LPC B684...

Turn to release
LPC B6634

Turn to release
LPC B6644
Illuminated turn to release
LPC BL664...

Selector switch actuators

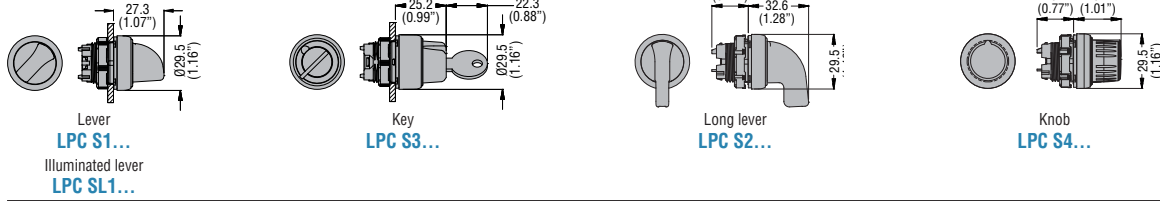

Flush double-touch buttons with or without light indicator

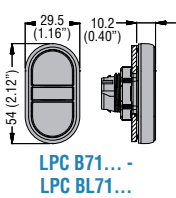

Double-touch buttons with an extended button with or without light indicator

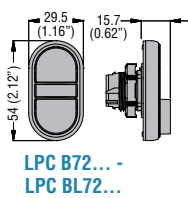

Triple-touch button with middle extended button

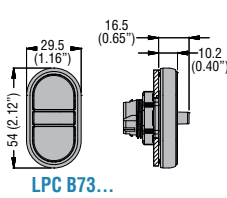

Drillings - Minimum recommended distances

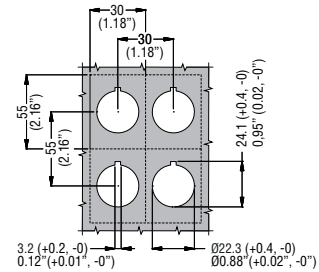

Pilot light head

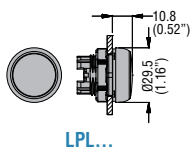

LED-integrated monoblock pilot lights

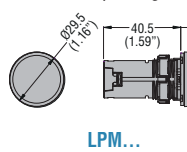

Monoblock buzzers

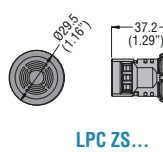

Monoblock potentiometer

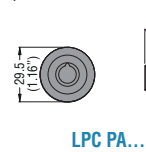

Communication interfaces LPC D...

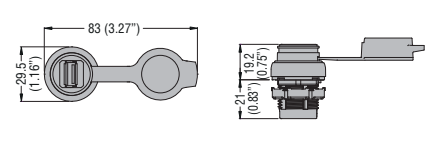

Threaded plug for unused drilled holes

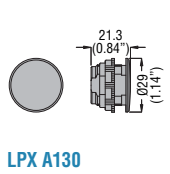

Knob selector switch protection



Label holder

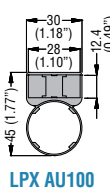

Label

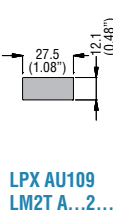

Label holder

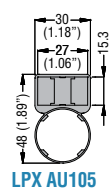

Label

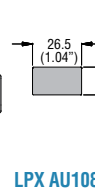

Plastick disk for mushroom-head pushbuttons

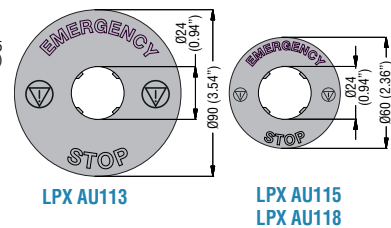

Rubber boot for flush buttons

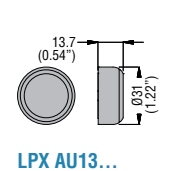

Rubber boot for extended buttons

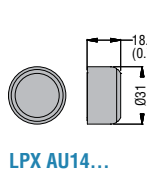

Double/triple button boot

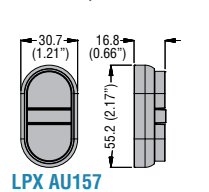

Rubber boot for mushroom-head buttons

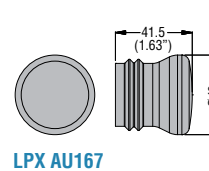

Padlockable protection for mushroom-head latch buttons

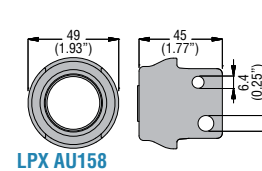

Cable gland

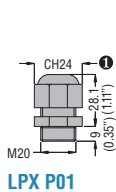

Shroud for mushroom-head latch buttons

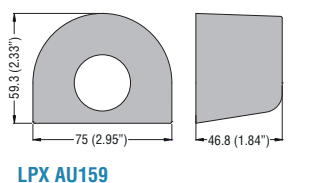

DIN rail adapter

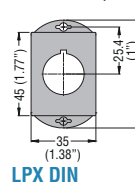

CONTROL STATIONS WITHOUT ACTUATORS

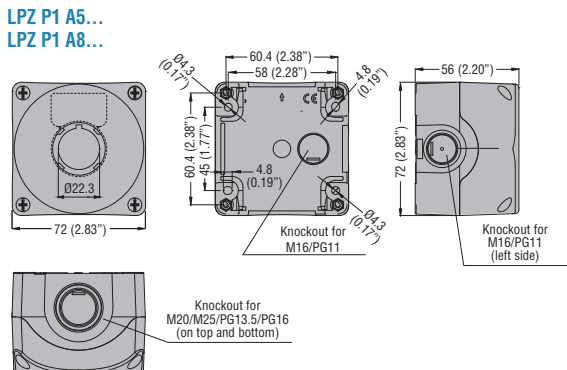

LPZ P2 A5... LPZ P2 A8...

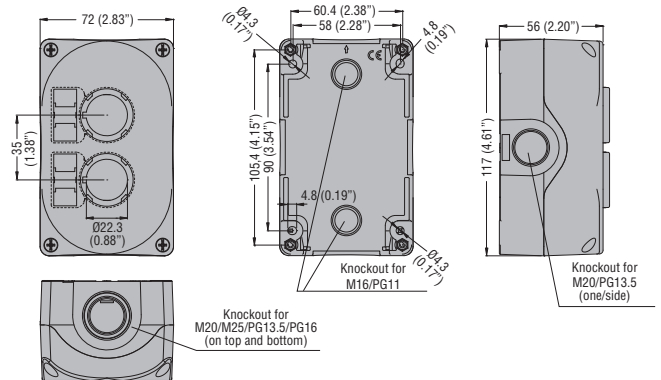

CONTROL STATIONS WITHOUT ACTUATORS

LPZ P3 A8

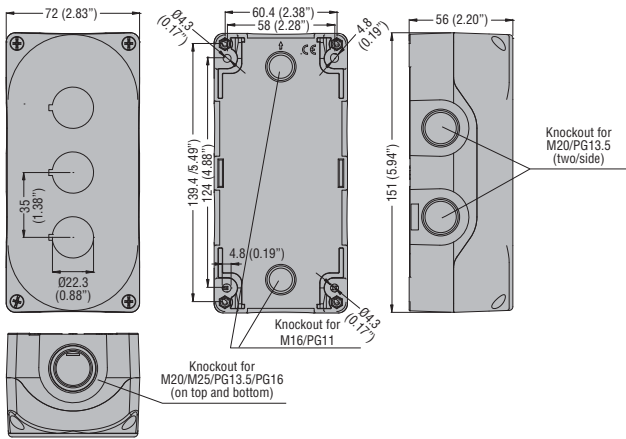

LPZ P4 A8

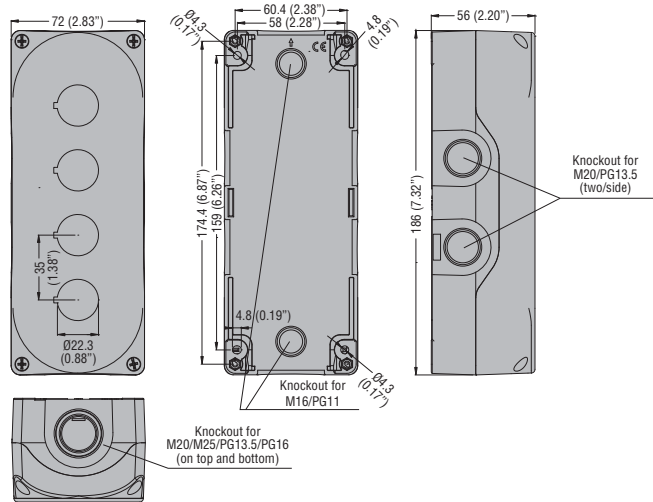

LPZ P5 A8

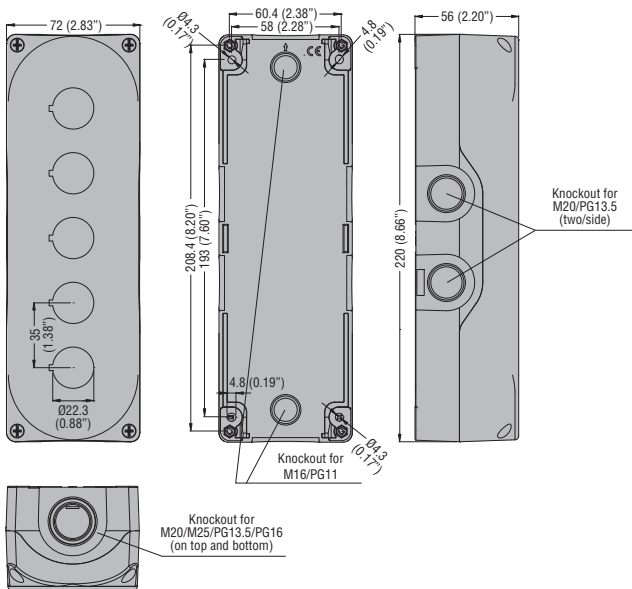

LPZ P6 A8

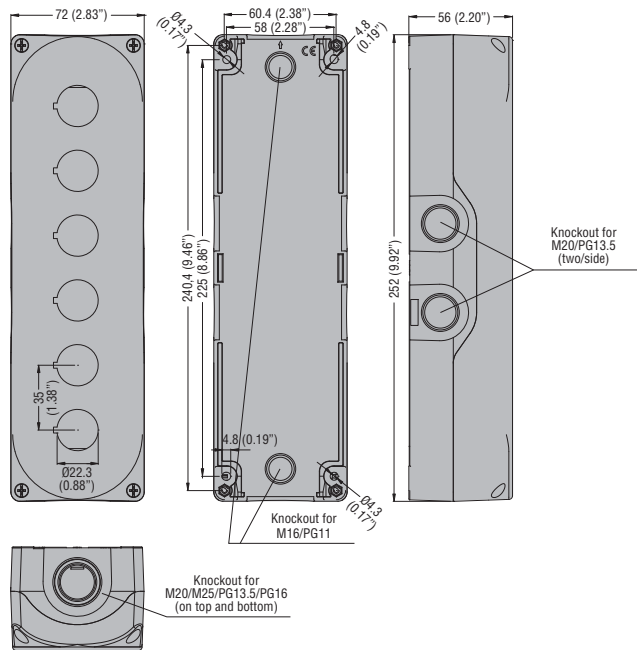

CONTROL STATIONS WITH ONE ACTUATOR

LPZ P1 B8 01

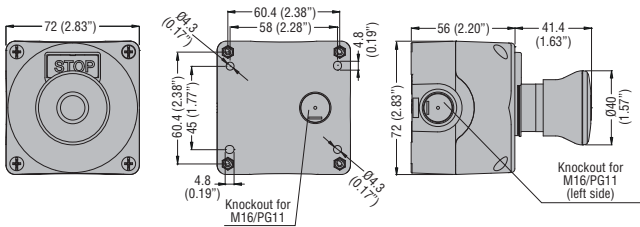

LPZ P1 B8 02

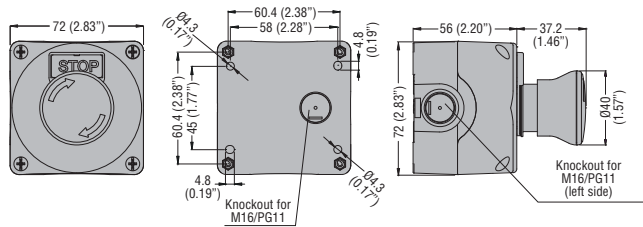

LPZ P1 B5 02

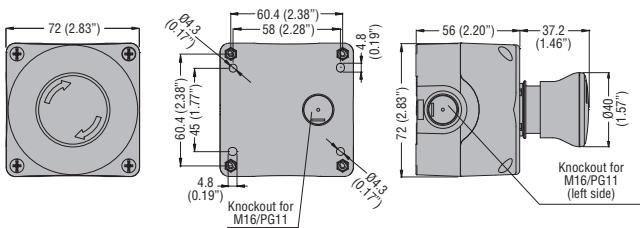

LPZ P1 B5 03

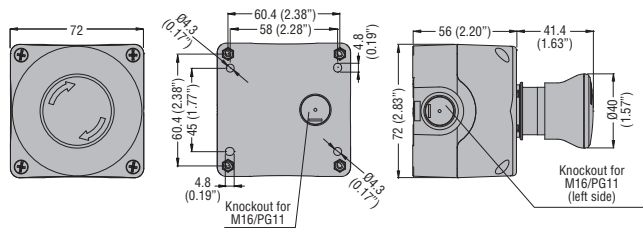

Top view for LPZ P1...

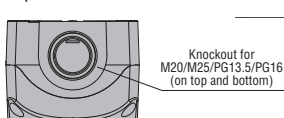

METAL PUSHBUTTONS AND SELECTOR SWITCHES 8 LM SERIES

Flush pushbutton with contact or lamp-holder elements (direct or resistor-diode type) or test element

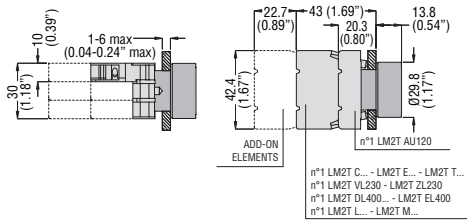

Flush pushbutton with Faston contact elements

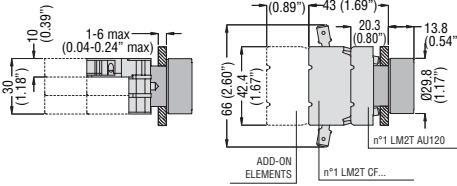

Drillings - Minimum recommended distances

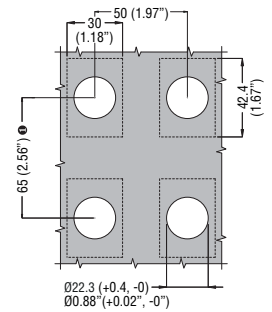

① When Faston contacts are used, the vertical pitch must be 90mm minimum.

Pushbutton actuators

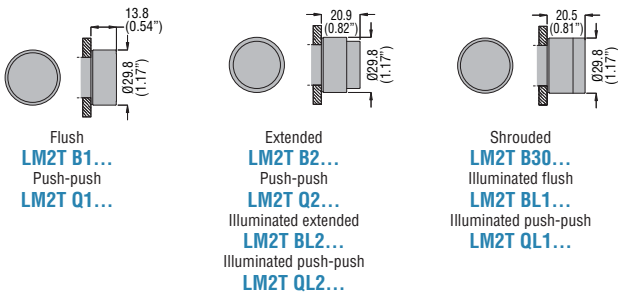

Reset buttons (complete unit)

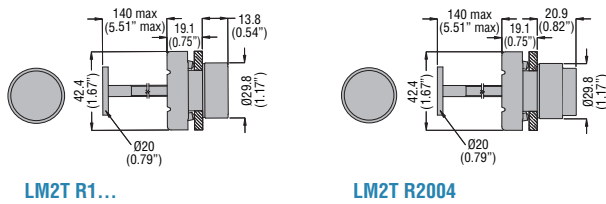

Mushroom-head button actuators

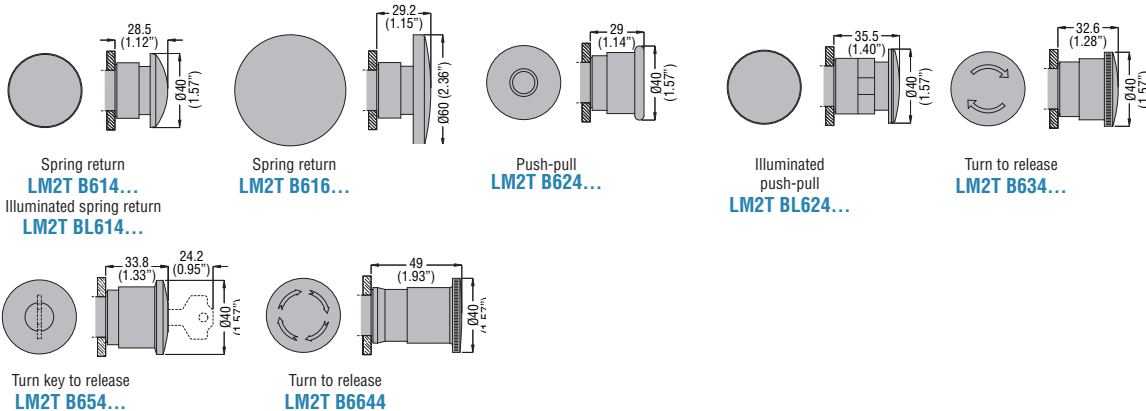

Double-touch actuators with or without indicator
 2 flush buttons

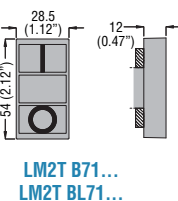

Double-touch actuators with or without indicator
 1 flush and 1 extended button

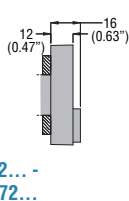

Triple-touch actuators with middle extended button

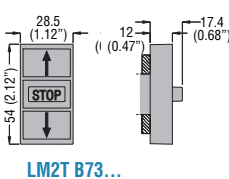

Drillings - Minimum recommended distances

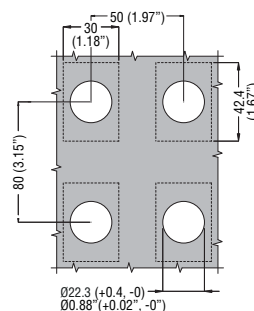

Selector switch actuators

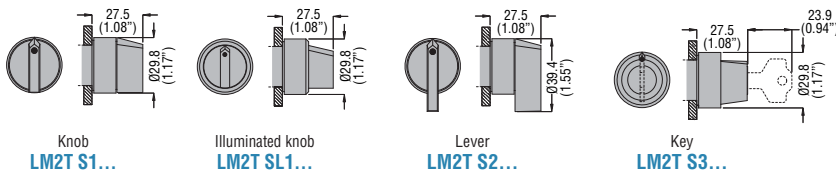

Pilot light head

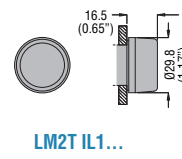

Potentiometer drive

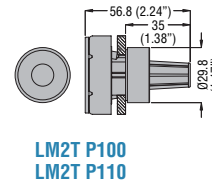

Joystick with free actuation lever

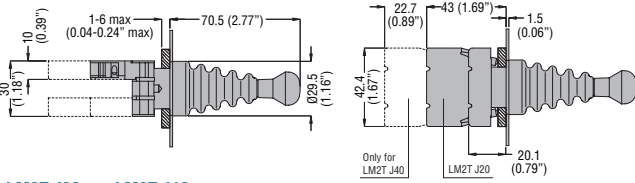

Joystick with mechanical latch lever

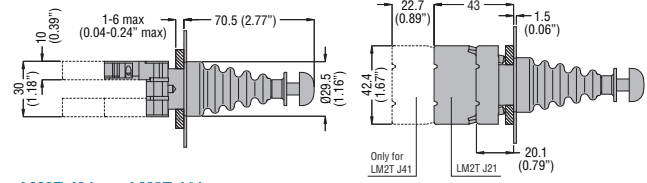

7

LM2T J20... - LM2T J40...

LM2T J21... - LM2T J41...

Label holder

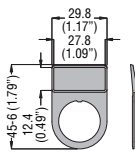

LM2T AU100

Label

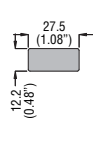

LM2T A...

Label holder

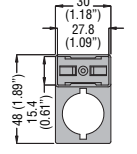

LM2T AU105

Label

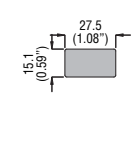

LM2T AU10...

Plastic disk for mushroom-head pushbuttons

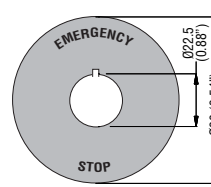

LM2T AU112
LM2T AU113

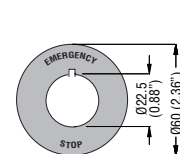

LM2T AU114
LM2T AU115
LM2T AU118

Rubber boot for flush buttons

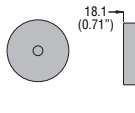

LM2T AU13...

Rubber boot for extended buttons

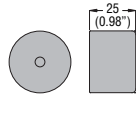

LM2T AU14...

Double/triple button boot



LM2T AU157

Rubber boot for mushroom-head buttons

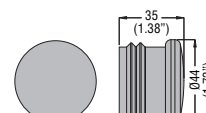

LM2T AU167

Threaded plug for unused drilled holes

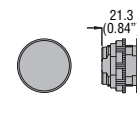

LM2T A130

Knob selector switch protection

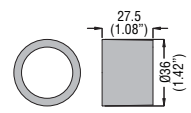

LM2T AU185

Shroud for mushroom-head latch buttons

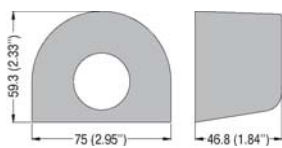

LM2T AU159

DIN rail adapter

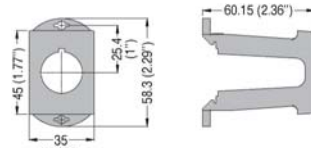

LPX DIN

Lamp-holder elements with direct supply or resistor and diode

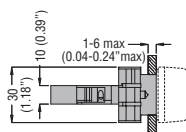

LM2T EL400
LM2T DL400
LM2T ZL230
LM2T VL230

LED steady or flashing light element

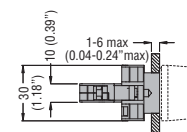

LM2T L... - LM2T M...

Transformer or flashing lamp holder element

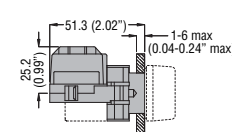

LM2T YL... - LM2T GL...
LM2T XL... - LM2T FL...

FOR PUSHBUTTONS AND SELECTOR SWITCHES

LPX C10 - LPX E10 - LPX CF10
LPX CS10 - LPX CB10
LM2T C10 - LM2T E10

LPX C10A
LM2T C10A

LPX C01 - LPX E01 - LPX CF01
LPX CS01 - LPX CB01
LPZ P1 B... - LM2T C01

LPX C01D
LM2T C01D

LPX C01SM

LPX C02SM

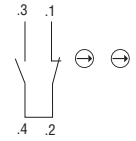
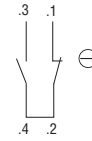
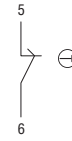
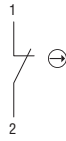

LPM...
LPX L...

LPC ZS...

LPX T100

LPX T101
LPX T102

LPC PA...

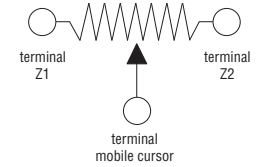
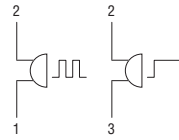

LM2T EL400
LM2T DL400

LM2T ZL230

LM2T YL...

LM2T GL...

LM2T T100

LM2T L...
LM2T M...

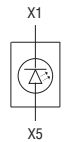
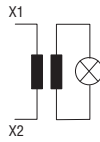
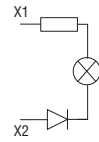

LPC D01

LPC D03

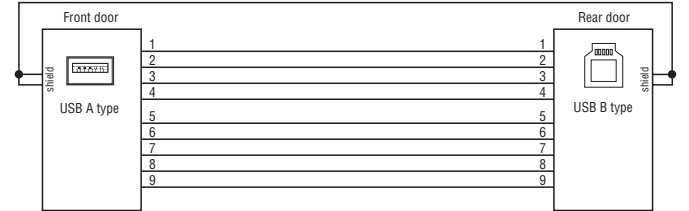
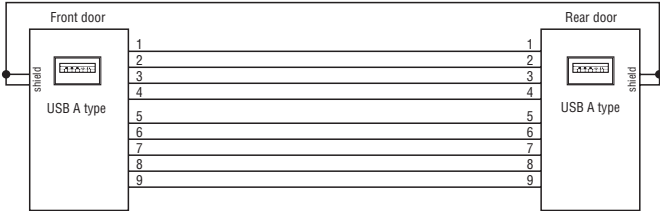

LPC D05

LPC D06

