

Mosaic™ RCA socket outlets

Cat. No(s): 787 52/53/54 - 792 54

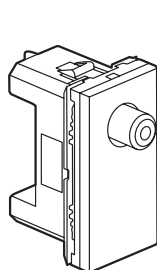

787 52

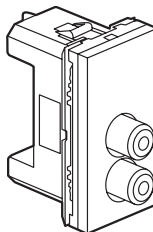

787 53

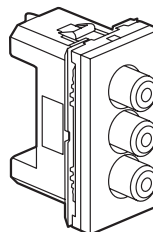

787 54 - 792 54

1. USE

RCA socket outlets with 1 to 3 terminals for audio and/or video connections.

Video audio stereo connection of any peripheral, amplifier, mixing console, DVD player, camera, video tape recorder, video conference equipment, etc.

2. RANGE

	Designation	Cat No.	Modules	Fixing method	Connection method	Weight (g)
	Yellow video RCA socket outlet	787 52	1	With clips	With screws	13.5
	Audio RCA socket outlet (red/white)	787 53	1	With clips	With screws	17.1
	Audio/video RCA socket outlet (red/white/yellow)	787 54	1	With clips	With screws	23.0
	Audio/video RCA socket outlet (red/white/yellow) Aluminium cover plate	792 54	1	With clips	With screws	23.0

3. PREPARATION

- The mechanisms can be flush-mounted or surface-mounted.
- Modular mechanisms using adapter Cat. No. 802 99 (2 modules).
- The mechanisms are mounted on thin walls using adapters Cat. Nos 802 90 (1 module), 802 91 (2 modules), 802 92 (2 x 1 vertical module).

4. OVERALL DIMENSIONS

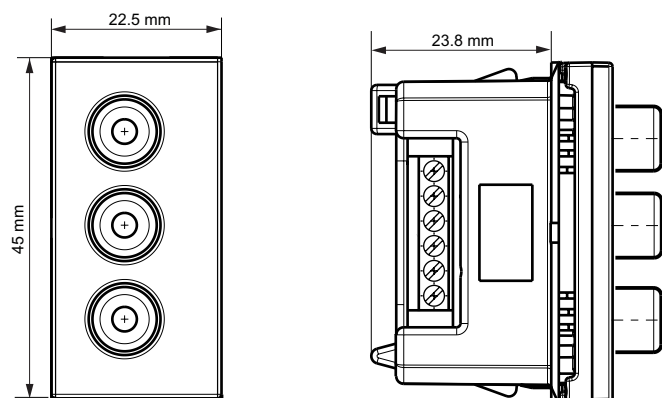

5. CONNECTION

Wide terminal strip taking a max. 1 mm² conductor
Supplied in a bag containing:

- 1 Colring tie
- crimping ferrules for conductor < 0.5 mm²
- thermoformable sheaths

Cable bend radius: 35 mm

Stripping

Audio cable:

Shielded cable 2 x 0.22 mm² or 2 x 0.40 mm².

- a - Cable unsheathing length:
- b - Braid length: 30 mm
Twist the braid
- c - Core stripping length: 6 mm

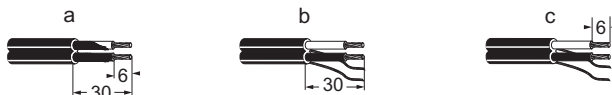

Video cable:

Recommended video cable: 1 coax 75 Ω.

- a - Cable unsheathing length: 30 mm
- b - Braid length: 30 mm
Thin out and twist the braid
- c - Core stripping length: 6 mm

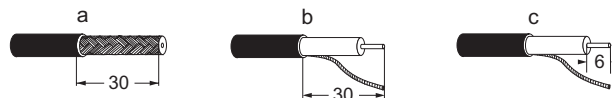

RCA socket outlets

5. CONNECTION *(cont'd)*

Wiring

Tools required: flat-blade screwdriver 0.4 x 2.5 mm and flat-nose pliers.

Insulate the 2 braids using the supplied neoprene sleeve, thread them into their supplied respective ferrules and crimp them using the flat-nose pliers.

Thread the cores into their respective ferrules and crimp them using the flat-nose pliers.

Hold the cable mechanically using the supplied cable clamp.

Comply with the following wiring diagrams:

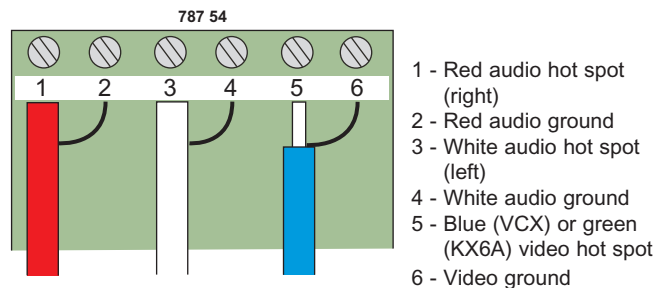
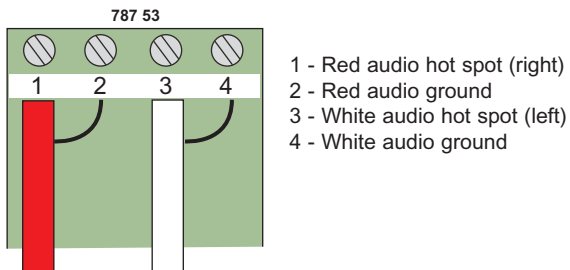
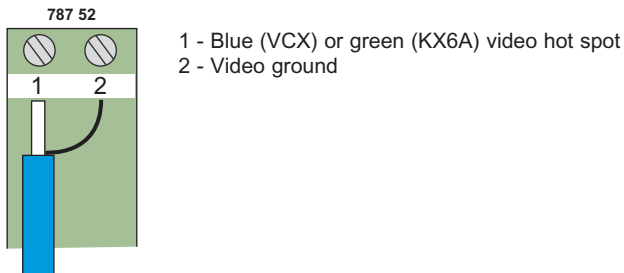

6. TECHNICAL CHARACTERISTICS

6.1 Mechanical characteristics

Impact tests: IK 04

Penetration by solid bodies/liquid: IP 40

6.2 Material characteristics

Base: Polycarbonate

Cover: ABS (RAL 9003)

Self-extinguishing: 650° C / 30 s

6.3 Climatic characteristics

Storage temperatures: - 10° C to + 70° C

Operating temperatures: - 5° C to + 50° C

7. CLEANING

Surface cleaning with a cloth.

Do not use: acetone, tar remover, trichloroethylene.

7.1 Resistance to cleaning agents

Resistance to the following agents: - Hexane (EN 60669-1)

- Methylated spirits

- Soapy water

- Diluted ammonia

- Diluted pure bleach 10%

- Glass cleaning substance

- Pre-impregnated wipes.

7.2 Resistance to hospital-type cleaning agents

Resistance to the following agents: - Anios

- Surfanios

- Bactily sine

- Diluted hydrogen peroxide 35%.

Caution: A preliminary test should be carried out if other specific cleaning products are to be used