

THIS IS A C.A.D. GENERATED DRAWING  
DO NOT MAKE MANUAL REVISIONS TO MASTER.

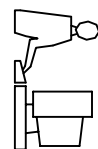

ISSUE NUMBER	
UPDATE DWG TO USE NEW SHELL R.STA.MONICA	AUG.12/2015
DIM: .732[18.60] WAS .756[19.20]	AUG.24/2015
NOTES UPDATED N.SONDH	NOV.26/2015
ADD PACKING ADD EDAC LABEL	R.STA.MONICA FEB.25/2016
UPDATE PACKAGING SPECS	R.STA.MONICA APR.08/2016
ADD ORDERING CODE	R.STA.MONICA APR.08/2016
ADD "EDAC" LOGO	
DIMENSIONS	R.STA.MONICA APR.08/2016
UPDATE DRAWING DIMENSIONS	
C.B.	SEP.08.2016

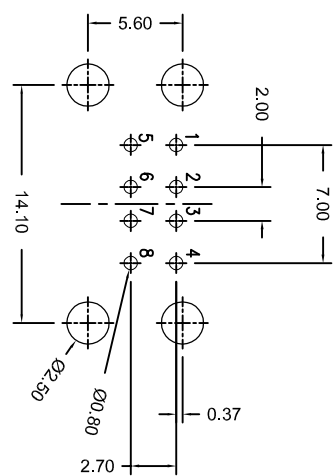
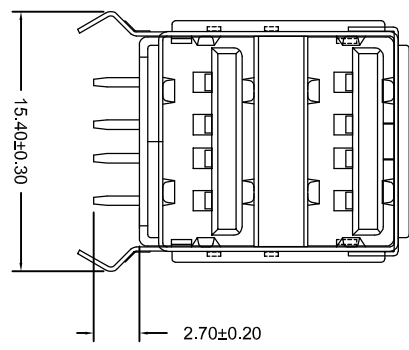
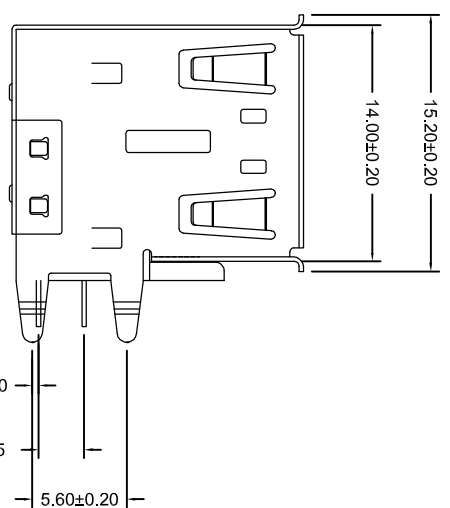
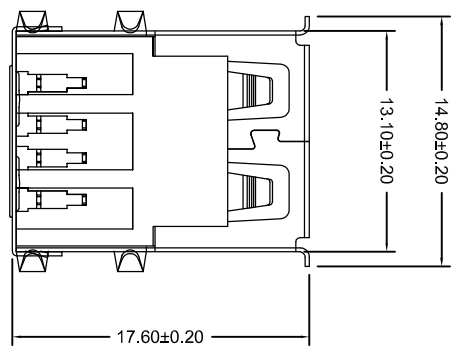

RECOMMENDED P.C.B. LAYOUT  
TOP VIEW, TOLERANCE ±0.10

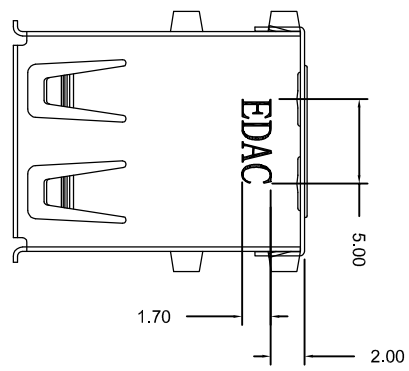

- NOTES:
1. MATERIALS:  
HOUSING: P.B.T. WITH GLASS FIBER  
CONTACT: COPPER ALLOY, PLATED WITH GOLD FLASH ON CONTACT AREA, TIN PLATING ON SOLDER AREA  
ALL OVER NICKEL UNDERPLATING  
SHELL: SPCC, PLATED WITH NICKEL
  2. ELECTRIC:  
CONTACT RESISTANCE: 30 MILLIOHMS MAX.  
INSULATION RESISTANCE: 1000 MEGOHMS MIN  
DWV: 500VAC ONE SEC LEVEL  
TEMPERATURE RANGE: -55°C TO +105°C
  3. ORDERING CODE AS PER PACKAGING SPECS:

**PART NO.**  
690-008-221-904  
690-008-221P904

**PACKAGING**  
USB PLACE VERTICALLY ON TRAY FOR MANUAL OPERATION  
USB PLACE HORIZONTALLY ON TRAY FOR PICK AND PLACE OPERATION



THIS SERIES FULLY CONFORMS TO THE EUROPEAN UNION DIRECTIVES 2011/65/EU ROHS COMPLIANCY.

**CM-USB A TYPE (FEMALE) DIP 90°  
DOUBLE DECK**

**EDAC INC**  
TORONTO, ONTARIO  
CANADA

THESE DRAWINGS AND SPECIFICATIONS ARE THE PROPERTY OF EDAC INC. AND SHALL NOT BE REPRODUCED OR COPIED OR USED AS THE BASIS FOR THE MANUFACTURE OR SALE OF APPARATUS WITHOUT WRITTEN PERMISSION.

ACAD REFERENCE NO.	690-008-221-904
DRAWN: F.BRIONES	DATE: MAY. 05/15
PART NUMBER	
<b>SEE ORDERING CODE</b>	
DRAWING NUMBER	ISSUE
690-008-221-904	9

1 OF 2

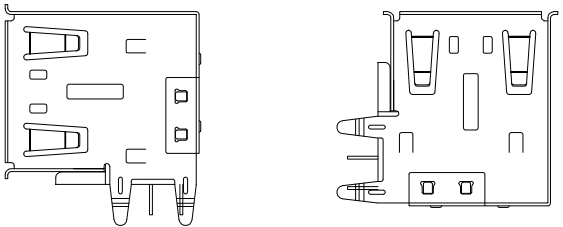

USB PLACE VERTICALLY  
FOR MANUAL OPERATION  
690-008-221-904



USB PLACE HORIZONTALLY  
FOR PICK & PLACE OPERATION  
690-008-221-P904

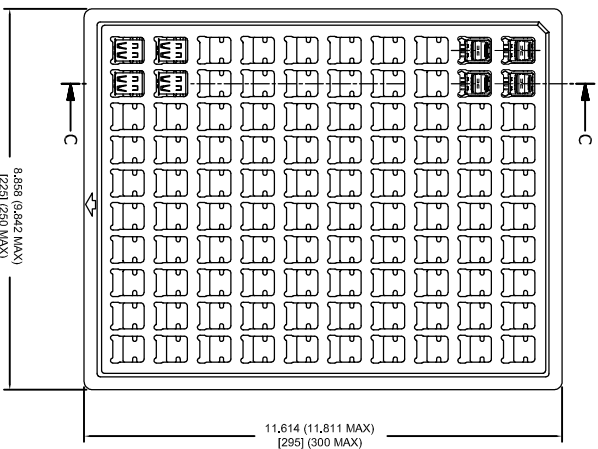
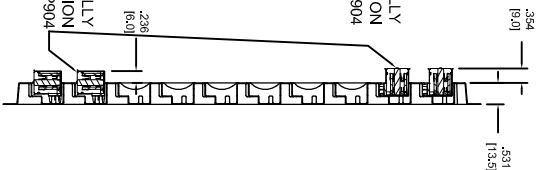

10 TRAY/SHEAF, EACH SHEAF PACKING PRODUCTS  
1000 PCS, PACKED PRODUCTS, 20TRAY/BOX

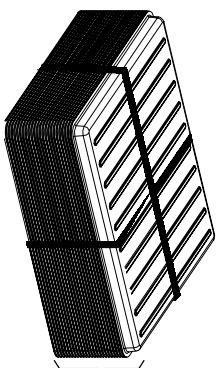
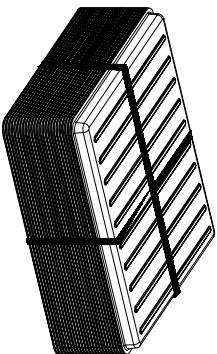
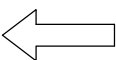

LABEL

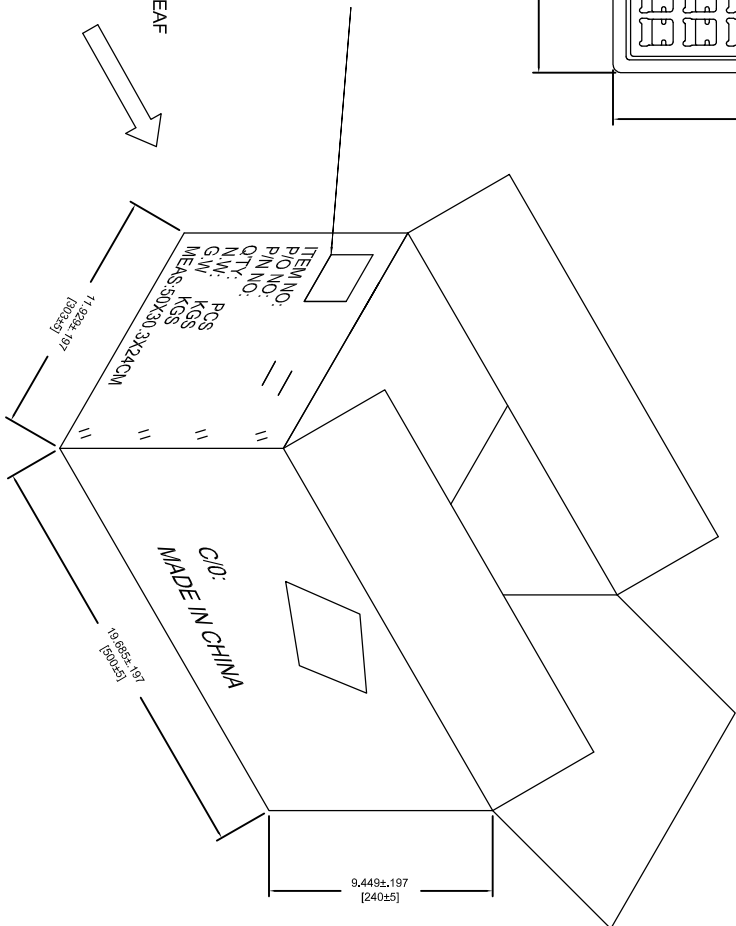

THIS SERIES FULLY CONFORMS TO THE  
EUROPEAN UNION DIRECTIVES 2011/65/EU  
ROHS COMPLIANCY.

**CM-USB A TYPE (FEMALE) DIP 90°  
DOUBLE DECK, PACKAGING**

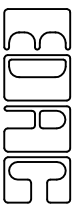

EDAC INC  
TORONTO, ONTARIO  
CANADA

YOUR CONNECTION TO QUALITY & SERVICE

THESE DRAWINGS AND SPECIFICATIONS  
ARE THE PROPERTY OF EDAC INC. AND  
SHALL NOT BE REPRODUCED OR COPIED  
OR USED AS THE BASIS FOR THE  
MANUFACTURE OR SALE OF APPARATUS  
WITHOUT WRITTEN PERMISSION.

ACAD REFERENCE NO. 690-008-221-904

DRAWN: F. BRIONES DATE: MAY. 05/15

PART NUMBER

SEE ORDERING CODE 2 OF 2

DRAWING NUMBER

690-008-221-904

ISSUE

9