

No.	Changes and/or Note No.	Date	Intr	No	Changes and/or Note No.	Date	Intr

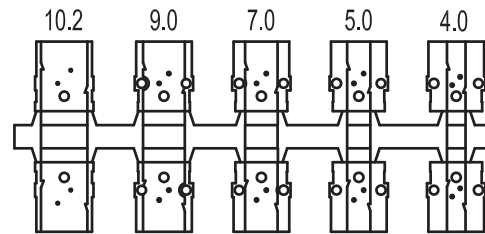
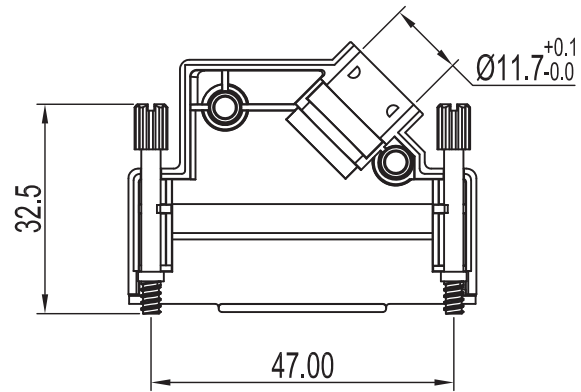
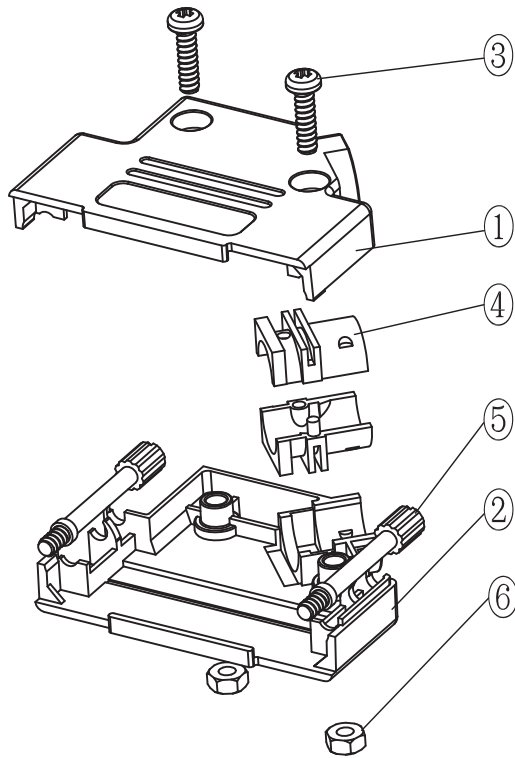
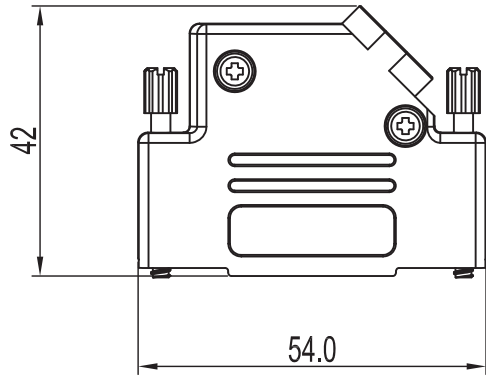

Grommet Set

Part Number:	Description:	Pack:	Item	QTY	Part description
6560-0107-13	D45PK25-P-K	Kit	1	1	D45PK25-Upper cover
6561-0107-13	D45PK25-P	Bulk	2	1	D45PK25-Lower cover
			3	2	M3X11.5 Screw
			4	1	D45ZK-D2 Grommet set
			5	2	UNC 4-40X32.5 Jackscrew
			6	2	M3 Nut
DATE: 2011-04-10	DRAWN: MRR	SCALE:	MATERIAL TYPE:		GENERAL TOLERANCES UNLESS OTHERWISE STATED LINEAR 0 ±0.20 0.0 ±0.15 0.00 ±0.10 ANGULAR ±0°30' ALL DIMENSIONS IN mm THIRD ANGLE PROJECTION
	APPROVED:		REPLACES:		
		D45PK-P-SERIES			
				DRAWING No:	6688-9579