

No.	Changes and/or Note No.	Date	Intr	No	Changes and/or Note No.	Date	Intr

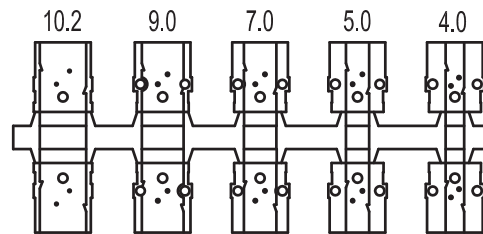
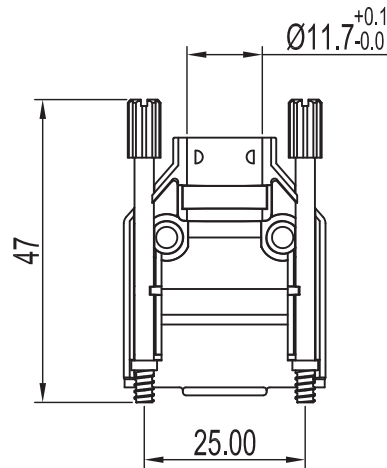
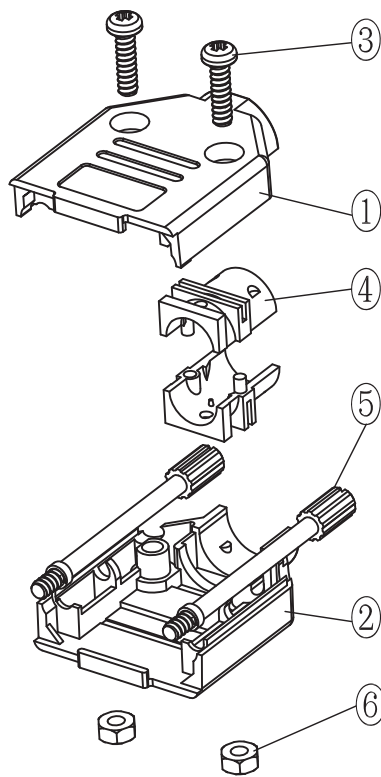
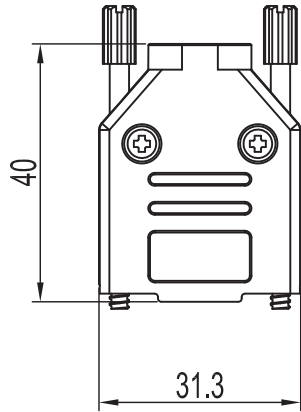

Grommet Set

Part Number:	Description:	Pack:	Item	QTY	Part description
6560-0108-01	DTPK09-P-K	Kit	1	1	DTPK09-Upper cover
			2	1	DTPK09-Lower cover
			3	2	M3X11.5 Screw
6561-0108-01	DTPK09-P	Bulk	4	1	D45ZK-D2 Grommet set
			5	2	UNC 4-40X47 Jackscrew
			6	2	M3 Nut
DATE: 2011-04-10	DRAWN: MRR	SCALE:	MATERIAL TYPE:		GENERAL TOLERANCES UNLESS OTHERWISE STATED LINEAR 0 ±0.20 0.0 ±0.15 0.00 ±0.10 ANGULAR ±0°30' ALL DIMENSIONS IN mm THIRD ANGLE PROJECTION
APPROVED:	REPLACES:				
		<h1>DTPK-P-SERIES</h1>			
				DRAWING No:	6688-9581