



Page 23-8

#### ENERGY METERS

- Single phase, three phase with neutral, three phase with or without neutral
- Direct connection or by current transformers
- MID certified versions
- Versions that can be expanded with EXP... expansion modules
- Versions with built-in RS485 communication port.



Page 23-13

#### DATA CONCENTRATORS

- Energy consumption data storage for network usage
- Connection up to 14 energy meters equipped with static output
- Photovoltaic monitoring type
- Expandable with EXP... expansion modules
- Built-in RS485 communication port.



Page 23-14

#### DIGITAL LCD MULTIMETERS AND POWER ANALYZERS

- Graphic or icon LCD
- Version with touch screen
- Modular and panel mount types
- Remote display
- Versions that can be expanded with EXP... expansion modules.



Page 23-17

#### PORTABLE POWER ANALYZERS

- IP65 casing
- With built-in USB interface
- GPRS/GSM communications
- Available kits of current clamps and cables.



Page 23-18

#### LED MEASURING INSTRUMENTS

- Voltmeters, ammeters, frequency meters, cosphi meters and wattmeters.

#### DIGITAL LED MULTIMETERS

- Basic version, with energy meters, with 2 programmable outputs and built-in RS485 communication port.



Page 23-27

#### CURRENT TRANSFORMERS

- Primary current: 50-4000A
- Secondary current: 5A
- Solid and split-core types
- Instrument and accuracy versions.



- Digital voltmeters, ammeters, wattmeters, frequency meters and cosphi meters
- Digital multimeters and power analyzers, expandable, with graphic LCD
- Connection to single, two, three phase systems
- Ideal for distribution systems, electricity cogeneration and on-board machinery installations.
- High measurement accuracy
- Totally programmable digital outputs
- RS485, RS232, USB, Ethernet, Profibus DP serial interface for remote control and data-logger.

	SEC. - PAGE
<b>Energy meters</b>	
Single phase .....	23 - 8
Single phase, MID certified .....	23 - 9
Three phase with or without neutral .....	23 - 10
Three phase with neutral, MID certified .....	23 - 11
Three phase with or without neutral, UTF certified .....	23 - 12
<b>Data concentrators</b>	
General use .....	23 - 13
For photovoltaic control and supervision .....	23 - 13
<b>Digital metering instruments</b>	
Modular LCD multimeters .....	23 - 14
Flush mount LCD multimeters .....	23 - 16
Flush mount touch-screen LCD power analyzers .....	23 - 17
Flush mount LED measuring instruments .....	23 - 18
Flush mount LED multimeters .....	23 - 20
Modular LED measuring instruments .....	23 - 23
<b>Communication devices, protection covers, accessories</b> .....	23 - 25
<b>Converter gateway, connecting cables</b> .....	23 - 26
<b>Current transformers</b> .....	23 - 27
<b>Dimensions</b> .....	23 - 30
<b>Wiring diagrams</b> .....	23 - 33
<b>Technical characteristics</b> .....	23 - 36

# SYSTEM MANAGEMENT

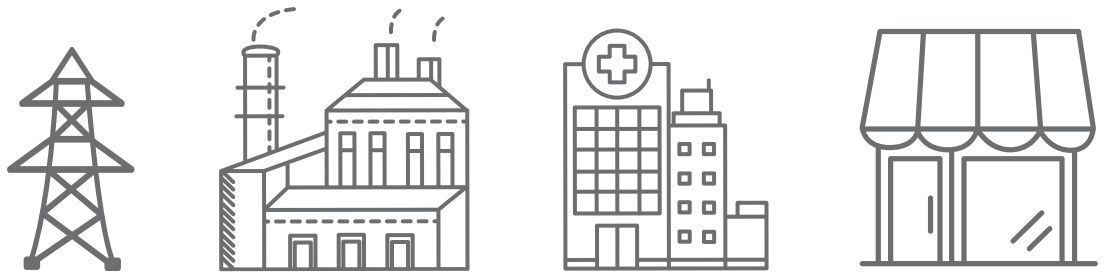

MV/LV transformer room

Primary distribution

Secondary distribution

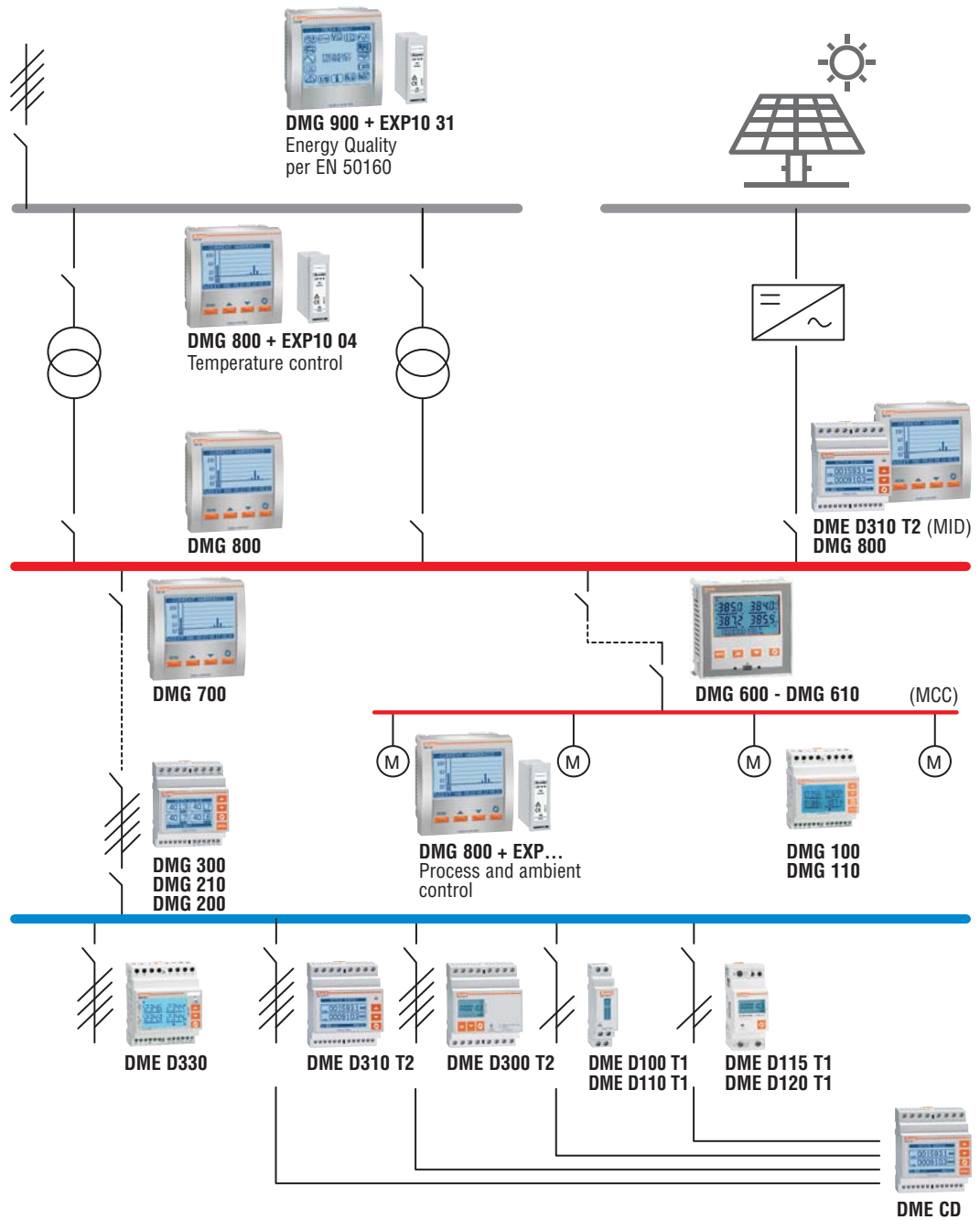

# LOVATO ELECTRIC DEVICE MONITORING

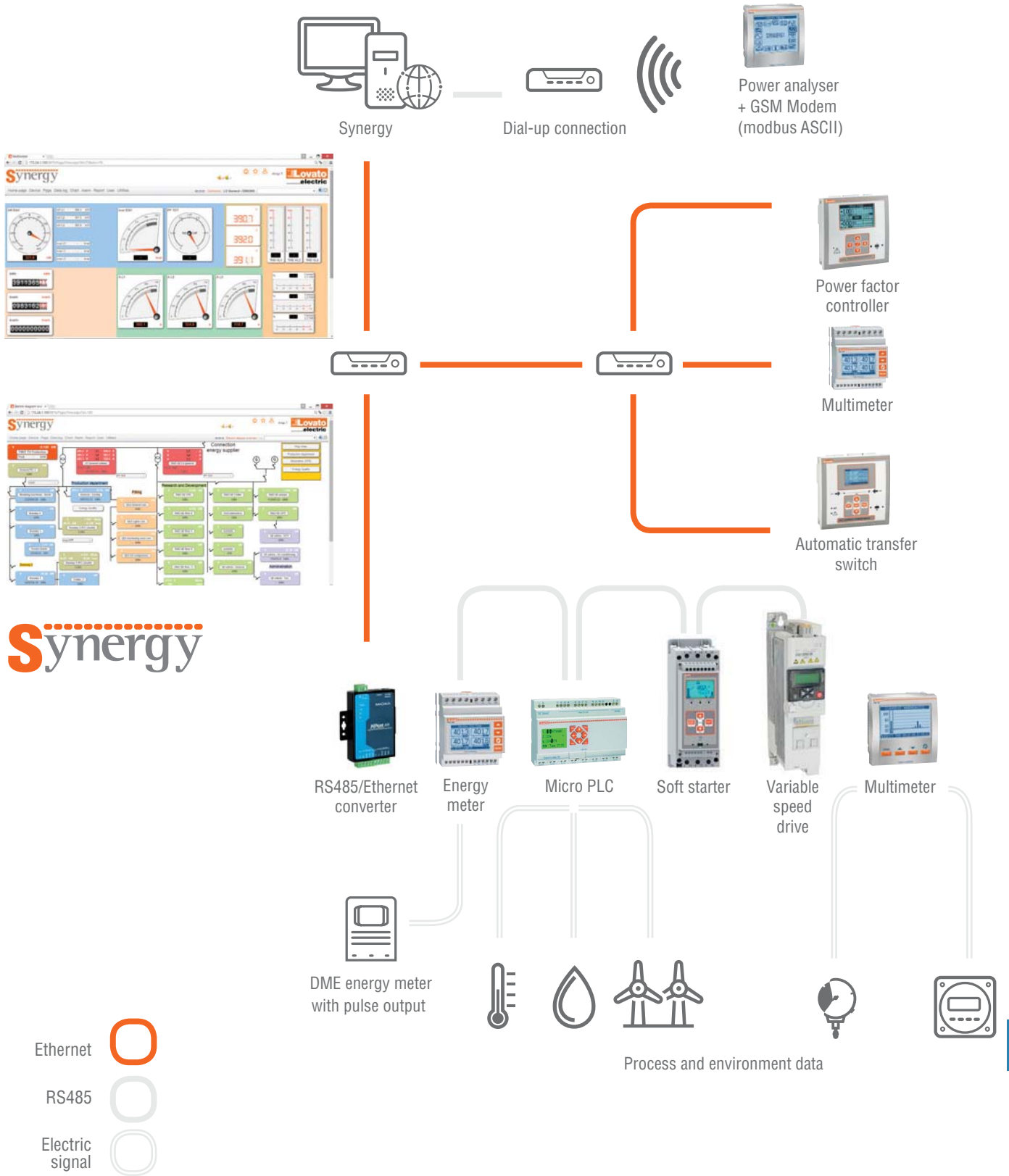

# DMG SERIES MULTIMETERS AND DME SERIES ENERGY METERS



Energy consumption monitoring

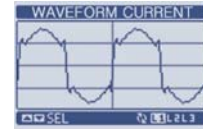
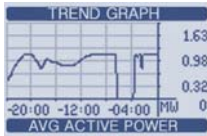

Energy quality verification



Energy quality analysis according to EN 50160



Water



Pressure



PT100 temperature



4-20mA  
0-10V



Alarms



Process data collection



Control and diagnostic







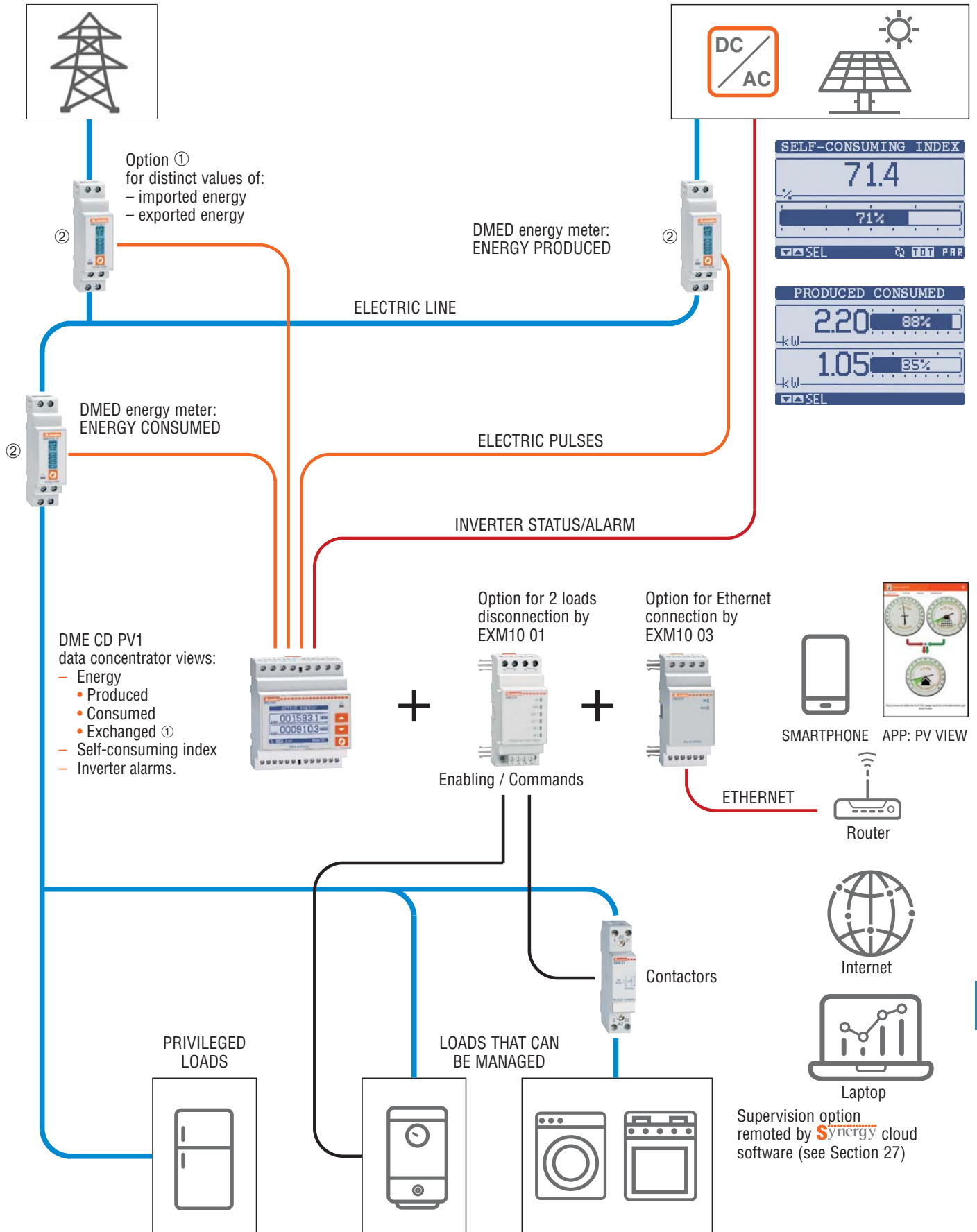



Boolean logic combination

# PHOTOVOLTAIC INSTALLATION MANAGEMENT



① If the distinct values of import and export energy need to be known, a third energy meter should be installed on the in-coming line; the exchanged energy is the difference between import and export energy with the power supplier.  
② The energy meters can be single or three phase based on the type of installation.



	ENERGY METERS - SINGLE PHASE			ENERGY METERS - MULTIMEASUREMENT - SINGLE PHASE					
Functions / Measurements	 DME M100	 DME M100 T1	 DME D100 T1	 DME D110 T1	 DME D115 T1	 DME D120 T1	 DME D121	 DME D130	
INSTALLATION									
Connection	Single phase								
Direct	32A	32A	40A	40A	40A	63A	63A	63A	
Through CT									
MV usage									
Built-in digital outputs		1 Pulse	1 Pulse	1 Programmable	1 Programmable	1 Programmable			
Built-in digital inputs									
Built-in communication port							RS485		
Expandible with modules EX... type									●
MID certified version			●	●		●			
Version with UTF certificates									
Current/Voltage accuracy	±0.5%								
Active energy accuracy (IEC/EN 62053-21/22 or EN 50470-3)	Class 1 (versions non MID) Class B (versions MID)								
Degree of protection	IP40								
MEASUREMENTS									
Active energy	Total	●	●	●	●	●	●	●	●
	Partial				●	●	●	●	●
Reactive energy	Total				●		●	●	●
	Partial				●		●	●	●
Separate energy count Import - Export									
Voltage									
Current									
Power									
Active power max demand				●	Active power max demand only	●	●	●	
Power factor									
Frequency									
Hour meter									
Cosφ									
THD (Total Harmonic Distortion)									
Detailed harmonic analysis									
Page	23-8/9			23-8/9	23-8	23-8/9	23-8		
EXPANSION MODULES									
Digital inputs/outputs									●
Analog inputs/outputs									
Communication ports									
Ethernet Gateway function									
GPRS-GSM modem									
Type of memory									





### Single phase, non expandable



DME M100



DME D110 T1...



DME D115 T1...  
DME D120 T1... - DME D121

Order code	Description	Qty per pkg	Wt
		n°	[kg]
Mechanical meter with mechanical display.			
DME M100	32A direct connection, 1U	1	0.084
DME M100 T1	32A direct connection, 1U 1 pulse output	1	0.088
Digital meter, with LCD screen.			
DME D100 T1	40A direct connection, 1U 1 pulse output, 220...240VAC	1	0.086
DME D100 T1 A120	40A direct connection, 1U 1 pulse output, 110...120VAC	1	0.086
DME D110 T1	40A direct connection, 1U 1 program. static output, multi-measurements ①, 220...240VAC	1	0.090
DME D110 T1 A120	40A direct connection, 1U 1 program. static output, multi-measurements ①, 110...120VAC	1	0.090
Digital meter with backlight LCD display.			
DME D115 T1	40A direct connection, 2U, 1 program. static output, multi-measurements ②, 220-240VAC	1	0.090
DME D120 T1	63A direct connection, 2U 1 program. static output, multi-measurements ①, 220-240VAC	1	0.148
DME D120 T1 A120	63A direct connection, 2U 1 program. static output, multi-measurements ①, 110...120VAC	1	0.148
DME D121	63A direct connection, 2U, RS485 interface multi-measurements ①, 220-240VAC	1	0.148

#### General characteristics

The energy meters are instruments for energy consumption measurement in single-phase installations with direct connection.

#### Operational characteristics

- DME M... (mechanical display)
- Rated supply voltage: 230VAC -20...+15%
  - Direct connection
  - 32A maximum current
  - Active energy measurements
  - Active energy accuracy: Class 1 (IEC/EN 62053-21)
  - Mechanical meter with 6+1 digit count
  - Flashing LED for consumption indication
  - Static pulse output for DME M100 T1 only
  - Modular DIN 43880 housing, 1 module
  - Sealable terminal blocks, standard supplied
  - IEC degree of protection: IP40 on front; IP20 at terminals.

DME D110T1–DME D110 T1–DME D115 T1–  
DME D120 T1–DME D121–DME D130

- Nominal supply voltage:
  - 220...240VAC for DME D...T1
  - 110...120VAC for DME D...T1 A120
- Voltage range:
  - 187...264VAC for DME D... T1
  - 93...132VAC for DME D...T1 A120
- Direct connection
- Maximum current: 40A for DME D100 T1, DME D110 T1..., DME D115 T1; 63A for DME D120 T1 – DME D121 – DME D130
- Active energy measurement and accuracy: Class 1 (IEC/EN 62053-21)
- Reactive energy measurement and accuracy: Class 2 (IEC/EN 62053-23) except for DME D115 T1
- LCD meter : With 5+1 digit count for DME D100/110 T1...; backlight with 6+1 digit count for DME D115 T1, DME D120 T1, DME D121, DME D130
- Metrological LED with pulse emission for consumption indication
- Clearable partial energy measurement except for DME D100/110 T1...
- One output: Pulse for DME D100 T1; programmable static for all other types
- Built-in RS485 port for DME D121; compatible with Synergy
- Modular housing, 1 module for DME D100 T1, DME D110 T1; 2 module for all other types
- Sealable terminal blocks, standard supplied
- protection degree: IP40 on front; IP20 at terminals.

**Synergy** supervision and energy management software  
See Section 27.

#### EXM series expansion modules

See Section 28, page 3.

#### Certifications and compliance

Certifications obtained: EAC; UL Listed, for USA and Canada (File E346886), as Electrical Process Control Equipment - Energy meters, for DME D... types. Compliant with standards: IEC/EN 61326-1 for DME M... type; EN 50470-3, IEC/EN 61010-1, UL 61010-1, CSA C22.2 n°61010-1 for DME D... types.

- ① Multi-measurements:
- Total and partial active energy
  - Total and partial reactive energy
  - Voltage
  - Current
  - Active and reactive power
  - Power factor
  - Frequency
  - Total and partial hour counter
  - Average active power (calculation on every last 15 minutes)
  - Maximum demand.

- ② Multi-measurements:
- Total and partial active energy
  - Active power
  - Average active power (calculation on every last 15 minutes)
  - Maximum demand.

### Single phase, expandable



DME D130



EXM10 01

Order code	Description	Qty per pkg	Wt
		n°	[kg]
Digital meter with backlight LCD display.			
DME D130	63A direct connection, 2U, multi-measurements ①, expandable, 220-240VAC	1	0.148
Order code			
Description			
DME D130 EXPANSION MODULES.			
Inputs and outputs.			
EXM10 01	2 opto-isolated digital inputs and 2 relay outputs 5A 250VAC		

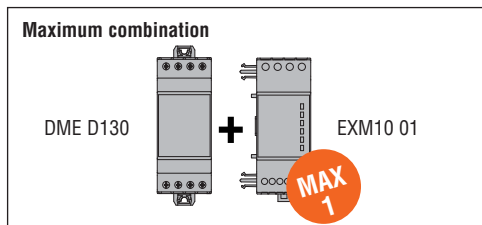

### Single phase, non expandable, MID certified

MID



DME D110 T1 MID



DME D120 T1 MID

Order code	Description	Qty per pkg	Wt
		n°	[kg]
Digital meter with LCD display.			
DME D100 T1 MID	40A direct connection, 1U 1 pulse output, 230VAC	1	0.086
DME D110 T1 MID	40A direct connection, 1U 1 programmable static output, multi-measurments ❶, 230VAC	1	0.090
DME D120 T1 MID	63A direct connection, 2U 1 programmable static output, multi-measurments ❶, 230VAC	1	0.148

#### General characteristics

The DME series energy meters, MID certified, are needed for billing purposes between electricity suppliers and consumers and for energy consumption measurement in directly connected single-phase installations. MID is the Measuring Instruments Directive of the European Union; instruments must be certified accordingly whenever used for monetary transactions in this territory.

#### Operational characteristics

- Nominal supply voltage: 230VAC
- Voltage range: 187-264VAC 50Hz
- Direct connection
- Maximum current: 40A for DME D100/110 T1 MID; 63A for DME D120 T1 MID
- Measurement of 14 electrical parameters for DME D110/120 T1 MID
- Active energy measurement and accuracy: Class B (EN 50470-3)
- Reactive energy measurement and accuracy: Class 2 (IEC/EN 62053-23)
- LCD meter:
  - With 5+1 digit count for DME D100/110 T1 MID
  - Backlight with 6+1 digit count for DME D120 T1 MID
- Metrological LED with pulse emission for consumption indication
- Clearable partial energy measurements (except for DME D100 T1 MID)
- One output: pulse for DME D100 T1 MID; programmable static for other types
- Modular housing, 1 module for DME D100/110 T1 MID; 2 module for DME D120 T1 MID
- Sealable terminal blocks, standard supplied
- EN protection degree: IP40 on front; IP20 at terminals.

#### Certifications and compliance

Certifications obtained: MID Class B, certifications per module B (type tests) and per module D (production conformity).

Compliant with standards: EN 50470-1, EN 50470-3.

#### ❶ Multi-measurements:

- Total and partial active energy
- Total and partial reactive energy
- Voltage
- Current
- Active and reactive power
- Power factor
- Frequency
- Total and partial hour counter
- Average active power (calculation on every last 15 minutes)
- Maximum demand.

### Three phase with or without neutral, non expandable



DME D300 T2



DME D330

Order code	Description	Qty per pkg	Wt
		n°	[kg]
Digital meter for three phase with neutral.			
DME D300 T2	63A direct connection, 4U, 2 programmable static outputs, multi-measurements ①	1	0.360
DME D301	80A direct connection, 4U, RS485 interface, multi-measurements ①	1	0.360
DME D305 T2	Connection by CT /5A, 4U, 2 programmable static outputs, multi-measurements ①	1	0.332
Digital meter for three phase with or without neutral.			
DME D330	Connection by CT /5A sec. 4U, RS485 interface, multi-measurements ①	1	0.332

**new**

**new**

### Three phase with or without neutral, expandable



DME D310 T2

Order code	Description	Qty per pkg	Wt
		n°	[kg]
Digital meter for three phase with or without neutral.			
DME D310 T2	Connection by CT /5A secondary, 2 programmable static outputs, 4U, LCD graphic display multi-measurements ①, expandable	1	0.332

Order code	Description
DME D310 T2 EXPANSION MODULES. Inputs and outputs.	
EXM10 00	2 digital inputs and 2 static outputs, opto-isolated
EXM10 01	2 opto-isolated digital inputs and 2 relay outputs rated 5A 250VAC
Communication ports.	
EXM10 10	Opto-isolated USB interface
EXM10 11	Opto-isolated RS232 interface
EXM10 12	Opto-isolated RS485 interface
EXM10 13	Ethernet interface with Web server function
EXM10 20	Opto-isolated RS485 interface and 2 relay outputs rated 5A 250VAC
EXM10 30	Data storage, clock-calendar (RTC) with backup reserve energy for data logging



EXM10 10

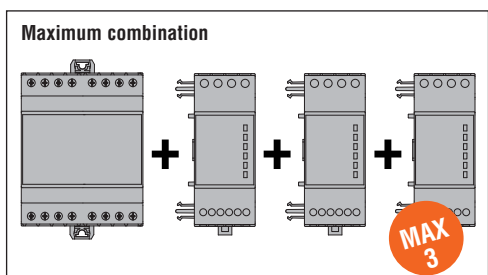

#### General characteristics

The energy meters are digital meters/analyzers of electric energy for systems with direct three-phase connection or by CT. Expandable with up to 3 EXM series interfaced by infrared beam.

#### Operational characteristics

- Nominal supply voltage:
  - 380...415VAC (L-L) for DME D300 T2, DME D310 T2, DME D330 and DME D305
  - 190...415VAC (L-L) for DME D301
- Voltage range:
  - 323...456VAC (L-L) for DME D300 T2, DME D310 T2, DME D330 T2 and DME D305
  - 162...456VAC (L-L) for DME D301
- Direct connection 63A for DME D300 T2 and 80A for DME D301
- Connection by TA /5A or 1A for DME D310 T2, DME D330 and DME D305 T2
- Active energy measurement and accuracy: Class 0,5s (IEC/EN 62053-22) for DME D301, DME D305 T2 and DME D330 Class 1 (IEC/EN 62053-21) for other types.
- Active energy measurement and accuracy: Class 2 (IEC/EN 62053-23)
- LCD multifunction meter
- Metrological LED with pulse emission for consumption indication
- Clearable partial active energy measurements
- 1 programmable digital input
- 2 programmable static outputs except DME D330 and DME D301
- Built-in RS485 port for DME D330 and DME D301 and optional for DME D310 T2; compatible with Synergy and Xpress
- Optic interface for EXM10... expansion modules with DME D310 T2
- Modular housing, 4 module
- Sealable terminal blocks, standard supplied
- Degree of protection: IP40 on front; IP20 at terminals.

**Synergy** supervision and energy management software  
See Section 27.

**Xpress** configuration and remote control software  
See Section 27.

**EXM series expansion modules**  
See page 28-3.

#### Certifications and compliance

Certifications obtained: EAC.  
Compliant with standards: EN 50740-3, IEC/EN 61010-1.

#### ① Multi-measurements:

- Total and partial active energy
- Total and partial reactive energy
- Voltage
- Current
- Active and reactive power
- Power factor
- Frequency
- Total and partial hour counter
- Average active power (calculation on every last 15 minutes)
- Maximum demand.

### Three phase with neutral, non expandable, MID certified

MID



DME D300 T2 MID

Order code	Description	Qty per pkg	Wt
		n°	[kg]
Digital meter for three phase with neutral.			
DME D300 T2 MID	63A direct connection, 2 programmable static outputs, multi-measurements	1	0.360

### Three phase with or without neutral, expandable, MID certified

MID



DME D310 T2 MID

Order code	Description	Qty per pkg	Wt
		n°	[kg]
Digital meter for three phase with or without neutral.			
DME D310 T2 MID	Connection by CT /5A secondary, 2 programmable static outputs, LCD graphic display multi-measurements, expandable	1	0.332

Order code	Description
DME D310 T2 MID EXPANSION MODULES. Inputs and outputs.	
EXM10 00	2 digital inputs and 2 static outputs, opto-isolated
EXM10 01	2 opto-isolated digital inputs and 2 relay outputs rated 5A 250VAC
Communication ports.	
EXM10 10	Opto-isolated USB interface
EXM10 11	Opto-isolated RS232 interface
EXM10 12	Opto-isolated RS485 interface
EXM10 13	Ethernet interface with Web server function
EXM10 20	Opto-isolated RS485 interface and 2 relay outputs rated 5A 250VAC
EXM10 30	Data storage, clock-calendar (RTC) with backup reserve energy for data logging



EXM10 10

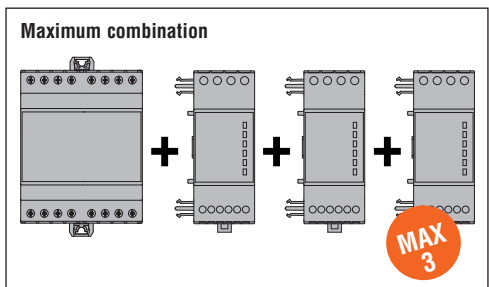

#### General characteristics

The DME series energy meters, MID certified, are needed for billing purposes between electricity suppliers and consumers and for energy consumption measurement in directly or CT connected three-phase installations. Expandable with up to 3 EXM series interfaced by infrared beam.

#### Operational characteristics

- Nominal supply voltage: 230VAC (L-N); 400VAC (L-L)
- Voltage range: 187-264VAC (L-N); 323-456VAC (L-L)
- Direct connection 63A for DME D300 T2
- Connection by CT /5A for DME D310 T2 MID
- Active energy measurement and accuracy: Class B (EN 50470-3)
- Reactive energy measurement and accuracy: Class 2 (IEC/EN 62053-23)
- LCD multifunction meter
- Metrological LED with pulse emission for consumption indication
- Clearable partial energy measurements
- 1 programmable digital input
- 2 programmable static outputs
- Optic interface for EXM10... expansion modules with DME D310 T2 MID compatible with **Synergy** and **Xpress**
- Modular housing 4 module
- Sealable terminal blocks, standard supplied
- Degree of protection: IP40 on front; IP20 at terminals.

**Synergy** supervision and energy management software  
See Section 27.

**Xpress** configuration and remote control software  
See Section 27.

**EXM series expansion modules**  
See page 28-3.

#### Certifications and compliance

Certifications obtained: MID Class B (EN 50470-1, EN 50470-3), certifications per module B (type tests) and per module D (production conformity).  
Compliant with standards: EN 50470-1, EN 50470-3.

#### Multi-measurements:

- Total and partial active energy
- Total and partial reactive energy
- Voltage
- Current
- Active and reactive power
- Power factor
- Frequency
- Total and partial hour counter
- Average active power (calculation on every last 15 minutes)
- Maximum demand.



### Three phase with neutral, non expandable, MID certified



DME D300 F

Order code	Description	Qty per pkg	Wt
		n°	[kg]
Digital meter for three phase with neutral, complete with UTF certificates for installations in Italy.			
DME D300 F	MID certified type, 63A direct connection, 4U, 2 programmable static outputs, non expandable, multi-measurements, complete with UTF certificate	1	0.360

### Three phase with or without neutral, expandable, MID certified



DME D310 F...



Order code	Description of CTs included	Qty per pkg	Wt
		n°	[kg]
Kit comprising 1 DMED310T2MID type MID 4U digital counter and three /5A and class 0.5s current transformers.			
DME D310 F060	60/5A type DM1TP0060	1	2.100
DME D310 F080	80/5A type DM1TP0080	1	2.200
DME D310 F100	100/5A type DM1TP0100	1	1.900
DME D310 F150	150/5A type DM1TP0150	1	1.900
DME D310 F200	200/5A type DM1TP0200	1	1.900
DME D310 F250	250/5A type DM1TP0250	1	1.900
DME D310 F300	300/5A type DM1TP0300	1	1.900
DME D310 F400	400/5A type DM1TP0400	1	1.900
DME D310 F500	500/5A type DM3TP0500	1	2.200
DME D310 F600	600/5A type DM3TP0600	1	2.200
DME D310 F800	800/5A type DM3TP0800	1	2.200
DME D310 F1000	1000/5A type DM5TP1000	1	2.400
DME D310 F1250	1250/5A type DM5TP1250	1	2.400
DME D310 F1600	1600/5A type DM5TP1600	1	2.400
DME D310 F2000	2000/5A type DM5TP2000	1	2.400
DME D310 F2500	2500/5A type DM5TP2500	1	2.400
DME D310 F3000	3000/5A type DM5TP3000	1	2.400

Order code	Description
DME D310 F EXPANSION MODULES. Inputs and outputs.	
EXM10 00	2 digital inputs and 2 static outputs, opto-isolated
EXM10 01	2 opto-isolated digital inputs and 2 relay outputs rated 5A 250VAC
Communication ports.	
EXM10 10	Opto-isolated USB interface
EXM10 11	Opto-isolated RS232 interface
EXM10 12	Opto-isolated RS485 interface
EXM10 13	Opto-isolated Ethernet interface
EXM10 20	Opto-isolated RS485 and 2 relay outputs rated 5A 250VAC



EXM10 10

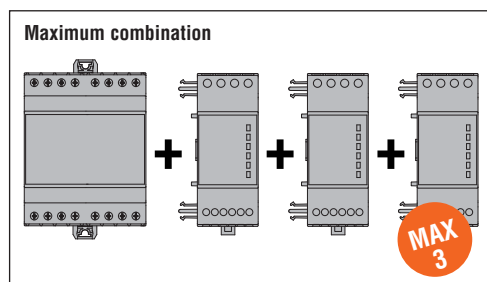

### General characteristics

The DME series energy meters, MID certified, are needed for billing purposes between electricity suppliers and consumers and for energy consumption measurement in directly or CT connected three-phase installations. Expandable with up to 3 EXM series expansion modules interfaced by infrared beam DME D310 F...

**The UTF certificate is required in the case of taxation in Italy (electricity-generating installations).**

### Operational characteristics

DME D300 F - DME D310 F... of starter kit

- Nominal supply voltage: 230VAC (L-N); 400VAC (L-L)
- Voltage range: 187...264VAC (L-N); 323...456VAC (L-L)
- Direct connection 63A for DME D300 F
- Connection by CT /5A, standard supplied, for DME D310 F...
- Active energy measurement and accuracy: Class B (EN 50470-3)
- Reactive energy measurement and accuracy: Class 2 (IEC/EN 62053-23)
- LCD multifunction meter
- Metrological LED with pulse emission for consumption indication
- Clearable partial energy measurements
- 1 programmable digital input
- 2 programmable static outputs
- Optic interface for EXM 10... series expansion modules with DME D310 F... compatible with Synergy and Xpress
- Modular housing 4 module
- Sealable terminal blocks, standard supplied
- Degree of protection: IP40 on front; IP20 at terminals.

### Multi-measurements

- Total and partial active energy
- Total and partial reactive energy
- Voltage
- Current
- Active and reactive power
- Power Factor
- Frequency
- Total and partial hour counter
- Average active power (calculation on every last 15 minutes)
- Maximum demand.

### DM5T CURRENT TRANSFORMERS...

- Operating frequency: 50...60Hz
- Secondary output current: 5A
- Overload withstand: 120% I<sub>pn</sub>
- Rated insulation voltage U<sub>i</sub>: 720V
- Rated short time thermal current I<sub>th</sub>: 40-60I<sub>pn</sub> for 1 second
- Rated dynamic current I<sub>dyn</sub>: 2.5I<sub>th</sub> for 1 second
- Insulation (dry type): class E
- Screw fixing terminals
- Standard supplied sealable terminal covers and fixing elements
- EN degree of protection: IP30.

**Synergy supervision and energy management software**  
See Section 27.

**Xpress configuration and remote control software**  
See Section 27.

**EXM series expansion modules**  
See page 28-3.

### Certifications and compliance

Certifications obtained: MID Class B (EN 50470-1, EN 50470-3), certifications per module B (type tests) and per module D (production conformity) for DME D300 F and DME D310F energy meters. UTF certificates for the DME D300F and for each component of the starter kits are standard supplied. Compliant with standards: EN 50470-1, EN 50470-3 for DME D300 F and DME D310 T2 MID; IEC/EN 60044-1 for DM5T...

### Expandable



DME CD - DME CD PV1

Order code	Description	Qty per pkg	Wt
		n°	[kg]
Data concentrator for general use.			
DME CD	With 8 programmable digital inputs, expandable, for data collection + pulse count from DMEM100T1 and DME D..., RS485 port	1	0.337
Data concentrator for photovoltaic applications.			
DME CD PV1	Programmed for installation control and data collection+pulse count from two DMED minimum, RS485 port, expandable	1	0.340

❶ Except DME D100 T1.



EXM10 10

Order code	Description
DME CD AND DME CD PV1 EXPANSION MODULES. Inputs and outputs.	
EXM10 00	2 digital inputs and 2 static outputs, opto-isolated
EXM10 01	2 opto-isolated digital inputs and 2 relay outputs rated 5A 250VAC
EXM10 02	4 opto-isolated digital inputs and 2 relay outputs rated 5A 250VAC
Communication ports.	
EXM10 10	Opto-isolated USB interface
EXM10 11	Opto-isolated RS232 interface
EXM10 12	Opto-isolated RS485 interface
EXM10 13	Ethernet interface with Web server function
EXM10 20	Opto-isolated RS485 interface and 2 relay outputs, rated 5A 250VAC
EXM10 30	Data storage, clock-calendar (RTC) with backup reserve energy for data logging

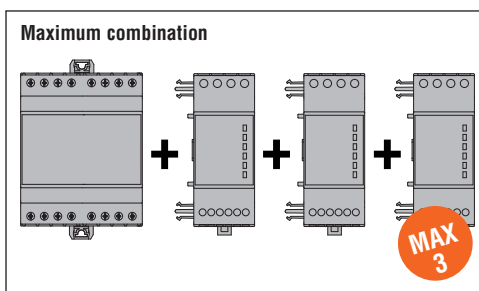

### General characteristics

DME CD is equipped with 8 inputs, which can be increased up to a maximum of 14 and allows to indirectly interface devices without communication as long as they have at least one pulse output.

It is capable of pulse counting that come in from the outputs of meters for energy, water, gas and other types of consumption: All data is viewed on its display or can also be available for PCs through its built-in RS485 interface using Synergy or Xpress software.

It can be expanded with up to 3 EXM series modules by optical interface.

With the programmable functions, average values can be determined for instantaneous quantities, such as power, speed, production rate, gas and water consumption, etc.

DME CD PV1 is specific for the monitoring of solar installations and needs to be connected to at least two DME D... meters (single or three phase). The user can available of data, such as energy produced by the generating installation, energy consumed by loads as well as exchanged energy (difference between import and export energy) with the power supplier.

It is already programmed to automatically calculate the self-consuming index and autonomy, mean power values, production (total and partial values) and the operating status of the AC/DC inverter, if it is equipped with digital outputs.

In addition, it can be customised by the user for load supervision, using the EXM series expansion modules, according to the defined logics and on the basis of the energy available.

### Operational characteristics

- Nominal supply voltage: 100...240VAC/110...250VDC
- Voltage range: 85...264VAC/93,5...300VDC
- Backlight graphic LCD
- 8 inputs, expandable with EXM 10... modules up to 14
- Built-in RS485 communication port
- Modbus-RTU, ASCII and TCP communication protocol
- Multifunction display
- Clearable total and partial counters for each channel
- Programmable general counters
- Calculation of derivative average values
- Mathematical operations among counters
- Modular housing, 4 module
- IEC degree of protection: IP40 on front; IP20 at terminals.

Synergy supervision and energy management software  
See Section 27.

Xpress configuration and remote control software  
See Section 27.

EXM series expansion modules  
See page 28-3.

### Certifications and compliance

Certifications obtained: EAC for all; UL listed for USA and Canada (cULus – File E346886), as Electrical Process Control Equipment – Data concentrator for DMECD; pending for DMECDPV1 and DMEKITCDPV1100.

### Modular LCD multimeters non expandable



DMG 1...



DMG 200 - DMG 210

new

Order code	Description	Qty per pkg.	Wt
		n°	[kg]
DMG 100	Icon LCD, auxiliary supply 100...240VAC/120...250VDC. Multilanguage: Italian, English, French, Spanish, Portuguese and German	1	0.294
DMG 101	Icon LCD, auxiliary supply 100...240VAC/120...250VDC. 2 digital inputs and 2 outputs. Multilanguage: Italian, English, French, Spanish, Portuguese and German	1	0.294
DMG 110	Icon LCD, RS485 port, auxiliary supply 100...240VAC/120...250VDC. Multilanguage: Italian, English, French, Spanish, Portuguese and German	1	0.294
DMG 200	Graphic 128x80 pixel LCD, auxiliary supply 100-240VAC/110-250VDC. Multilanguage: Italian, English, French, Spanish and Portuguese	1	0.294
DMG 200 L01	Graphic 128x80 pixel LCD, auxiliary supply 100-240VAC/110-250VDC. Multilanguage: English, Czech, Polish, German and Russian	1	0.294
DMG 210	Graphic 128x80 pixel LCD, RS485 port, auxiliary supply 100-240VAC/110-250VDC. Multilanguage: Italian, English, French, Spanish and Portuguese	1	0.300
DMG 210 L01	Graphic 128x80 pixel LCD, RS485 port, auxiliary supply 100-240VAC/110-250VDC. Multilanguage: English, Czech, Polish, German and Russian	1	0.300

#### General characteristics

DMG... digital multimeters are available with a modular housing, 4 module size, and are equipped with a graphic backlight LCD (except DMG 100/101/110 with icon display) capable of providing extremely clear, intuitive and flexible viewing of all electrical parameters of an installation. For DMG 110 and DMG 210 versions, there is a built-in isolated RS485 interface, while DMG 101 features 2 programmable digital inputs and 2 outputs.

#### Main measurements:

- Voltage: phase, line and system values
- Current: phase values (neutral current calculated)
- Power: apparent, active and reactive phase and total values
- P.F.: Power Factor per phase and total
- Frequency of measured voltage value
- HIGH-LOW-AVERAGE value functions of all measurements
- Maximum demand of power and current values
- Asymmetric voltage and current
- Total harmonic distortion (THD) of voltage and current values
- Energy meters for active, reactive and apparent values
- Hour counter (total and partial, 1 on DMG 200/210, 4 programmable on DMG 100/101/110)
- Phase energy (DMG 100/110)
- Harmonic analysis up to the 15th order (DMG 100/110).

#### Operational characteristic

- Auxiliary supply voltage range: 85...264VAC / 93,5...300VDC
- Maximum rated measurement voltage
  - 600VAC (DMG 100/101/110)
  - 690VAC (DMG 200/210)
- Voltage measurement range:
  - 50...720VAC phase-to-phase (DMG 100/101/110)
  - 20...830VAC phase-to-phase (DMG 200/210)
- Usage in medium and high-voltage systems with voltage transformers
- Rated input current: With external CT /5A (also 1A for DMG 100/101/110)
- Current measurement range with CT up to 10,000A
- Frequency measurement range: 45-66Hz
- True RMS measurements for voltage and current values
- Accuracy:
  - Voltage:  $\pm 0,5\%$  (50...720VAC for DMG 1...)
  - (50...830VAC) for DMG 2...
  - Current:  $\pm 0,5\%$  (0,1...1,1In)
  - Power:  $\pm 1\%$  f.s.
  - Frequency:  $\pm 0,05\%$
  - Active energy: Class 1 (IEC/EN 62053-21)
  - Reactive energy: Class 2 (IEC/EN 62053-23)
- Non-volatile memory for data storage
- Communication protocol Modbus-RTU and ASCII (only for DMG 210 and DMG 110)
- Programming and remote control by software (only for DMG 210 and DMG 110; compatible with Synergy and Xpress software)
- Modular housing, 4 module
- Degree of protection: IP40 on front; IP20 at terminals.

#### CURRENT TRANSFORMERS OF DMG... KITS

- Operating frequency: 50...60Hz
- Secondary output current: 5A
- Overload withstand: 120% I<sub>pn</sub>
- Rated insulation voltage U<sub>i</sub>: 720V
- Rated short time thermal current I<sub>th</sub>: 40...60I<sub>pn</sub> for 1 second
- Rated dynamic current I<sub>dyn</sub>: 2,5I<sub>th</sub> for 1 second
- Insulation (dry type): class E
- Faston terminals
- Degree of protection: IP30.

**Synergy** supervision and energy management software  
See Section 27.

**Xpress** configuration and remote control software  
See Section 27.

#### Certifications and compliance

Certifications obtained: EAC for all; UL Listed for USA and Canada (cULus - File E93601), as Auxiliary Devices - Multimeter for DMG 1.../DMG 2... types.  
Compliant with standards: IEC/EN 61010-1, IEC/EN 61000-6-2, IEC/EN 61000-6-4; UL61010-1, CSA C22.2 n° 61010-1 for DMG 100/110 (DMG 101 pending); UL508, CSA C22.2 n° 14 for DMG 200/210; IEC/EN 60044-1 for transformers of starter kits.

### Starter kits



DMG KIT 100 150

new

Order code	Description	Qty per pkg	Wt
		n°	[kg]
DMG KIT 100 060	Composed of one DMG 100 multimeter and n°3 CTs 60/5A for Ø22mm cable	1	1.035
DMG KIT 100 100	Composed of one DMG 100 multimeter and n°3 CTs 100/5A for Ø22mm cable	1	1.035
DMG KIT 100 150	Composed of one DMG 100 multimeter and n°3 CTs 150/5A for Ø23mm cable	1	0.856
DMG KIT 100 250	Composed of one DMG 100 multimeter and n°3 CTs 200/5A for Ø23mm cable	1	0.856



### Modular LCD multimeters expandable



DMG 300



EXM10 10

Order code	Description	Qty per pkg	Wt
		n°	[kg]
DMG 300	Graphic 128x80 pixel LCD, harmonic analysis, auxiliary supply 100-240VAC/110-250VDC, expandable with modules series EXM... Multilanguage: Italian, English, French, Spanish and Portuguese	1	0.320
DMG 300 L01	Graphic 128x80 pixel LCD, harmonic analysis, auxiliary supply 100-240VAC/110-250VDC, expandable with modules series EXM... Multilanguage: English, Czech, Polish, German and Russian	1	0.320

Order code	Description
DMG 300 AND DMG 300 L01 EXPANSION MODULES. Inputs and outputs.	
EXM10 00	2 digital inputs and 2 static outputs, opto-isolated
EXM10 01	2 opto-isolated digital inputs and 2 relay outputs rated 5A 250VAC
EXM10 02	4 opto-isolated digital inputs and 2 relay outputs rated 5A 250VAC
Communication ports.	
EXM10 10	Opto-isolated USB interface
EXM10 11	Opto-isolated RS232 interface
EXM10 12	Opto-isolated RS485 interface
EXM10 13	Ethernet interface with Web server function
EXM10 20	Opto-isolated RS485 interface and 2 relay outputs rated 5A 250VAC
EXM10 30	Data storage, clock-calendar (RTC) with backup battery for data logging

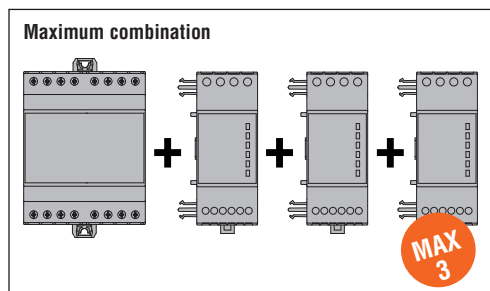

#### General characteristics

DMG 300 digital multimeters are available with a modular housing, 4 module size, and are equipped with a graphic backlight LCD capable of providing extremely clear, intuitive and flexible viewing of all electrical parameters of a system. The very accurate measurements combined with their extreme compactness provide an ideal solution for every type of application.

Expandable with up to 3 EXM series modules interfaced by infrared beam.

#### Main measurements:

- Voltage: phase, line and system values
- Current: phase values (neutral current calculated)
- Power: apparent, active and reactive phase and total values
- P.F.: Power Factor per phase and total
- Frequency of measured voltage value
- HIGH-LOW-AVERAGE value functions for all measurements
- Maximum demand of power and current values
- Voltage and current asymmetry
- Total harmonic distortion (THD) of voltage and current values
- Harmonic analysis of voltage and current up to 31<sup>st</sup> order
- Energy meters for active, reactive, apparent partial and total values, programmable tariff functions
- Hour counter for programmable total and partial hours
- Pulse counter for general use: consumption pulse counting for water, gas, etc. with expansion module only.

#### Operational characteristics

- Auxiliary supply voltage range: 85...264VAC / 93.5...300VDC
- Voltage measurement range: 20...830VAC phase-to-phase  
10...480VAC phase-neutral
- Usage in medium and high-voltage systems with voltage transformers
- Rated input current: With external CT, 5A or 1A
- Current measurement range with CT up to 10,000A
- Frequency measurement range: 45-66Hz
- True RMS measurements for voltage and current values
- Accuracy:
  - Voltage:  $\pm 0.2\%$  (50-830VAC)
  - Current:  $\pm 0.2\%$  (0.1-1.1 In)
  - Power:  $\pm 0.5\%$  f.s.
  - Power factor:  $\pm 0.5\%$
  - Frequency: 0.05%
  - Active energy: Class 0.5S (IEC/EN 62053-22)
  - Reactive energy: Class 2 (IEC/EN 62053-23)
- Non-volatile memory for data storage
- Communication protocol Modbus-RTU, ASCII and TCP (only with communication expansion modules)
- Programming and remote control by software (only with communication expansion modules); compatible with **Synergy** and **Xpress** software
- Modular housing, 4 module
- Degree of protection: IP40 on front; IP20 at terminals.

**Synergy** supervision and energy management software  
See Section 27.

**Xpress** configuration and remote control software  
See Section 27.

**EXM10 series expansion modules**  
See page 28-3.

**Certifications and compliance**  
Certifications obtained: EAC; UL Listed, for USA and Canada (cULus - File E93601), as Auxiliary Devices - Multimeters.  
Compliant with standards: IEC/EN 61010-1, IEC/EN 61000-6-2, IEC/EN 61000-6-4, UL508, CSA C22.2 n° 14.

### Flush mount LCD multimeters, expandable



DMG 600 - DMG 610



DMG 700 - DMG 800...



DMG M3 800 01

Order code	Description	Qty per pkg	Wt [kg]
DMG 600	Backlight icon LCD 72x46mm harmonic analysis, auxiliary supply 100...440VAC/120...250VDC, front optical port. Multilanguage: Italian, English, French, Spanish, Portuguese and German.	1	0.300
DMG 610	Backlight icon 72x46mm harmonic analysis, auxiliary supply 100...440VAC/120...250VDC, built-in RS485 front optical serial port. Multilanguage: Italian, English, French, Spanish, Portuguese and German	1	0.350
DMG 700	Graphic 128x80 pixel LCD, auxiliary supply 100...440VAC/110...250VDC Multilanguage: Italian, English, French, Spanish and Portuguese	1	0.510
DMG 700 L01	Graphic 128x80 pixel LCD, auxiliary supply 100...440VAC/110...250VDC Multilanguage: English, Czech, Polish, German and Russian	1	0.510
DMG 800	Graphic 128x80 pixel LCD, harmonic analysis, auxiliary supply 100...440VAC/110...250VDC Multilanguage: Italian, English, French, Spanish and Portuguese	1	0.510
DMG 800 L01	Graphic 128x80 pixel LCD, harmonic analysis, auxiliary supply 100...440VAC/110...250VDC Multilanguage: English, Czech, Polish, German and Russian	1	0.510
DMG 800 D048	Graphic 128x80 pixel LCD, harmonic analysis, auxiliary supply 12-24-48VDC	1	0.520
DMG M3 800 01	DMG 800 portable unit in M3N case, prewired, for mobile applications, with USB port, without external cable (see p. 23-26)	1	3.300

Order code	Description
DMG600/610, DMG700, DMG800 EXPANSION MODULES	
Inputs and outputs.	
EXP10 00	4 opto-isolated digital inputs
EXP10 01	4 opto-isolated static outputs
EXP10 02	2 digital inputs and 2 static outputs, opto-isolated
EXP10 03	2 relay outputs rated 5A 250VAC
EXP10 04	2 opto-isolated analog inputs 0/4-20mA or PT100 or 0-10V or 0...±5V for DMG 800
EXP10 05	2 opto-isolated analog outputs 0/4-20mA or 0-10V or 0...±5V for DMG 800
EXP10 08	2 opto-isolated digital inputs and 2 relay outputs rated 5A 250VAC
Communication ports.	
EXP10 10	Opto-isolated USB interface
EXP10 11	Opto-isolated RS232 interface
EXP10 12	Opto-isolated RS485 interface
EXP10 13	Opto-isolated Ethernet interface with web server function
EXP10 14	Opto-isolated Profibus-DP interface for DMG 800
EXP10 30	Data storage, clock-calendar (RTC) with backup reserve energy for data logging for DMG 800



EXP10...

### General characteristics

DMG 600/610, DMG 700 and DMG 800 digital multimeters are capable of viewing the measurements with high accuracy on the wide graphic LCD, which allow to control energy distribution networks. They are available with a flush-mount housing, (96x96mm/3.78"x3.78") and expansion slots to fit plug-in expansion modules (1 for DMG 600/610 and 4 for DMG 700/800), suitable for numerous applications. The main features include an extended power supply voltage range, high measurement accuracy, expandability and graphic interactive interface for simple use. Main measurements:

- Voltage: phase, line and system values
- Current: phase values (neutral current calculated)
- Power: apparent, active and reactive phase and total values
- P.F.: Power Factor per phase and total
- Frequency of measured voltage value
- HIGH-LOW-AVERAGE value functions for all measurements
- Maximum demand of power and current values
- Voltage and current asymmetry
- Total harmonic distortion (THD): voltage and current
- Harmonic analysis of voltage and current up to the 15<sup>th</sup> (DMG 600/610) and 31<sup>st</sup> order (only DMG 800)
- Energy meters for active, reactive, apparent partial and total values
- Programmable tariff functions (only DMG 700/800)
- Hour counter for programmable total and partial hours
- Pulse counter for general use: consumption pulse counting for water, gas, etc., with expansion module only DMG 700/800.

### Operational characteristics

- Auxiliary supply voltage range:
  - 90...484VAC / 93,5...300VDC per DMG 600/610/700/800
  - 9...70VDC per DMG 800 D048
- Voltage measurement range:
  - 20...830VAC L-L / per DMG 700/800
  - 50...720VAC L-L per DMG 600/610
- Usage in medium and high voltage systems with voltage transformers
- Rated input current: By external CT 5A for DMG 700; By external CT 5A or 1A for DMG 600/610, DMG 800
- Frequency measurement range 45...66Hz
- True RMS measurements: for voltage and current
- Measurement accuracy for DMG 600/610-DMG 700:
  - Voltage: ±0,5% (50...720VAC per DMG 600/610; 50...830VAC per DMG 700)
  - Current: ±0,5% (0,1...1,1In)
  - Power: ±1% f.s.
  - Frequency: ±0,05%
  - Active energy: Classe 1 (IEC/EN 62053-21)
  - Reactive energy: Class 2 (IEC/EN 62053-23)
- Measurement accuracy for DMG 800...:
  - Voltage: ±0,2% (50...830VAC)
  - Current: ±0,2% (0,1...1,1In)
  - Power: ±0,5% f.s.
  - Power factor: ±0,5%
  - Frequency: ±0,05%
  - Active energy: Class 0,5s (IEC/EN 62053-22)
  - Reactive energy: Class 2 (IEC/EN 62053-23)
- Non-volatile memory for data storage
- Communication protocol Modbus-RTU, ASCII and TCP
- Compatible with **Synergy** and **Xpress** software
- Flush-mount housing 96x96mm/3.78"x3.78"
- Degree of protection: On front IP54 DMG 600/610; IP65 all others. All IP20 at terminals.

Overall M3N case dimensions: See page 4-17.

**Synergy** supervision and energy management software See Section 27.

**Xpress** configuration and remote control software See Section 27.

EXP series expansion modules See page 28-2.

### Certifications and compliance

Certifications obtained: EAC for all except DMGM380001; UL listed for USA and Canada (cULus – File E93601), as Auxiliary Devices – Multimeters for DMG... types pending for DMG600/610 and excluding DMGM380001. Compliant with standards: IEC/EN 61010-1, IEC/EN 61000-6-2, IEC/EN 61000-6-3, UL508, CSA C22-2 n°14.

### Flush mount LCD touch-screen power analyzers, expandable



DMG 900...



DMG M3 900 01



DMG 900T...



DMG 900RD



EXP10...

Order code	Description	Qty per pkg.	Wt
		n°	[kg]
DMG 900	Graphic 128x112 pixel touch-screen LCD, harmonic analysis, 4 current channels, (neutral meas.), 100...440VAC/110...250VDC. Multilanguage: Italian, English, French, Spanish and Portuguese	1	0.566
DMG 900 L01	Graphic 128x112 pixel touch-screen LCD, harmonic analysis, 4 current channels, (neutral meas.), 100...440VAC/110...250VDC. Multilanguage: English, Czech, Polish, German and Russian	1	0.566
DMG 900 D048	Graphic 128x112 pixel touch-screen LCD, harmonic analysis, 4 current channels, auxiliary supply 12-24-48VDC	1	0.580
DMG M3 900 01	DMG 900 portable unit in M3N case, prewired for mobile applications, with USB port, without external cables (see page 23-26)	1	3.400
DMG 900T	Measurement transducer, harmonic analysis, 4 current channels (neutral meas.), 100...440VAC/110...250VDC, RS232 and RS485 ports ①	1	0.570
DMG 900T D048	Measurement transducer, harmonic analysis, 4 current channels (neutral meas.), 12-24-48VDC, RS232 and RS485 ports ①	1	0.590
Remote display for DMG 900T...			
DMG 900RD	Graphic 128x112 pixel touch screen LCD, with 3m long connecting cable②	1	0.396

- ① No simultaneous operations of serial ports. Consult Customer Service for information (Tel. 035 4282422; E-mail: service@LovatoElectric.com) or the instructions manual.  
 ② Direct link to DMG 900T dedicated port: powered directly by DMG 900T.

Order code	Description
DMG 900 and DMG 900 T EXPANSION MODULES. Inputs and outputs.	
EXP10 00	4 opto-isolated digital inputs
EXP10 01	4 opto-isolated static outputs
EXP10 02	2 digital inputs and 2 static outputs, opto-isolated
EXP10 03	2 relay outputs rated 5A 250VAC
EXP10 04	2 opto-isolated analog inputs 0/4-20mA or PT100 or 0-10V or 0...±5V
EXP10 05	2 opto-isolated analog outputs 0/4-20mA or 0-10V or 0...±5V
EXP10 08	2 opto-isolated digital inputs and 2 relay outputs rated 5A 250VAC
Communication ports.	
EXP10 10	Opto-isolated USB interface
EXP10 11	Opto-isolated RS232 interface
EXP10 12	Opto-isolated RS485 interface
EXP10 13	Opto-isolated Ethernet interface with Web server function
EXP10 14	Opto-isolated Profibus-DP interface
EXP10 15	GPRS/GSM modem, without antenna
EXP10 30	Data storage, clock-calendar (RTC) with backup reserve energy for data logging
EXP10 31	Data storage, with Energy Quality (EN 50160 - class B), clock-calendar (RTC) with backup reserve energy for data logging

### General characteristics

DMG 900... expandable digital power analyzers are available with a flush-mount housing, 96x96mm/3.78"x3.78". The wide graphic touch screen display provides extremely simple interacting between the device and the user. The high performance of the power analyzers gives very accurate measurements and can control energy distribution networks, to detect and prevent energy problems which could compromise quality and supply. The main features include an extensive power supply voltage range, high measurement accuracy, expandability up to 4 plug in expansion modules. There also is available the DMG 900T measurement transducer which can be used with the DMG 900RD remote display. The DMG 900T, without display, is arranged for mounting inside the panel board, on 35mm DIN rail, and is an ideal solution for installations where the measurements of various multimeters must be remotely viewed. The DMG 900RD remote display connected to the DMG 900T transducer can display the measurements on the panel front while power connections remain inside the panel. Main measurements and functions include:

- Voltage: phase, phase-neutral and ground neutral-earth
- Supply voltage value (only DMG... D048)
- Current: phase values
- Neutral current calculated and true values
- Power: apparent, active and reactive phase and total values
- P.F.: Power Factor per phase and total
- Cosφ per phase and total
- Frequency of measured voltage value
- Voltage and current asymmetry
- Total harmonic distortion (THD) of voltage and current
- Harmonic analysis of voltage and current up to the 63<sup>rd</sup> order
- HIGH-LOW-AVERAGE value functions for all measurements
- Maximum demand of power and current values
- Energy meters for active, reactive, apparent partial and total values with programmable tariff functions
- Hour counter for programmable total and partial hours
- Pulse counter for general use: consumption pulse counting for water, gas, etc., with expansion module only
- Energy quality analysis to EN 50160 Class B (with expansion module).

### Operational characteristics

- Auxiliary supply voltage range: 90...484VAC / 93.5...300VDC for DMG 900 and DMG 900T; 9...70VDC for DMG 900 D048 and DMG 900T D048
  - Voltage measurement range: 20...830VAC phase-to-phase 10...480VAC phase-neutral
  - Usage in medium and high-voltage systems with voltage transformers
  - rated input current: 5A or 1A via CT
  - Current measurement range: 0,05...10A o 0,01...1.2A
  - Current measurements via CT up to 10,000A
  - Frequency measurement range: 45...66Hz / 360...440Hz
  - True RMS measurements for voltage and current values
- Accuracy:
- Voltage: ±0,2% (50...830VAC)
  - Current: ±0,2% (0.1...1.1In)
  - Power: ±0,5% f.s.
  - Power factor: ±0,5%
  - Frequency: ±0,05%
  - Active energy: Class 0.5s (IEC/EN 62053-22)
  - Reactive energy: Class 2 (IEC/EN 62053-23)
- Non-volatile memory for data and event (last 100) storage
  - Communication protocol Modbus-RTU, ASCII and TCP with communication expansion modules only
  - Programming and remote control by software with communication expansion modules only
  - Housing: 96x96mm/3.78"x3.78" flush mount (for DMG 900... and DMG 900RD) and 35mm DIN rail (for DMG 900T...)
  - Degree of protection: IP65 on front for DMG 900 - DMG 900RD; IP20 at terminals for DMG 900 - DMG 900T.

**Synergy** supervision and energy management software See Section 27.

**Xpress** configuration and remote control software See Section 27.

**EXP series expansion modules - See page 28-2.**

### Certifications and compliance

Certifications obtained: EAC for all except DMG M3...; UL Listed, for USA and Canada (cULus - File E93601), as Auxiliary Devices-Multimeters for all except DMG M3... Compliant with standards: IEC/EN 61010-1, IEC/EN 61000-6-2, IEC/EN 61000-6-3, UL 508, CSA C22.2 n°14.



### Flush-mount LED instruments single phase non expandable



DMK 0...

Order code	Displayed measurements	Relay output	Qty per pkg	Wt [kg]
	n°	n°	n°	[kg]

#### Voltmeter.

<b>DMK 00</b>	1 voltage value	–	1	0.290
<b>DMK 00 R1</b> Ⓜ	1 max voltage value 1 min voltage value	1	1	0.323

#### Ammeter.

<b>DMK 01</b>	1 current value	–	1	0.290
<b>DMK 01 R1</b> Ⓜ	1 max current value 1 min current value	1	1	0.323

#### Voltmeter or ammeter.

<b>DMK 02</b> Ⓜ	1 voltage or current value 1 maximum voltage or current value 1 minimum voltage or current value	–	1	0.290
-----------------	--	---	---	-------

#### Frequency meter.

<b>DMK 03</b>	1 frequency value	–	1	0.290
<b>DMK 03 R1</b> Ⓜ	1 max frequency value 1 min frequency value	1	1	0.323

#### Cosphi meter.

<b>DMK 04</b>	1 cosphi value	–	1	0.290
<b>DMK 04 R1</b> Ⓜ	1 power factor value	1	1	0.323

Ⓜ The DMK02 can operate as a voltmeter or ammeter. It is duly equipped with two front plates (V and A) which must be fitted by the user depending on which instrument is required and on the wiring scheme used.

Ⓜ Relay output for control and protection functions.

#### General characteristics

The DMK 0... instruments are available with flush-mount housing, 96x48mm/3.78x1.89". Measurements are True RMS values and provide for reliable operation even in the presence of harmonics.

#### Operational characteristics

- Auxiliary supply voltage: 220-240VAC;
- Operating frequency: 50-60Hz
- True RMS measurements
- Max. and Min. measurement storage
- 1 relay output with 1 changeover contact (for DMK...R1 only)
- Housing: Flush mount 96x48mm/3.78x1.89"
- Terminals: 4mm<sup>2</sup>
- Degree of protection: IP54 on front; IP20 at terminals.

#### DMK 00 - DMK 00 R1

- Voltage measurement range: 15-660VAC
- Operating frequency range: 45-65Hz
- Programmable VT ratio: 1.00-500.00
- Accuracy:  $\pm 0.25\%$  f.s.  $\pm 1$  digit

#### DMK 01 - DMK 01 R1

- Current measurement range: 0.05-5.75A
- Operating frequency range: 45-65Hz
- Programmable CT ratio: 5-10,000
- Accuracy:  $\pm 0.5\%$  f.s.  $\pm 1$  digit

#### DMK 02

- Voltage measurement range: 15-660VAC
- Current measurement range: 0.05-5.75A
- Operating frequency range: 45-65Hz
- Programmable VT ratio: 1.00-500.00
- Programmable CT ratio: OFF/5-10,000
- Accuracy: Voltage  $\pm 0.25\%$  f.s.  $\pm 1$  digit  
Current  $\pm 0.5\%$  f.s.  $\pm 1$  digit

#### DMK 03 - DMK 03 R1

- Measurement input: 15-660VAC
- Frequency measurement range: 15-65Hz
- Accuracy:  $\pm 1$  digit

#### DMK 04 - DMK 04 R1

- Cosphi measurement error:  $\pm 0.5^\circ \pm 1$  digit
- Cosphi measurement in 4 quadrants
- Accuracy:  $\pm 1^\circ \pm 1$  digit

#### Control and protection functions

##### DMK 00 R1

- Voltage loss or failure: OFF/5-85%
- Maximum voltage: OFF/102-120%
- Minimum voltage: OFF/70-98%
- Time delay for max-min voltage or voltage loss, phase loss Ⓜ: 0.0-900.0 seconds.

##### DMK 01 R1

- Current loss: OFF/2-100%
- Maximum current: OFF/102-200%
- Maximum current instantaneous tripping: OFF/110-600%
- Minimum current: OFF/5-98%
- Time delay for max-min current or current loss Ⓜ: 0.0-900.0 seconds.

##### DMK 03 R1

- Maximum frequency: OFF/101-110%
- Minimum frequency: OFF/90-99%
- Time delay for min-max frequency Ⓜ: 0.5-900.0 seconds.

##### DMK 04 R1

- Minimum-maximum  $\cos\phi$  thresholds in 4 quadrants
- Minimum-maximum PF thresholds in 4 quadrants
- Delay time for max or min threshold Ⓜ: 1-9,000 seconds.

#### Certifications and compliance

Certifications obtained: EAC; UL Listed, for USA and Canada (cULus - File E93601), as Auxiliary Devices-Multimeters.

Compliant with standards: IEC/EN 61010-1, IEC/EN 61000-6-2, IEC/EN 61000-6-3, UL 508, CSA C22.2 n° 14.

Ⓜ Independent adjustable delays.

### Flush-mount LED instruments three phase non expandable



DMK 1...

Order code	Displayed measurements	Relay output	Qty per pkg	Wt [kg]
	n°	n°	n°	[kg]
<b>Voltmeter.</b>				
<b>DMK 10</b>	3 phase voltage values	–	1	0.297
<b>DMK 10 R1</b> <sup>Ⓜ</sup>	3 phase to phase voltage values 3 maximum phase voltage values 3 maximum phase to phase voltage values 3 minimum phase voltage values 3 minimum phase to phase voltage values	1	1	0.330
<b>Ammeter.</b>				
<b>DMK 11</b>	3 phase current values	–	1	0.292
<b>DMK 11 R1</b> <sup>Ⓜ</sup>	3 maximum phase current values 3 minimum phase current values	1	1	0.336
<b>Voltmeter, ammeter and wattmeter.</b>				
<b>DMK 15</b>	3 phase voltage values	–	1	0.332
<b>DMK 15 R1</b> <sup>Ⓜ</sup>	3 phase to phase voltage values 3 phase current values 4 active power values, phase and total 3 maximum phase voltage values 3 maximum phase to phase voltage values 3 maximum phase current values 4 maximum active power values, phase and total 3 minimum phase voltage values 3 minimum phase to phase voltage values 3 minimum phase current values 4 minimum active power values, phase and total	1	1	0.350

<sup>Ⓜ</sup> Connection also to single phase.

<sup>Ⓜ</sup> Relay output for control and protection functions.

#### General characteristics

The DMK 1... instruments are available with flush-mount housing, 96x48mm/3.78x1.89". Measurements are TRMS values and provide for reliable operation even in the presence of harmonics.

#### Operational characteristics

- Auxiliary supply voltage: 220-240VAC;
- Operating frequency: 50-60Hz
- TRMS measurements
- Max and Min measurement storage
- 1 relay output with 1 changeover contact (for DMK...R1 only)
- Housing: Flush mount 96x48mm/3.78x1.89"
- Terminals: 4mm<sup>2</sup>
- Degree of protection: IP54 on front; IP20 at terminals.

#### DMK 10 - DMK 10 R1

- Voltage measurement range: 15-660VAC
- Operating frequency range: 45-65Hz
- Programmable VT ratio: 1.00-500.00
- Accuracy: ±0.25% f.s. ±1 digit.

#### DMK 11 - DMK 11 R1

- Current measurement range: 0.05-5.75A
- Operating frequency range: 45-65Hz
- Programmable CT ratio: 5-10,000
- Accuracy: ±0.5% f.s. ±1 digit.

#### DMK 15 - DMK 15 R1

- Voltage measurement range: 35-660VAC
- Current measurement range: 0.05-5.75A
- Frequency measure range: 45-65Hz
- Programmable VT ratio: 1.00-500.00
- Programmable CT ratio: 5-10,000
- Accuracy: Voltage ±0.25% f.s. ±1 digit  
Current ±0.5% f.s. ±1 digit  
Power ±1% f.s. ±1 digit.

#### Control and protection functions

##### DMK 10 R1

- Phase loss or failure: OFF/5-85%
- Maximum voltage: OFF/102-120%
- Minimum voltage: OFF/70-98%
- Asymmetry: OFF/2-20%
- Phase sequence: OFF/L1-L2-L3/L3-L2-L1
- Frequency
  - Maximum frequency: OFF/101-110%
  - Minimum frequency: OFF/90-99%
  - Time delay for max-min voltage, phase loss, asymmetry and min-max frequency <sup>Ⓜ</sup>: 0.5-900.0 seconds.

##### DMK 11 R1

- Current loss: OFF/2-100%
- Maximum current: OFF/102-200%
- Maximum current instantaneous tripping: OFF/110-600%
- Minimum current: OFF/5-98%
- Asymmetry: OFF/2-20%
- Time delay for max-min current or current loss and asymmetry <sup>Ⓜ</sup>: 0.5-900.0 seconds.

##### DMK 15 R1

- Voltage
  - Phase loss or failure: OFF/5-85%
  - Maximum voltage: OFF/102-120%
  - Minimum voltage: OFF/70-98%
  - Asymmetry: OFF/2-20%
  - Phase sequence: OFF/L1-L2-L3/L3-L2-L1
- Current
  - Current loss: OFF/5-85%
  - Maximum current: OFF/102-200%
  - Maximum current instantaneous tripping: OFF/110-600%
  - Minimum current: OFF/5-98%
  - Asymmetry: OFF/2-20%
- Power
  - Rated power: 1-10,000
  - Maximum power: OFF/101-200%
  - Max. power instantaneous tripping: OFF/110-600%
  - Minimum power: OFF/10-99%
- Frequency
  - Maximum frequency: OFF/101-110%
  - Minimum frequency OFF/90-99%
  - Time delay for max-min voltage, max-min current or current loss, phase loss, asymmetry and min-max power <sup>Ⓜ</sup>: 0.0-900.0 seconds.

#### Certifications and compliance

Certifications obtained: EAC; UL Listed, for USA and Canada (cULus - File E93601), as Auxiliary Devices-Multimeters.

Compliant with standards: IEC/EN 61010-1, IEC/EN 61000-6-2, IEC/EN 61000-6-3, UL 508, CSA C22.2 n° 14.

<sup>Ⓜ</sup> Independent adjustable delays.

### Flush-mount LED multimeter three phase non expandable



DMK 16

Order code	Displayed measurements	Qty per pkg	Wt
		n°	[kg]
DMK 16	3 phase voltage values 3 phase to phase voltage values 3 phase current values 4 active power values, phase and total 4 reactive power values, phase and total 4 apparent power values, phase and total 3 phase power factor values 1 frequency value 1 active energy value in kWh 1 reactive energy value in kvarh 1 hour counter 3 maximum phase voltage values 3 maximum phase to phase voltage values 3 maximum phase current values 4 maximum active power values, phase and total 4 maximum reactive power values, phase and total 4 maximum apparent power values, phase and total 3 minimum phase voltage values 3 minimum phase to phase voltage values 3 minimum phase current values 4 minimum active power values, phase and total 4 minimum reactive power values, phase and total 4 minimum apparent power values, phase and total	1	0.350

#### General characteristics

The DMK 16 multimeter is available with flush-mount housing, 96x48mm/3.78x1.89". Measurements are True RMS values and provide for reliable operation even in the presence of harmonics.

#### Operational characteristics

- Auxiliary supply voltage: 220-240VAC;
- Operating frequency: 50-60Hz
- True RMS measurements
- Accuracy: Voltage  $\pm 0.25\%$  f.s.  $\pm 1$  digit  
Current  $\pm 0.5\%$  f.s.  $\pm 1$  digit
- Active energy accuracy: Class 2 (IEC/EN 62053-21 and IEC/EN 62053-23)
- Max and Min measurement storage
- Voltage measurement range: 35-660VAC
- Current measurement range: 0.05-5.75A
- Operating frequency range: 45-65Hz
- Programmable VT ratio: 1.00-500.0
- Programmable CT ratio: 5-10,000
- Housing: Flush mount 96x48mm/3.78x1.89"
- Terminals: 4mm<sup>2</sup>
- Degree of protection: IP54 on front; IP20 at terminals.

#### Certifications and compliance

Certifications obtained: EAC; UL Listed, for USA and Canada (cULus - File E93601), as Auxiliary Devices-Multimeters.

Compliant with standards: IEC/EN 61010-1, IEC/EN 61000-6-2, IEC/EN 61000-6-3, UL508, CSA C22.2 n° 14.

### Flush-mount LED multimeter three phase non expandable



DMK 16 R1

Order code	Description	Qty per pkg	Wt
		n°	[kg]
DMK 16 R1 <sup>①</sup>	3 phase voltage values 3 phase to phase voltage values 3 phase current values 4 active power values, phase and total 4 reactive power values, phase and total 4 apparent power values, phase and total 3 phase power factor values 1 frequency value 1 active energy value in kWh 1 reactive energy value in kvarh 1 hour counter 3 maximum phase voltage values 3 maximum phase to phase voltage values 3 maximum phase current values 4 maximum active power values, phase and total 4 maximum reactive power values, phase and total 4 maximum apparent power values, phase and total 3 minimum phase voltage values 3 minimum phase to phase voltage values 3 minimum phase current values 4 minimum active power values, phase and total 4 minimum reactive power values, phase and total 4 minimum apparent power values, phase and total 2 minimum and maximum power factor values	1	0.350

① Connection also to single phase.

#### General characteristics

The DMK 16 R1 multimeter is available with flush-mount housing, 96x48mm/3.78x1.89"  
 Measurements are True RMS values and provide for reliable operation even in the presence of harmonics.

#### Operational characteristics

- Auxiliary supply voltage: 220-240VAC
- Operating frequency: 50-60Hz
- True RMS measurements
- Accuracy: Voltage  $\pm 0.25\%$  f.s.  $\pm 1$  digit  
 Current  $\pm 0.5\%$  f.s.  $\pm 1$  digit
- Active energy accuracy: Class 2 (IEC/EN 62053-21 and IEC/EN 62053-23)
- Max and Min measurement storage
- Voltage measurement range: 35-660VAC
- Current measurement range: 0.05-5.75A
- Frequency measurement range: 45-65Hz
- Programmable VT ratio: 1.00-500.0
- Programmable CT ratio: 5-10,000
- 1 relay output with 1 changeover (SPDT) contact
- Housing: Flush mount 96x48mm/3.78x1.89"
- Terminals: 4mm<sup>2</sup>
- Degree of protection: IP54 on front; IP20 at terminals.

#### PROGRAMMABLE RELAY OUTPUT

- Voltage
  - Phase loss or failure: OFF/5-85%
  - Maximum voltage: OFF/102-120%
  - Minimum voltage: OFF/70-98%
  - Asymmetry: OFF/2-20%
  - Phase sequence: OFF/L1-L2-L3/L3-L2-L1
- Current
  - Protection inhibition max current: OFF/2-100%
  - Maximum current: OFF/102-200%
  - Maximum current instantaneous tripping: OFF/110-600%
  - Minimum current: OFF/5-98%
  - Asymmetry: OFF/2-20%
- Power factor
  - Maximum power factor: 0.10-1.00
  - Minimum power factor: 0.10-1.00
- Time delay for max-min voltage, max-min current or current loss, phase loss, asymmetry and min-max power factor  $\theta$ : 0.0-900.0 seconds.

#### Certifications and compliance

Certifications obtained: EAC; UL Listed, for USA and Canada (cULus - File E93601), as Auxiliary Devices-Multimeters.

Compliant with standards: IEC/EN 61010-1, IEC/EN 61000-6-2, IEC/EN 61000-6-3, UL 508, CSA C22.2 n° 14.

② Independent adjustable delays.



### Flush mount LED multimeters non expandable 47 electrical parameters



DMK 2...

Order code	Description	Qty per pkg.	Wt
		n°	[kg]
DMK 20	Basic version, auxiliary supply 208...240VAC	1	0.434
DMK 21	Version with energy meters included, auxiliary supply 208...240VAC	1	0.477
DMK 22	Version with energy meters and RS485 port included, auxiliary supply 208...240VAC	1	0.477

#### General characteristics

DMK 2... digital multimeters are available with flush-mount housing, 96x96mm/3.78x3.78". They monitor and view reliable readings of electrical parameters, even in the presence of critical operating conditions, such as voltages and currents with high harmonic content and variable frequency.

The total and partial hour counter provides an interesting feature for electric panels of emergency generating sets. The diversified and accurate measurements give the multimeters valuable technical and cost effective advantages with respect to traditional analog instrumentation.

DMK2... digital multimeters view 47 electrical parameters:

- Voltage: phase, line and system values
- Current: phase values
- Power: active and reactive values, apparent phase.
- P.F.: power factor per phase
- Frequency (measured voltage frequency)
- HIGH/LOW: instantaneous minimum and maximum values of each phase voltage and current, total active power ( $\Sigma W$ ), total reactive power ( $\Sigma var$ ) and total apparent power ( $\Sigma VA$ ) values
- Total hours: non-volatile clearable log for DMK 20
- Partial hours: non-volatile configurable log for DMK 20
- Active and reactive energy meters for DMK21 and DMK22 only.

#### Operational characteristics

- Auxiliary supply voltage range:
  - 154-288VAC for DMK 20
  - 177-264VAC for DMK 21-DMK 22
- Voltage measurement range: 60-830VAC phase-phase  
30-480VAC phase-neutral
- Current measurement range: 0.05-6A
- Frequency measurement range: 45-65Hz
- Programmable CT ratio: 1.0-2,000
- Voltage accuracy: Class 0.5  $\pm$ 0.35% f.s. (830V)
- Current accuracy: Class 0.5  $\pm$ 0.5% f.s. (6A)
- Active energy accuracy: Class 2
- Total and partial hour counter (can be used as maintenance with optical alarm and separate resetting) (DMK 20)
- HIGH and LOW value functions to read and log instantaneous voltage, current and power values
- Delayed automatic resetting of default measurements
- Averaging function to slow down repetitive fluctuations to obtain more stable readouts
- Current connection in ARON configuration by 2 current transformers (CTs) only
- Single, two, three phase, with or without neutral,
- TRMS measurements
- RS485 serial port, compatible with **Synergy** software for DMK 22
- Housing: Flush mount 96x96mm/3.78x3.78"
- Degree of protection: IP54 on front; IP20 at terminals.

**Synergy** supervision and energy management software  
See Section 27.

#### Certifications and compliance

Certifications obtained: EAC; UL Listed, for USA and Canada (cULus - File E93601), as Auxiliary Devices-Multimeters.

Compliant with standards: IEC/EN 61010-1, IEC/EN 61000-6-2, IEC/EN 61000-6-3, UL508, CSA C22.2 n°14.

### Modular LED instruments single phase non expandable



DMK 80

DMK 80 R1



DMK 81

DMK 81 R1



DMK 82

DMK 82



DMK 83

DMK 83 R1



DMK 84

DMK 84 R1

Order code	Displayed measurements	Relay output	Qty per pkg	Wt [kg]
	n°	n°	n°	[kg]

Voltmeter.

<b>DMK 80</b>	1 voltage value	–	1	0.237
<b>DMK 80 R1</b> Ⓜ	1 max voltage value 1 min voltage value	1	1	0.268

Ammeter.

<b>DMK 81</b>	1 current value	–	1	0.237
<b>DMK 81 R1</b> Ⓜ	1 max current value 1 min current value	1	1	0.268

Voltmeter or ammeter.

<b>DMK 82</b> Ⓜ	1 voltage or current value 1 maximum voltage or current value 1 minimum voltage or current value	–	1	0.241
-----------------	--	---	---	-------

Frequency meter.

<b>DMK 83</b>	1 frequency value	–	1	0.237
<b>DMK 83 R1</b> Ⓜ	1 max frequency value 1 min frequency value	1	1	0.268

Cosphi meter.

<b>DMK 84</b>	1 cosphi value	–	1	0.241
<b>DMK 84 R1</b> Ⓜ	1 power factor value	1	1	0.272

Ⓜ The DMK82 can operate as a voltmeter or ammeter. It is duly equipped with two front plates (V and A) which must be fitted by the user depending on which instrument is required and on the wiring scheme used.

Ⓜ Relay output with control and protection functions.

#### General characteristics

The DMK 8... instruments are available with modular housing, 3 module size. Measurements are True RMS values and provide for reliable operation even in the presence of harmonics.

#### Operational characteristics

- Auxiliary supply voltage: 220-240VAC
- Operating frequency: 50-60Hz
- True RMS measurements
- Max and Min measurement storage
- 1 relay output with 1 changeover contact (SPDT) for DMK...R1 version only
- Modular DIN 43880 housing, 3 modules
- Terminals: 4mm<sup>2</sup>
- Degree of protection: IP40 on front; IP20 on terminals.

#### DMK 80 - DMK 80 R1

- Voltage measurement range: 15-660VAC
- Operating frequency range: 45-65Hz
- Programmable VT ratio: 1.00-500.00
- Accuracy: ±0.25% f.s. ±1 digit

#### DMK 81 - DMK 81 R1

- Current measurement range: 0.05-5.75A
- Operating frequency range: 45-65Hz
- Programmable CT ratio: 5-10,000
- Accuracy: ±0.5% f.s. ±1 digit

#### DMK 82

- Voltage measurement range: 15-660VAC
- Current measurement range: 0.05-5.75A
- Operating frequency range: 45-65Hz
- Programmable VT ratio: 1.00-500.00
- Programmable CT ratio: OFF/5-10,000
- Accuracy: Voltage ±0.25% f.s. ±1 digit
- Accuracy: Current ±0.5% f.s. ±1 digit

#### DMK 83 - DMK 83 R1

- Measurement input: 15-660VAC
- Frequency measurement range: 50-60Hz ±10%
- Measurement accuracy: ±1 digit
- Accuracy: ±1 digit

#### DMK 84 - DMK 84 R1

- Cosphi measurement error: ±0.5° ±1 digit
- Cosphi measurement in 4 quadrants
- Accuracy: ±1° ±1 digit

#### Control and protection functions

##### DMK 80 R1

- Voltage loss or failure: OFF/5-85%
- Maximum voltage: OFF/102-120%
- Minimum voltage: OFF/70-98%
- Time delay for max-min voltage or voltage loss Ⓜ: 0.0-900.0 seconds.

##### DMK 81 R1

- Current loss: OFF/2-100%
- Maximum current: OFF/102-200%
- Maximum current instantaneous tripping: OFF/110-600%
- Minimum current: OFF/5-98%
- Time delay for max-min current or current loss Ⓜ: 0.0-900.0 seconds.

##### DMK 83 R1

- Maximum frequency: OFF/101-110%
- Minimum frequency: OFF/90-99%
- Time delay for min-max frequency Ⓜ: 0.5-900.0 seconds.

##### DMK 84 R1

- Minimum-maximum cosφ thresholds in 4 quadrants
- Minimum-maximum PF thresholds in 4 quadrants
- Delay time for max or min threshold Ⓜ: 1-9,000 seconds.

#### Certifications and compliance

Certifications obtained: EAC.

Compliant with standards: IEC/EN 61010-1, IEC/EN 61000-6-2, IEC/EN 61000-6-3.

Ⓜ Independent adjustable delays.

### Modular LED instruments three phase non expandable



DMK 70

DMK 70 R1



DMK 71

DMK 71 R1



DMK 75

DMK 75 R1

Order code	Displayed measurements	Relay output	Qty per pkg	Wt
	n°	n°	n°	[kg]
Voltmeter.				
DMK 70	3 phase voltage values	–	1	0.233
DMK 70 R1 <sup>Ⓜ</sup>	3 phase to phase voltage values 3 max phase voltage values 3 max phase to phase voltage values 3 min phase voltage values 3 min phase to phase voltage values	1	1	0.264
Ammeter.				
DMK 71	3 phase current values	–	1	0.241
DMK 71 R1 <sup>Ⓜ</sup>	3 max phase current values 3 min phase current values	1	1	0.272
Combined voltmeter, ammeter and wattmeter.				
DMK 75	3 phase voltage values	–	1	0.271
DMK 75 R1 <sup>ⓂⓈ</sup>	3 phase to phase voltage values 3 phase current values 4 active power values, phase and total 3 maximum phase voltage values 3 maximum phase to phase voltage values 3 maximum phase current values 4 max active power, phase and total 3 minimum phase voltage values 3 minimum phase to phase voltage values 3 minimum phase current values 4 min active power, phase and total	1	1	0.280

- <sup>Ⓜ</sup> Connection also to single phase.  
<sup>Ⓢ</sup> Relay output with control and protection functions.

#### General characteristics

The DMK 7... instruments are available with modular housing, 3 module size. Measurements are True RMS values and provide for reliable operation even in the presence of harmonics.

#### Operational characteristics

- Auxiliary supply voltage: 220-240VAC
- Operating frequency: 50-60Hz
- True RMS measurements
- Max and Min measurement storage
- 1 relay output with 1 changeover contact (SPDT) for DMK...R1 version only
- Modular DIN 43880 housing, 3 module
- Terminals: 4mm<sup>2</sup>
- Degree of protection: IP40 on front; IP20 on terminals.

#### DMK 70 - DMK 70 R1

- Voltage measurement range: 15-660VAC
- Operating frequency range: 45-65Hz
- Programmable VT ratio: 1.00-500.00
- Accuracy: ±0.25% f.s. ±1 digit

#### DMK 71 - DMK 71 R1

- Current measurement range: 0.05-5.75A
- Operating frequency range: 45-65Hz
- Programmable CT ratio: 5-10,000
- Accuracy: ±0.5% f.s. ±1 digit

#### DMK 75 - DMK 75 R1

- Voltage measurement range: 35-660VAC
- Current measurement range: 0.05-5.75A
- Frequency measure range: 45-65Hz
- Programmable VT ratio: 1.00-500.00
- Programmable CT ratio: 5-10,000
- Accuracy: Voltage ±0.25% f.s. ±1 digit
- Accuracy: Current ±0.5% f.s. ±1 digit

#### Control and protection functions

##### DMK 70 R1

- Phase loss or failure: OFF/5-85%
- Maximum voltage: OFF/102-120%
- Minimum voltage: OFF/70-98%
- Asymmetry: OFF/2-20%
- Phase sequence: OFF/L1-L2-L3/L3-L2-L1
- Maximum frequency: OFF/101-110%
- Minimum frequency: OFF/90-99%
- Time delay for max-min voltage, phase loss, asymmetry and min-max frequency <sup>Ⓢ</sup>: 0.0-900.0 seconds.

##### DMK 71 R1

- Current loss: OFF/2-100%
- Maximum current: OFF/102-200%
- Maximum current instantaneous tripping: OFF/110-600%
- Minimum current: OFF/5-98%
- Asymmetry: OFF/2-20%
- Time delay for max-min current or current loss and asymmetry <sup>Ⓢ</sup>: 0.0-900.0 seconds.

##### DMK 75 R1

###### Voltage

- Phase loss or failure: OFF/5-85%
- Maximum voltage: OFF/102-120%
- Minimum voltage: OFF/70-98%
- Asymmetry: OFF/2-20%
- Phase sequence: OFF/L1-L2-L3/L3-L2-L1

###### Current

- Current loss: OFF/2-100%
- Maximum current: OFF/102-200%
- Maximum current instantaneous tripping: OFF/110-600%
- Minimum current: OFF/5-98%
- Asymmetry: OFF/2-20%

###### Power

- Rated power: 1-10,000
- Maximum power: OFF/101-200%
- Maximum power instantaneous tripping: OFF/110-600%
- Minimum power: OFF/10-99%

###### Frequency

- Maximum frequency: OFF/101-110%
- Minimum frequency: OFF/90-99%
- Time delay for max-min voltage, max-min current or current loss, phase loss, asymmetry and min-max power <sup>Ⓢ</sup>: 0.0-900.0 seconds.

#### Certifications and compliance

Certifications obtained: EAC.

Compliant with standards: IEC/EN 61010-1, IEC/EN 61000-6-2, IEC/EN 61000-6-3.

- <sup>Ⓢ</sup> Independent adjustable delays.

### Communication devices



CX 01



CX 02



CX 03

Order code	Description	Qty per pkg	Wt
		n°	[kg]
<b>CX 01</b>	USB/optical dongle with PC ↔ LOVATO Electric product connecting cable, for programming, data download, diagnostics and firmware upgrade	1	0.090
<b>CX 02</b>	Wi-Fi dongle for PC ↔ LOVATO Electric product programming, data download, diagnostics and cloning	1	0.090
<b>CX 03</b>	GSM/GPRS penta-band antenna (850/900/1800/1900/2100Mhz) for EXP1015 expansion module	1	0.090

#### General characteristics

Communication devices for connection of LOVATO Electric products to personal computers, smartphones and tablets.

#### CX 01

The USB/optical dongle, complete with cable, allows the connection of products compatible with PCs without having to disconnect the power supply from the electric panel.

The PC identifies the connection as a standard USB.

#### CX 02

By Wi-Fi connection, compatible LOVATO Electric products can be viewed on PCs, smartphones and tablets with no need for cabling.

#### CX 03

Antenna compatible with the major part of worldwide mobile networks thanks to the available frequencies at 850/900/1800/1900/2100MHz.

Degree of protection: IP67. Fixing by Ø10mm drilling. Cable length: 2.5mm

For dimensions, wiring schemes and technical characteristics, refer to technical instructions in the Downloads section at:

[www.LovatoElectric.com](http://www.LovatoElectric.com)

### Protection covers



31 PA96x96

Order code	Description	Qty per pkg	Wt
		n°	[kg]
<b>PA 96X48</b>	Front protection cover, IEC IP65 for DMK 0/1...	1	0.048
<b>31 PA 96X96</b>	Front protection cover, IEC IP54 for DMK 2...	1	0.077

#### General characteristics

When a higher front IP protection degree is needed, the covers can be installed on the corresponding devices and also provide a sealing feature.

### Accessories



EXP80 00

Order code	Description	Qty per pkg	Wt
		n°	[kg]
<b>EXP80 00</b>	Plastic insert for customising label fixing for DMG 600/610	10	0.005
<b>EXM80 04</b>	Set of sealable terminal covers for DMG 100/101/110/200/210/300	1	0.020

### Converter



EXC CON 01



Order code	Description	Qty per pkg.	Wt
		n°	[kg]
EXC CON 01	RS485/Ethernet 12...48VDC converter, including DIN rail fixing kit	1	0.400
4 PX1	RS232/RS485 galvanically isolated converter supply 220...240VAC (or 110...120VAC). Repeater for bus extension RS485	1	0.600



4 PX1

### Gateway



EXC M3G 01



Order code	Description	Qty per pkg.	Wt
		n°	[kg]
EXC M3G 01	RS485/3G modem, 9.5...27VAC/9.5...35VDC, including antenna and programming cable, length 2.5m	1	0.340

### Connecting cables



51 C4

Order code	Description	Qty per pkg.	Wt
		n°	[kg]
51 C2	For PC-multimeter RS232 port, 1.8m long	1	0.090
51 C4	For PC-4 PX1 converter drive, 1.8m long	1	0.147
51 C5	For analog modem-multimeter RS232 port, 1.8m long	1	0.111
51 C9	For 4PX 1 converter drive-analog modem, 1.8m long	1	0.137

Current clamp kits for DMG M3... portable devices



DMG M3 KIT...

DMG M3 KIT01	Composed by 3 current clamps 1000/1 and 4 alligator clip cables for voltage measurements	1	6.900
DMG M3 KIT02	Composed by 1 current clamps 1000/1 and 1 alligator clip cable for voltage measurements. For DMGM3900, if measuring inputs for neutral-earth/ground and neutral current are used too	1	0.860

#### General characteristics

##### EXC CON 01 CONVERTER

The EXC CON 01 converter allows "Slave" devices connected on an RS485 network to interface with a "Master" featuring Ethernet port:

- kit comprising converter and DIN rail mounting accessory;
- programming via web interface;
- power supply not included.

##### 4 PX1 CONVERTER (RS232-RS485)

It can interface "Slave" devices connected in an RS485 bus with a "Master" equipped with RS232 interface port. When configured appropriately, it can also be used as RS485 repeater whenever the devices connected to the bus are many or the maximum distance among the bus devices is longer than the allowed.

##### EXC M3G 01 GATEWAY

The EXC M3G 01 gateway allows "Slave" devices connected on an RS485 network to interface with a "Master" via 3G network:

- TCP server connection via 3G or 2G network;
- Transparent operating mode: the data is transferred from 3G side to serial side and vice versa without protocol conversion;
- Parameters that can be set: TCP server remote port and IP, network operator APN (with username and password), SIM card PIN (with enablement), connection timeout, serial parameters (baud rate from 1200bps to 115200bps, stop bit, number of characters, parity);
- RJ45 port for parameter programming and diagnosis with a simple software application.
- Compatible with major worldwide mobile phone networks, thanks to the use of 850/900/1800/1900/2100MHz frequencies. Protection rating IP67. Fixing hole Ø10mm. Cable length 2.5m.

#### CONNECTING CABLES 51 C...

To connect energy meters and/or multimeters with:

- Personal computers
- Modems
- Bus converters.

#### Electrical safety for DMG M3 KIT...

(IEC/EN 61010-1 and IEC/EN 611-2-032)

##### CURRENT CLAMPS

- 600V category III
- 300V category IV.

##### VOLTAGE MEASURING CABLES

- 1000V category III.

#### Reference standards

Compliant with standards: IEC/EN 61010-1, IEC/EN 61000-6-2, IEC/EN 61000-6-3.

For dimensions, wiring schemes and technical characteristics, refer to technical instructions in Downloads at [www.LovatoElectric.com](http://www.LovatoElectric.com).



### Solid-core



DMOT...



DM2T...



DM3T...



DM35T...



DM4T...

Order code	Primary current I <sub>pn</sub>	Burden		Qty per pkg.	Weight [kg]
		cl. 0.5 [VA]	cl. 1 [VA]		

For Ø22mm/0.87" cable.

DMOT 0050	50	—	1.25	1	0.200
DMOT 0060	60	—	1.5	1	0.200
DMOT 0080	80	—	1.5	1	0.200
DMOT 0100	100	—	1.5	1	0.200
DMOT 0150	150	—	2	1	0.200

For Ø23mm/0.90" cable.

For 30x10mm/1.18x0.39", 25x12.5mm/0.98x0.49",  
20x15mm/0.79x0.59" busbars.

DM2T 0100	100	—	1	1	0.130
DM2T 0150	150	—	1.5	1	0.130
DM2T 0200	200	—	2	1	0.130
DM2T 0250	250	—	2.5	1	0.130
DM2T 0300	300	1.5	3	1	0.130
DM2T 0400	400	2	3	1	0.130

For Ø30mm/1.18" cable.

For 40x10mm/1.57x0.39", 30x20mm/1.18x0.79",  
25x25mm/0.98x0.98" busbars.

DM3T 0200	200	—	5	1	0.260
DM3T 0250	250	—	5	1	0.260
DM3T 0300	300	2.5	5	1	0.260
DM3T 0400	400	2.5	5	1	0.260
DM3T 0500	500	2.5	5	1	0.260
DM3T 0600	600	5	10	1	0.260
DM3T 0800	800	5	10	1	0.260

For Ø66mm/2.60" cable.

For 80x12,5mm/3.15"x0.49", 60x30mm/2.36x1.18",  
50x50mm/1.97x1.97" busbars.

DM35T 0800	800	10	15	1	0.460
DM35T 1000	1000	15	20	1	0.460
DM35T 1250	1250	15	20	1	0.460

For Ø86mm/3.38" cable.

For 100x30mm/3.94x1.18", 80x50mm/3.15x1.97",  
70x60mm/2.75x2.36" busbars.

DM4T 1000	1000	10	20	1	0.700
DM4T 1250	1250	15	30	1	0.760
DM4T 1500	1500	20	30	1	0.760
DM4T 1600	1600	20	30	1	0.800
DM4T 2000	2000	30	45	1	0.840
DM4T 2500	2500	35	45	1	0.900
DM4T 3000	3000	45	45	1	0.900
DM4T 3500	3500	50	50	1	0.900
DM4T 4000	4000	50	50	1	0.900

new

### General characteristics

The current transformers (CTs) in the DM series are installed in an electrical system to reduce the line current to a secondary value of 5A compatible with the ammeter inputs of the digital multimeters or protection relays. DM... are instrument transformers in class 1/0.5 without a primary winding and are normally used for high primary current values starting from 50A.

The number of loops of the primary cable does not modify the accuracy but converts the primary current value proportional to secondary current.

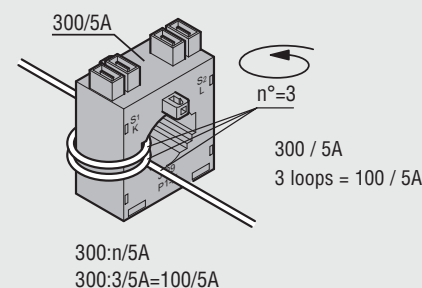
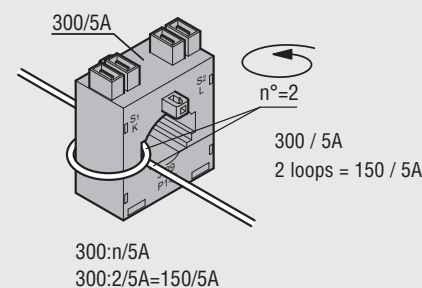
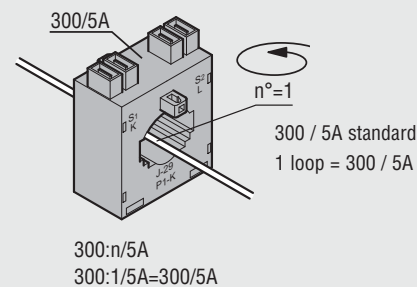

### Operational characteristics

- Operating frequency: 50-60Hz
- Secondary output current: 5A
- Overload withstand: 120% I<sub>pn</sub>
- IEC rated insulation voltage U<sub>i</sub>: 720V
- IEC rated short-time thermal current I<sub>th</sub>: 40-60 I<sub>pn</sub> for 1 second
- IEC rated dynamic current I<sub>dyn</sub>: 2.5 I<sub>th</sub> for 1 second
- Insulation (dry type): Class E
- Terminals:
  - Faston for DM2T and DM3T types
  - Screw for DMOT, DM4T and DM35T types
- Sealable terminal covers for DM4T and DM35T types
- Fixing on 35mm DIN rail (IEC/EN 60715) or by screws (fixing elements standard supplied with the product)
- IEC degree of protection: IP30
- Ambient conditions
  - Operating temperature: -25 ... +50°C
  - Storage temperature: -40 ... +80°C.
  - Relative humidity, non condensing: 90%.

### Reference standards

Compliant with standards: IEC/EN 61869-2,  
IEC/EN 61869-1.

### Accuracy solid-core



DM1TP...

**new**



DM3TP...

**new**



DM5TP...

**new**

Versions with Italian UTF certificates on request.

Order code	Primary current I <sub>pn</sub>	Burden		Qty per pkg.	Weight
		cl. 0.5s	cl. 0.5		
	/5 [A]	[VA]	[VA]	n°	[kg]

For Ø28mm/1.10" <sup>①</sup> cable.  
For 30x10mm/1.18x0.39", 25x12.5mm/0.98x0.49",  
20x20mm/0.79x0.79" busbar.

DM1TP 0060	60	1.5	1.5	1	0.560
DM1TP 0080	80	2,5	2,5	1	0.580
DM1TP 0100	100	2.5	3.75	1	0.480
DM1TP 0150	150	2.5	3.75	1	0.480
DM1TP 0200	200	2.5	3.75	1	0.480
DM1TP 0250	250	2.5	5	1	0.480
DM1TP 0300	300	2.5	5	1	0.480
DM1TP 0400 <sup>②</sup>	400	5	5	1	0.480
DM1TP 0500 <sup>②</sup>	500	5	5	1	0.480

For Ø52mm2.04" <sup>①</sup> cable.  
For 60x20mm/2.36x0.79", 50x25mm/1.97x0.98" busbar.

DM3TP 0500	500	3.75	5	1	0.700
DM3TP 0600	600	5	10	1	0.700
DM3TP 0800	800	5	10	1	0.700
DM3TP 1000	1000	5	10	1	0.700

For Ø66mm/2.60" <sup>①</sup> cable.  
For 100x20mm/3.94x0.79", 80x45mm/3.15x1.77" busbar.

DM5TP 1000	1000	5	10	1	0.900
DM5TP 1250	1250	7.5	10	1	0.900
DM5TP 1600	1600	7.5	10	1	0.900
DM5TP 2000	2000	10	15	1	0.900
DM5TP 2500	2500	10	15	1	0.900
DM5TP 3000	3000	10	15	1	0.900

<sup>①</sup> Consult Customer Service to inquiry about versions with Italian UTF certificates.

<sup>②</sup> For Ø33mm cable. For 40x10mm, 30x20mm, 25x25mm busbar.

### General characteristics

The DM...TP type accuracy current transformers (CTs) are installed in an electrical system to reduce the line current to a secondary value of 5A compatible with the ammeter inputs of the digital multimeters or protection relays. DM...TP are accuracy current transformers in class 0.5s without a primary winding and are normally used for high primary current values starting from 60A. The number of loops of the primary cable does not modify the accuracy but converts the primary current value proportional to secondary current.

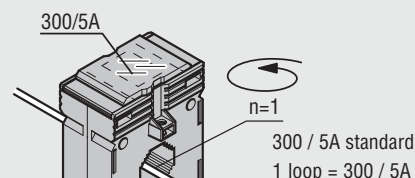

300:n/5A  
300:1/5A=300/5A

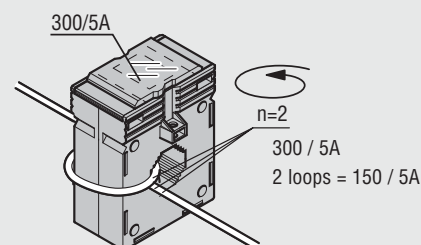

300:n/5A  
300:3/5A=100/5A

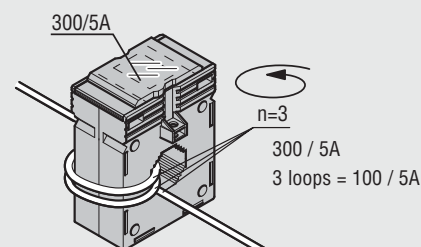

300:n/5A  
300:3/5A=100/5A

### Operational characteristics

- Operating frequency: 50-60Hz
- Secondary output current: 5A
- Overload withstand: 120% I<sub>pn</sub>
- IEC rated insulation voltage U<sub>i</sub>: 720V
- IEC rated short-time thermal current I<sub>th</sub>: 40-60 I<sub>pn</sub> for 1 second
- IEC rated dynamic current I<sub>dyn</sub>: 2.5 I<sub>th</sub> for 1 second
- Insulation (dry type): Class E
- Screw terminals
- Sealable terminal covers
- Fixing on 35mm DIN rail (IEC/EN 60715) or by screws (fixing elements standard supplied with the product)
- IEC degree of protection: IP30
- Ambient conditions
  - Operating temperature: -25 ... +50°C
  - Storage temperature: -40 ... +80°C.
  - Relative humidity, non condensing: 90%.

### Reference standards

Compliant with standards: IEC/EN 61869-2, IEC/EN 61869-1.



### Compact prewired split-core



DM1TMA...



DM2TMA...



Order code	Primary current I <sub>pn</sub>	Burden		Qty per pkg.	Weight [kg]
		cl. 0.5	cl. 1		
	/5 [A]	[VA]	[VA]	n°	

24x24mm/0.94x0.94" hole. Cable supplied as standard, length 1m.

<b>DM1TMA 0100</b>	100	—	1.2	1	0.200
<b>DM1TMA 0150</b>	150	—	1.2	1	0.200
<b>DM1TMA 0200</b>	200	—	1.2	1	0.200
<b>DM1TMA 0250</b>	250	—	1.2	1	0.200

36x38mm/1.42x1.50" hole. Cable supplied as standard, length 1m.

<b>DM2TMA 0250</b>	250	—	1.5	1	0.380
<b>DM2TMA 0300</b>	300	—	1.5	1	0.380
<b>DM2TMA 0400</b>	400	—	1.5	1	0.380
<b>DM2TMA 0500</b>	500	—	1.5	1	0.380

#### General characteristics

The DM...TMA type current transformers (CTs) are installed in an electrical system to reduce the line current to a secondary value of 5A compatible with the ammeter inputs of the digital multimeters or protection relays. DM...TMA are instrument transformers in class 1 without a primary winding and are normally used for high primary current values starting from 100A.

#### Operational characteristics

- Operating frequency: 50-60Hz
- Secondary output current: 5A
- Overload withstand: 120% I<sub>pn</sub>
- IEC rated insulation voltage U<sub>i</sub>: 720V
- IEC rated short-time thermal current I<sub>th</sub>: 40-60 I<sub>pn</sub> for 1 second
- IEC rated dynamic current I<sub>dyn</sub>: 2.5 I<sub>th</sub> for 1 second
- Cable supplied as standard, length 1m.
- Insulation (dry type): Class E
- Ambient conditions:
  - Operating temperature: -25...+50°C
  - Storage temperature: -40...+80°C
  - Relative humidity, non condensing: 90%.

#### Reference standards

Compliant with standards: IEC/EN 61869-2, IEC/EN 61869-1.

### Split-core



DM1TA...



DM2TA...



DM3TA...



DM4TA...

Order code	Primary current I <sub>pn</sub>	Burden		Qty per pkg.	Weight [kg]
		cl. 0.5	cl. 1		
	/5 [A]	[VA]	[VA]	n°	

50x80mm/1.97x3.15" hole.

<b>DM1TA 0250</b>	250	1	2	1	0.900
<b>DM1TA 0300</b>	300	1.5	3	1	0.900
<b>DM1TA 0400</b>	400	1.5	3	1	0.900
<b>DM1TA 0500</b>	500	2.5	5	1	0.900
<b>DM1TA 0600</b>	600	2.5	5	1	0.900
<b>DM1TA 0800</b>	800	3	7.5	1	0.900
<b>DM1TA 1000</b>	1000	5	10	1	0.900

80x80mm/3.15x3.15" hole.

<b>DM2TA 0250</b>	250	1	2	1	1.050
<b>DM2TA 0300</b>	300	1.5	3	1	1.050
<b>DM2TA 0400</b>	400	1.5	3	1	1.050
<b>DM2TA 0500</b>	500	2.5	5	1	1.050
<b>DM2TA 0600</b>	600	2.5	5	1	1.050
<b>DM2TA 0800</b>	800	3	7.5	1	1.050
<b>DM2TA 1000</b>	1000	5	10	1	1.050

80x120mm/3.15x4.72" hole.

<b>DM3TA 0500</b>	500	—	4	1	1.250
<b>DM3TA 0600</b>	600	—	5	1	1.250
<b>DM3TA 0800</b>	800	3	7.5	1	1.250
<b>DM3TA 1000</b>	1000	5	10	1	1.250
<b>DM3TA 1250</b>	1250	7.5	15	1	1.250
<b>DM3TA 1500</b>	1500	8	17	1	1.250

80x160mm/3.15x6.30" hole.

<b>DM4TA 2000</b>	2000	15	20	1	3.160
<b>DM4TA 2500</b>	2500	15	20	1	3.340
<b>DM4TA 3000</b>	3000	20	25	1	3.500
<b>DM4TA 4000</b>	4000	20	25	1	3.760

#### General characteristics

The DM...TA type current transformers (CTs) are installed in an electrical system to reduce the line current to a secondary value of 5A compatible with the ammeter inputs of the digital multimeters or protection relays. DM...TA are instrument transformers in class 0.5/1 without a primary winding and are normally used for high primary current values starting from 250A.

#### Operational characteristics

- Operating frequency: 50-60Hz
- Secondary output current: 5A
- Overload withstand: 120% I<sub>pn</sub>
- IEC rated insulation voltage U<sub>i</sub>: 720V
- IEC rated short-time thermal current I<sub>th</sub>: 40-60 I<sub>pn</sub> for 1 second
- IEC rated dynamic current I<sub>dyn</sub>: 2.5 I<sub>th</sub> for 1 second
- Insulation (dry type): Class E
- Screw terminals
- Sealable terminal covers
- Screw fixing (fixing elements standard supplied with the product)
- IEC degree of protection: IP30
- Ambient conditions:
  - Operating temperature: -25 ... +50°C
  - Storage temperature: -40 ... +80°C.
  - Relative humidity, non condensing: 90%.

#### Reference standards

Compliant with standards: IEC/EN 61869-2, IEC/EN 61869-1.

### ENERGY METERS

Mechanical meter **DME M100...**  
Digital meter **DME D100... - DME D110...**

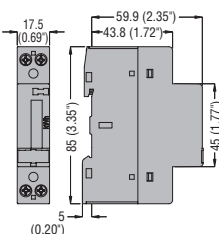

Digital meter **DME D115 T1 - DME D120 T1...**  
**DME D121 - DME D130**

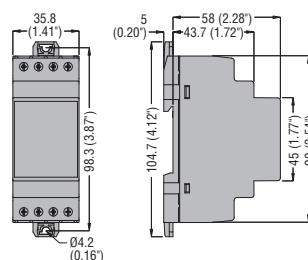

Digital meter **DME D300 T2... - DME D300 F - DME D310 F...**  
**DME D310 T2... - DME D330 - DME D301 - DME D305 T2**  
Data concentrator **DME CD - DME CD PV1...**

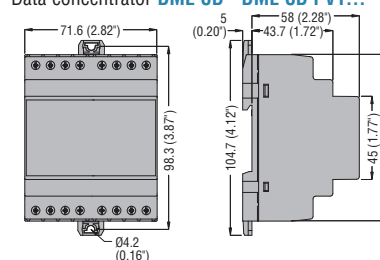

### MULTIMETERS

**DMG 100 - DMG 101 - DMG 110 - DMG 200 - DMG 210 - DMG 300**

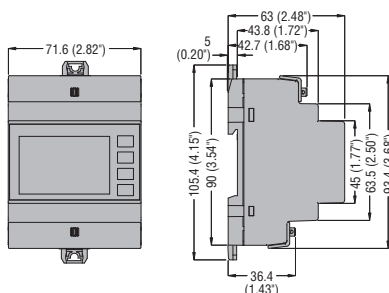

Expansion modules **EXM...**

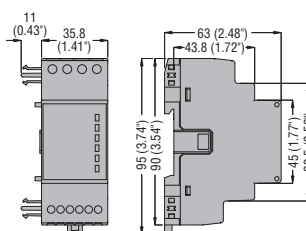

### DMG 600 - DMG 610

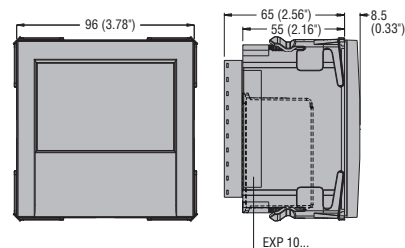

### DMG 700 - DMG 800... - DMG 900... with expansion modules EXP...

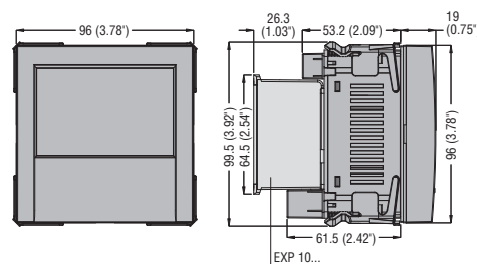

### Cutout

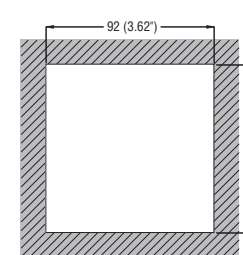

### Transducer **DMG 900T** with expansion modules **EXP...**

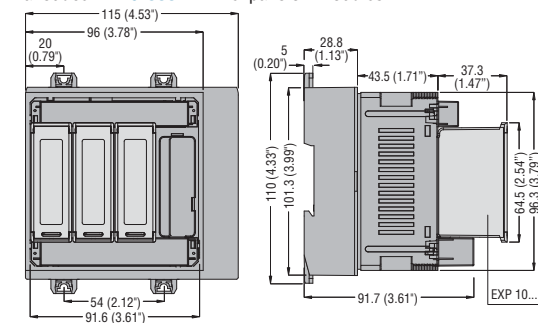

### DMG 900RD remote display

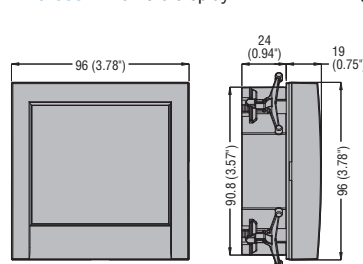

### Cutout

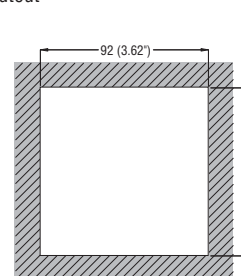

### FLUSH-MOUNT METERING INSTRUMENTS

Instruments **DMK 0... - DMK 1...**

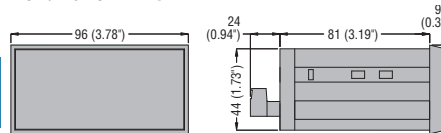

### Cutout

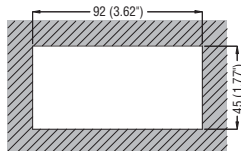

### FLUSH-MOUNT MULTIMETERS

**DMK 2...**

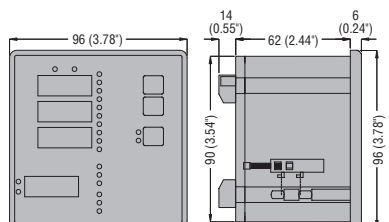

### Cutout

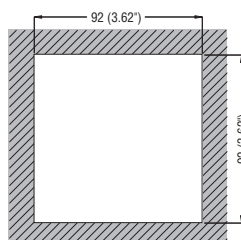

### DIGITAL METERING INSTRUMENTS

#### DMK 7... - DMK 8...

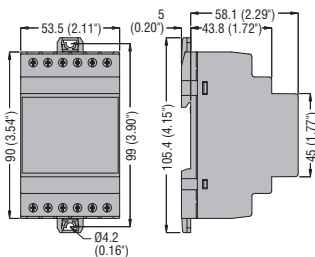

### CURRENT TRANSFORMERS

#### Solid core DM0T...

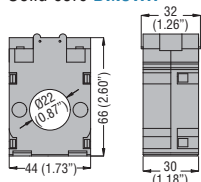

#### DM2T...

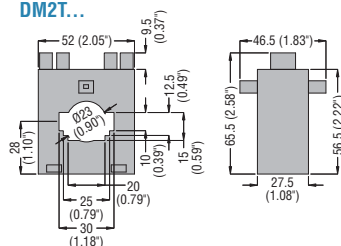

#### DM3T...

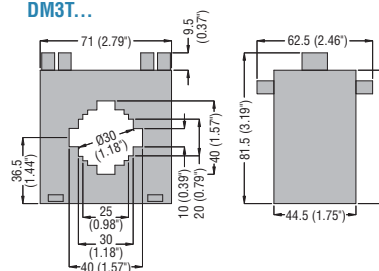

#### DM35T...

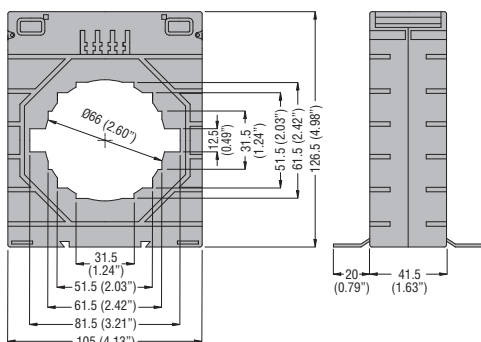

#### DM4T...

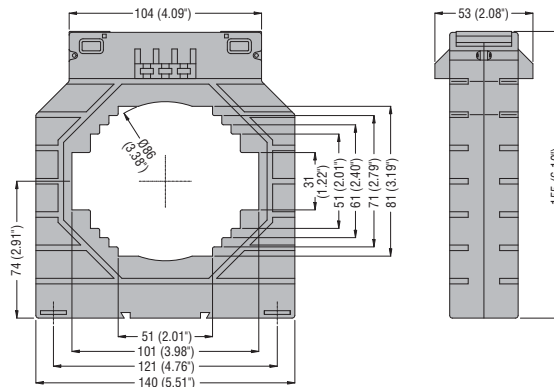

#### DM1TP0060... - DM1TP0300

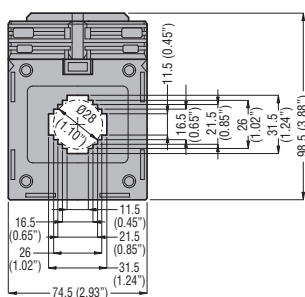

#### DM1TP0400... - DM1TP0500

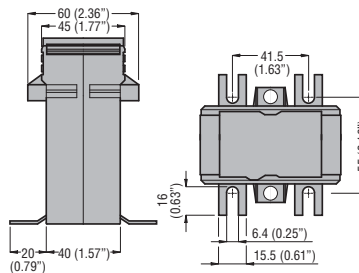
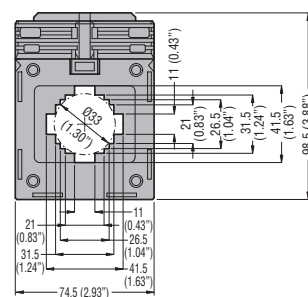

#### DM3TP...

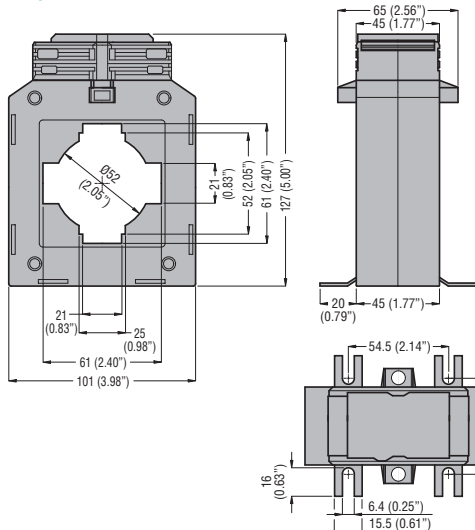

#### DM5TP...

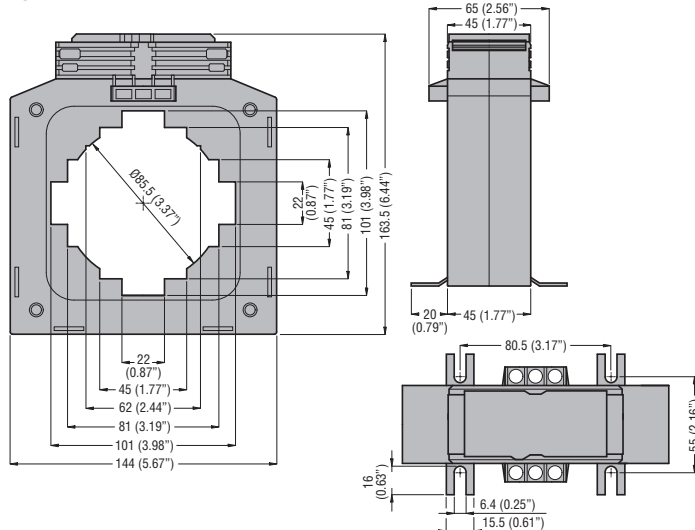

### Compact prewired split-core DM1TMA...

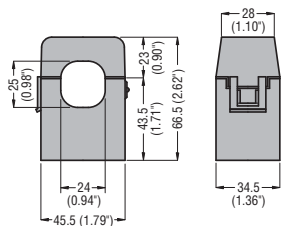

### DM2TMA...

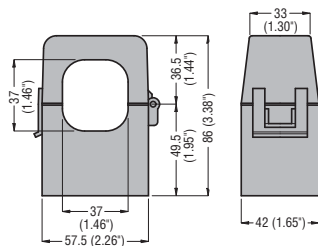

### Split-core DM1TA...

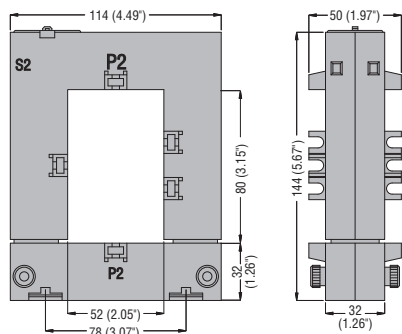

### DM2TA...

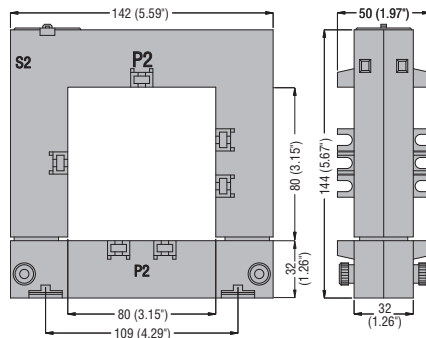

### DM3TA...

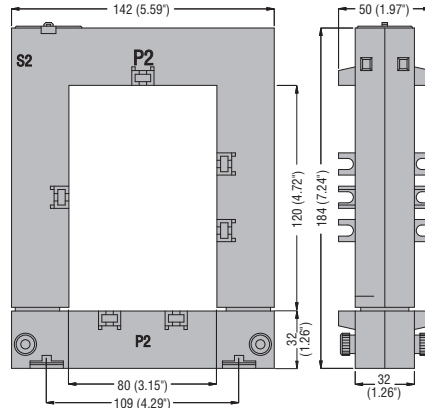

### DM4TA...

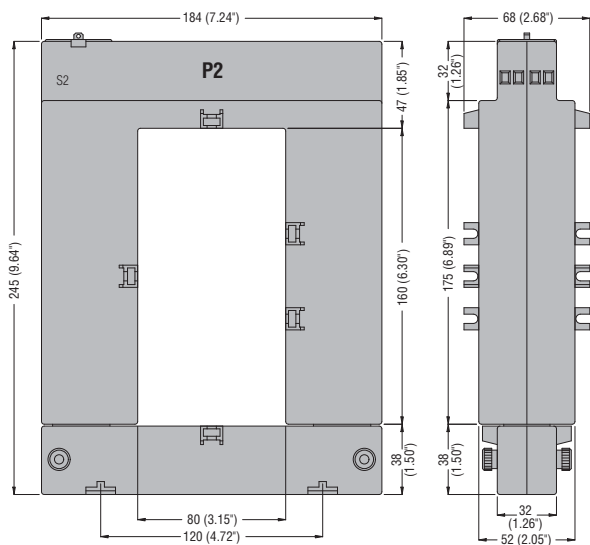

### ENERGY METERS

#### Mechanical **DME M100**

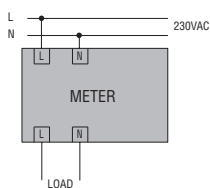

#### **DME M100 T1**

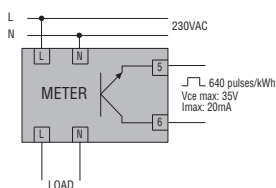

#### Digital **DME D100 T1... - DME D110 T1...**

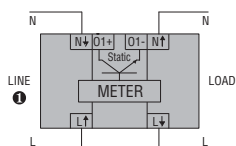

#### **DME D115 T1 - DME D120 T1... - DME D130**

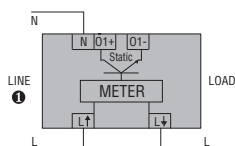

#### **DME D121**

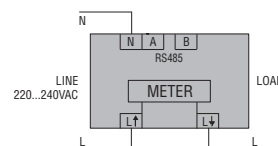

① 110-120VAC DMED...A120; 220-240VAC DMED...; 230V 50Hz DMED... T1 MID.

#### **DME D300 T2... - DME D300 F**

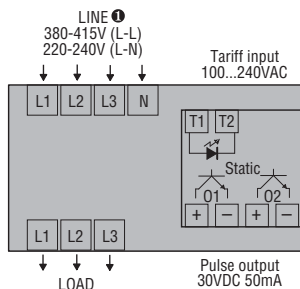

#### **DME D310 T2... - DME D310 F...**

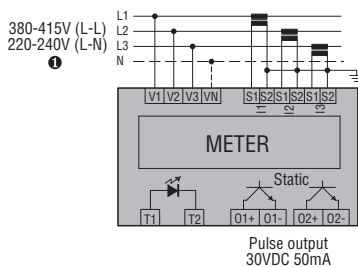

#### **DME D301**

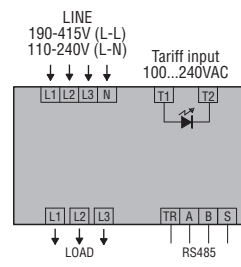

① 230V 50Hz (L-N), 400V 50Hz (L-L) DMED... T2 MID / DMED... F.

#### **DME D330 - DME D305 T2**

##### Single phase

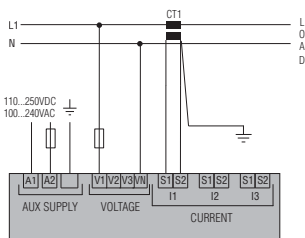

##### Two phase

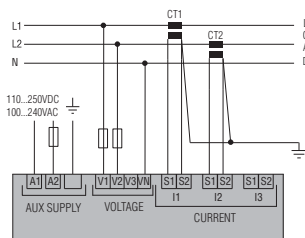

##### Three phase with or without neutral

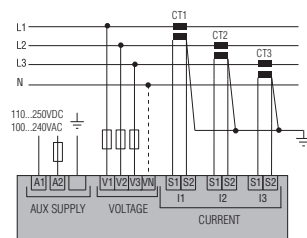

##### Three phase without neutral in ARON connection

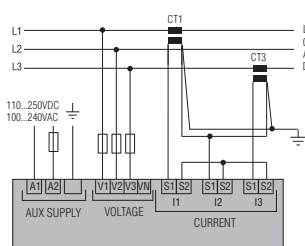
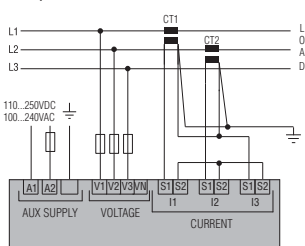

Pulse output 30VDC 50mA for DME D305 T2

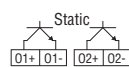

RS485 for DME D330



#### Data concentrator **DME CD - DME CD PV1**

100...240VAC  
110...250VDC

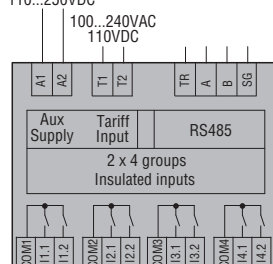

### MULTIMETERS DMG 100 - DMG 101 - DMG 110 - DMG 200 - DMG 210 - DMG 300

Single phase

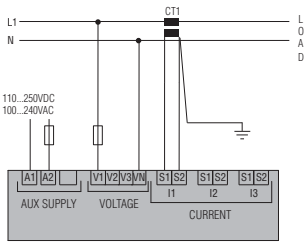

Two phase

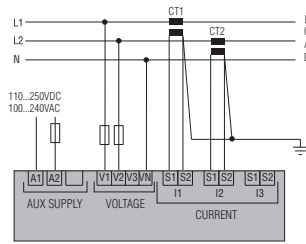

Three phase with or without neutral

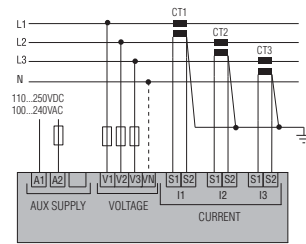

Three phase without neutral in ARON connection

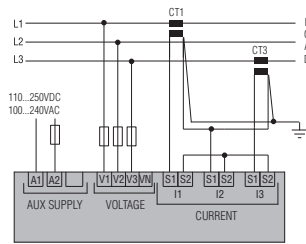
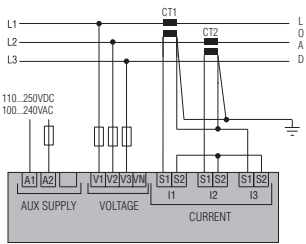

Balanced 3-phase connection with or without neutral

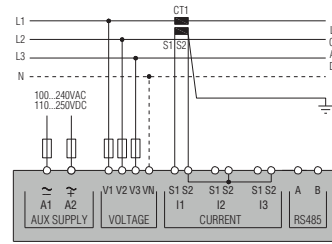

### MULTIMETERS DMG 700 - DMG 800...

Single phase

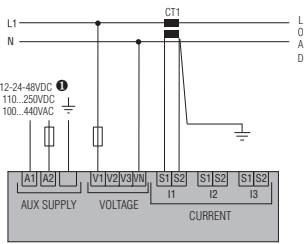

Two phase

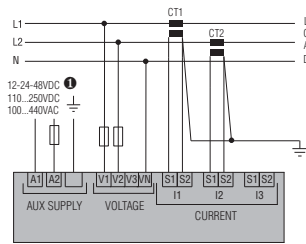

### DMG 900...

Single phase

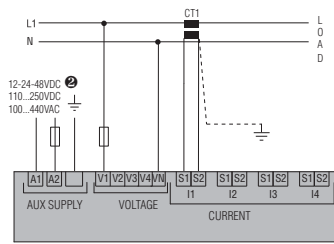

Two phase

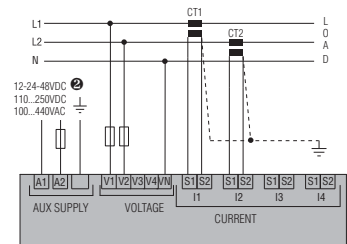

Three phase with or without neutral

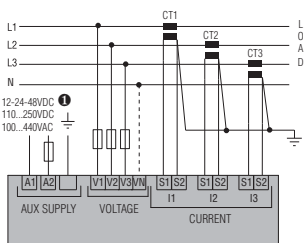

Three phase with or without neutral

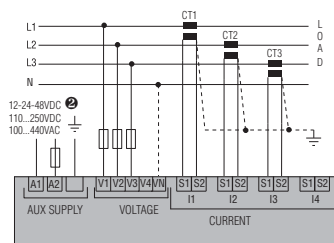

Three phase without neutral in ARON connection

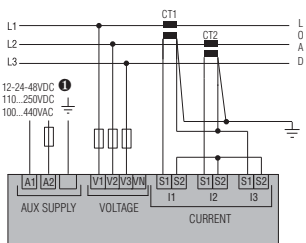

Three phase without neutral in ARON connection

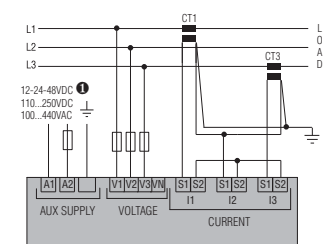
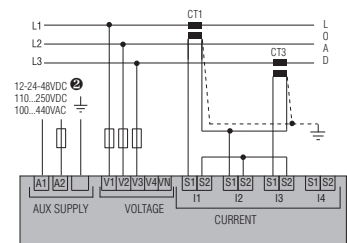
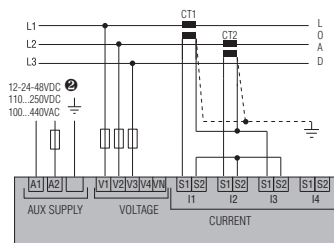

Two phase with neutral. Measurement of neutral current and neutral-earth voltage

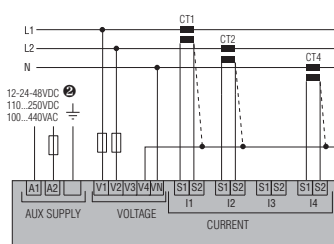

Three phase with neutral. Measurement of neutral current and neutral-earth voltage

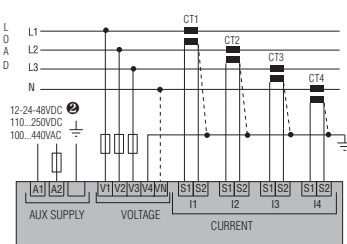

① For DMG 800... D048 only.

② For DMG 900... D048 only.

### METERING INSTRUMENTS

#### DMK 00 - DMK 00 R1

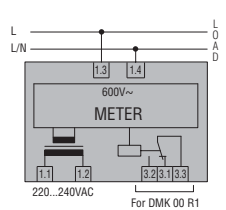

#### DMK 01 - DMK 01 R1

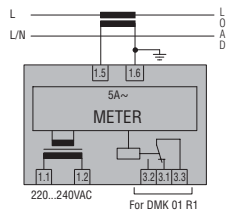

#### DMK 02

Voltmeter

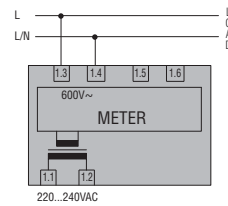

#### Ammeter

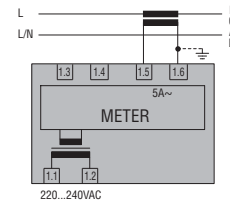

#### DMK 03 - DMK 03 R1

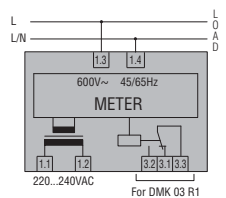

#### DMK 04 - DMK 04 R1

Single phase

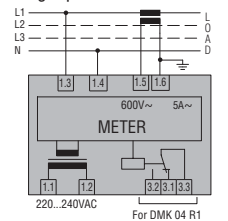

Three phase

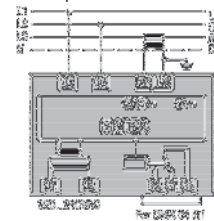

#### DMK 10 - DMK 10 R1

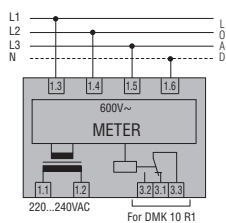

#### DMK 11 - DMK 11 R1

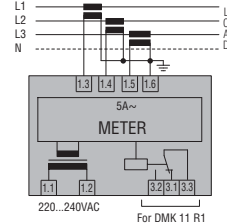

#### DMK 15 - DMK 15 R1

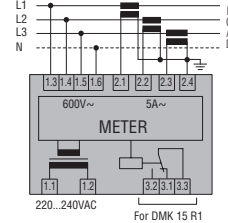

#### DMK 16 - DMK 16 R1

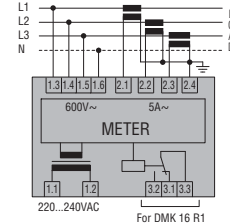

#### DMK 80 - DMK 80 R1

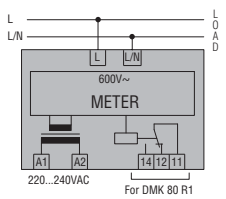

#### DMK 81 - DMK 81 R1

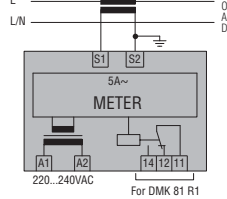

#### DMK 82

Voltmeter

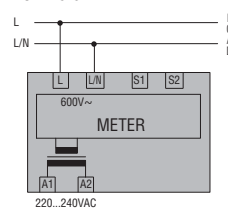

#### Ammeter

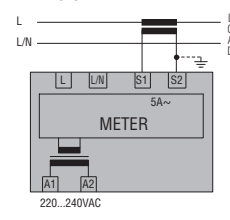

#### DMK 70 - DMK 70 R1

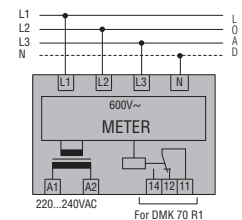

#### DMK 83 - DMK 83 R1

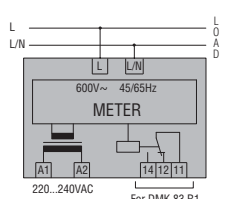

#### DMK 84 - DMK 84 R1

Single phase

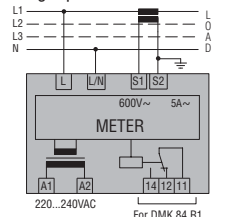

Three phase

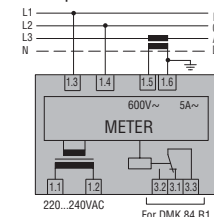

#### DMK 71 - DMK 71 R1

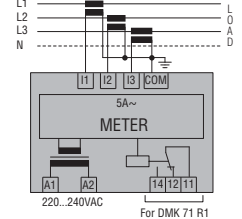

### FLUSH-MOUNT MULTIMETERS

#### DMK2...

Single phase

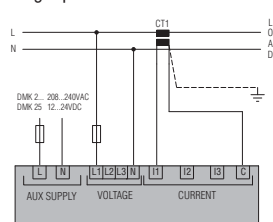

Two phase

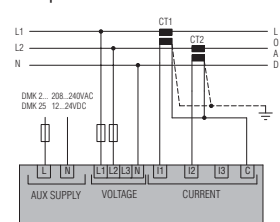

Three phase with or without neutral

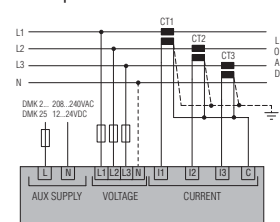

Three phase without neutral in ARON connection

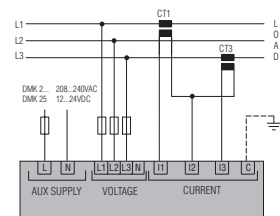
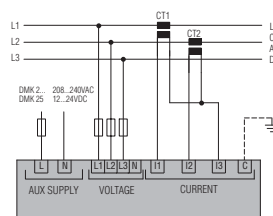

#### DMK 75 - DMK 75 R1

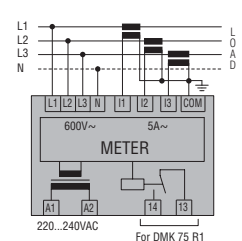



TYPE	DME M100...	DME D100 T1	DME D100 T1 A120	DME D100 T1 MID	DME D110 T1	DME D110 T1 A120
	Single phase	Single phase	Single phase	Single phase	Single phase	Single phase
<b>AUXILIARY SUPPLY</b>						
Rated voltage(Ue)	230VAC	220...240VAC	110...120VAC	230VAC	220...240VAC	110...120VAC
Operating voltage range	184...264VAC	187...264VAC	93...132VAC	187...264VAC	187...264VAC	93...132VAC
Rated frequency	50/60Hz	50/60Hz	60Hz	50Hz	50/60Hz	60Hz
Maximum power consumption	<7VA			7VA		
Maximum power dissipation	-			0,45W		
<b>CURRENT</b>						
IEC maximum current (Imax)	32A			40A		
IEC minimum current (Imin)	-			0.25A		
IEC rated current (Iref-Ib)	5A			5A		
IEC start current (Ist)	20mA			20mA		
Transition current (Itr)	-			0.5A		
<b>ACCURACY</b>						
Active energy (per IEC/EN 62053-21)	Class 1		Class 1	Class B (EN 50470-3)		Class 1
<b>OUTPUTS</b>						
LED rate	640 flash/kWh			1000 flash/kWh		
Pulse rate	640 pulses/kWh (only for DME M100 T1)			1000 pulses/kWh		
Pulse duration	-			30ms		
<b>STATIC OUTPUTS</b>						
Pulse rate	-		10 pulses/kWh		1-10-100-1000 pulses/kWh programmable	
Pulse duration	-			100ms		
External voltage	-			10...30VDC		
Maximum current	-			50mA		
<b>INSULATION</b>						
IEC rated insulation voltage Ui	-			250VAC		
IEC rated impulse withstand voltage Uimp	-			6kV		
IEC power frequency withstand voltage	-			4kV		
<b>SUPPLY/MEASUREMENT CONNECTION CIRCUIT</b>						
Type of terminals	Fixed			Fixed		
Conductor section (min...max)	2.5...6mm <sup>2</sup>			1.5...10mm <sup>2</sup> (16...6AWG)		
Maximum tightening torque	1.2Nm			1.5Nm (14lbin)		
<b>CONNECTION (PULSE OUTPUT/RS485)</b>						
Type of terminals	Fixed			Fixed		
Conductor section (min...max)	1...1.5mm <sup>2</sup> (only for DME M100 T1)			0.2...4mm <sup>2</sup> (24...12AWG)		
Maximum tightening torque	0.6Nm			0.8Nm (7lbin)		
<b>AMBIENT CONDITIONS</b>						
Operating temperature	-25...+55°C			-25...+55°C		
Storage temperature	-30...+80°C			-25...+70°C		
Relative humidity	-			<80%		
Maximum pollution degree	2			2		
Mechanical environment	-	-	-	Class M1	-	-
Magnetic environment	-	-	-	Class E1	-	-
<b>HOUSING</b>						
Material	Polyamide			Polyamide		

# Metering instruments and current transformers

## Technical characteristics

### Single-phase energy meters

DME D110 T1 MID	DME D115 T1	DME D120 T1	DME D120 T1 A120	DME D120 T1 MID	DME D121	DME D130
Single phase	Single phase	Single phase	Single phase	Single phase	Single phase /RS485	Single phase/expandable
230VAC	220...240VAC	220...240VAC	110...120VAC	230VAC	220...240VAC	220...240VAC
187...264VAC	187...264VAC	187...264VAC	93...132VAC	187...264VAC	187...264VAC	187...264VAC
50Hz	50/60Hz	50/60Hz	60Hz	50Hz	50/60Hz	50/60Hz
7VA	7VA			4.8VA		4.8VA
0.45W	0.45W			1.4W		1.4W
40A	40A	63A		63A		63A
0.25A	0.5A		0.5A		0.5A	0.5A
5A	10A		10A		10A	10A
20mA	40mA		40mA		40mA	40mA
0.5A	1A		1A		1A	1A
Class B (EN 50470-3)	Class 1			Class B (EN 50470-3)	Class 1	
1000 flash/kWh	1000 flash/kWh			1000 flash/kWh		1000 flash/kWh
1000 pulses/kWh	1000 pulses/kWh			1000 pulses/kWh		1000 pulses/kWh
30ms	30ms			30ms		30ms
1-10-100-1000 pulses/kWh programmable	1-10-100-1000 pulses/kWh programmable			-		-
100ms	100ms			-		-
10...30VDC	10...30VDC			-		-
50mA	50mA			-		-
250VAC	250VAC			250VAC		250VAC
6kV	6kV			6kV		6kV
4kV	4kV			4kV		4kV
Fixed	Fixed			Fixed		Fixed
1.5...10mm <sup>2</sup> (16...6AWG)	2.5...16mm <sup>2</sup> (14...6AWG; 14...10AWG)			2.5...16mm <sup>2</sup> (14...6AWG; 14...10AWG)		2.5...16mm <sup>2</sup> (14...6AWG; 14...10AWG)
1.5Nm (14lbin)	2Nm (26.5lbin)			2Nm (26.5lbin)		2Nm (26.5lbin)
Fixed	Fixed			Fixed		Fixed
0.2...4mm <sup>2</sup> (24...12AWG)	0.5...4mm <sup>2</sup> (20...11AWG)			0.5...4mm <sup>2</sup> (20...11AWG)		0.5...4mm <sup>2</sup> (20...11AWG)
0.8Nm (7lbin)	1.3Nm (12.1lbin)			1.3Nm (12.1lbin)		1.3Nm (12.1lbin)
-25...+55°C	-25...+55°C			-25...+55°C		-25...+55°C
-25...+70°C	-25...+70°C			-25...+70°C		-25...+70°C
<80%	<80%			<80%		<80%
2	2			2		2
Class M1	-	-	-	Class M1	-	-
Class E1	-	-	-	Class E1	-	-
Polyamide	Polyamide			Polyamide		Polyamide

TYPE	DME D300 T2 DME D301	DME D300 T2 MID / F	DME D310 T2 DME D305 T2	DME D310 T2 MID / F	DME D330
	3 phase with neutral	3 phase with neutral	3 phase c/w and w/o neutral	3 phase c/w and w/o neutral	3 phase c/w and w/o neutral
<b>AUXILIARY SUPPLY</b>					
Rated voltage (Ue)	220...240VAC phase-neutral 380...415VAC phase-phase for DME D300T2 110...240VAC phase-neutral 190...415VAC phase-phase for DME D301	230VAC phase-neutral 400VAC phase-phase	220...240VAC phase-neutral 380...415VAC phase-phase	230VAC phase-neutral 400VAC phase-phase	100...240VAC 110...250VDC
Voltage range	187...264VAC phase-neutral / 323...456VAC phase-phase 94...264VAC phase-neutral / 162...456VAC phase-phase (for DME D301)				85...264VAC 93.5...300VDC
Rated frequency	50/60Hz	50Hz	50/60Hz	50Hz	45...66Hz
Maximum power consumption	20VA		2.1VA		4.5VA
Maximum power dissipation	1.35W		0.8W		1.7W
<b>CURRENT</b>					
IEC maximum current (Imax)	63A - 80A for DME D301		5A		5A
IEC minimum current (Imin)	0.5A		0.05A		0.01A
IEC rated current (Iref-Ib)	10A		5A		—
IEC start current (Ist)	40mA		0,01A		—
IEC transition current (Itr)	1A		0.25A		—
<b>ACCURACY</b>					
Active energy (per IEC/EN 62053-21)	Class 1	Class B (EN50470-3)	Class 1	Class B (EN50470-3)	Class 0.5s
<b>TARIFF CIRCUIT INPUT</b>					
Rated voltage (Uc)	100...240VAC				
Voltage range	85...264VAC				
Frequency	50/60Hz				
Maximum power consumption	0.25VA				
Maximum power dissipation	0.18W				
<b>LED</b>					
Pulse rate	1000 pulses/kWh				
Pulse duration	30ms				
<b>STATIC OUTPUTS</b>					
Pulse rate	1-10-100-1000 pulses/kWh programmable (except DME D301)		0.1-1-10-100 pulses/kWh programmable		—
Pulse duration	100ms for 1-10-100 pulses (except DME D301) 60ms for 1000 pulses (except DME D301)		100ms		—
External voltage	10...30VDC (except DME D301)		10...30VDC		—
Maximum current	50mA (except DME D301)				—
<b>INSULATION</b>					
IEC rated insulation voltage Ui	250VAC		250VAC		690VAC
IEC rated impulse withstand voltage Uimp	6kV		6kV		9.5kV
IEC power frequency withstand voltage	4kV		4kV		5.2kV
<b>SUPPLY/MEASUREMENT CIRCUIT CONNECTIONS</b>					
Type of terminals	Fixed		Fixed		
Conductor section (min...max)	2.5...16mm <sup>2</sup> (16...6AWG)		0.2...4mm <sup>2</sup> (24...12AWG) for supply/voltage measurement; 0.2...2.5mm <sup>2</sup> (24...12AWG) for current measurement		
Maximum tightening torque	2Nm (14lbin)		0.8Nm (7lbin)		
<b>TARIFF CONTROL CIRCUIT CONNECTIONS</b>					
Type of terminals	Fixed		Fixed		
Conductor section (min...max)	0.2...2.5mm <sup>2</sup> (24...12AWG)		0.2...4mm <sup>2</sup> (24...12AWG)		
Maximum tightening torque	0.49Nm (4.4lbin)		0.8Nm (7lbin) (0.44Nm / 4lbin for current measurement DME D320)		
<b>CONNECTIONS (PULSE OUTPUT/RS485)</b>					
Type of terminals	Fixed		Fixed		
Conductor section (min...max)	0.2...1.3mm <sup>2</sup> (24...16AWG)		0.2...2.5mm <sup>2</sup> (24...12AWG)		
Maximum tightening torque	0.15Nm (1.7lbin)		0.44Nm (4lbin)		
<b>AMBIENT CONDITIONS</b>					
Operating temperature	-25...+55°C		-25...+55°C		-20...+60°C
Storage temperature	-25...+70°C		-25...+70°C		-30...+80°C
Relative humidity	<80% non condensing		<80% non condensing		<90%
Maximum pollution degree	2		2		2
Mechanical environment	—	Class M1	—	Class M1	—
Magnetic environment	—	Class E1	—	Class E1	—
<b>HOUSING</b>					
Material	Polyamide			Polyamide	

TYPE	DME CD	DME CD PV1
<b>AUXILIARY SUPPLY</b>		
Rated voltage (Us)	100...240VAC/110...250VDC	
Voltage range	85...264VAC/93.5...300VDC	
Rated frequency	50/60Hz	
Maximum power consumption	8.8VA	
Maximum power dissipation	3.6W	
<b>ENERGY METER INPUTS</b>		
Number of inputs	8	
Input separation	1 common for every 2 inputs (insulated between each pair 500VRMS)	
Type of input	Negative (NPN)	
Maximum voltage at inputs	15VDC	
Maximum input current	18mA (15mA typical)	
High input signal	≥7.6V	
Low input signal	≤2V	
Maximum frequency	2000Hz	
<b>TARIFF CONTROL CIRCUIT</b>		
Rated voltage (Uc)	100...240VAC/110VDC	
Voltage range	85...264VAC/93.5...140VDC	
Frequency	50/60Hz	
Maximum power consumption	0.25VA	
Maximum power dissipation	0.18W	
<b>RS485 SERIAL INTERFACE</b>		
Baud-rate	Programmable 1200-38400bps	
Insulation	1500VAC towards energy meter inputs. Double insulation towards supply and tariff inputs	
<b>INSULATION</b>		
IEC rated insulation voltage Ui	250VAC	
IEC rated impulse withstand voltage Uimp	6.5kV	
IEC power frequency withstand voltage	3.6kV	
<b>SUPPLY CIRCUIT CONNECTIONS</b>		
Type of terminals	Fixed	
Conductor section (min...max)	0.2...4mm <sup>2</sup> (24...12AWG)	
Maximum tightening torque	0.8Nm (7lbin)	
<b>TARIFF INPUT CIRCUIT CONNECTIONS</b>		
Type of terminals	Fixed	
Conductor section (min...max)	0.2...4mm <sup>2</sup> (24...12AWG)	
Maximum tightening torque	0.8Nm (7lbin)	
<b>RS485 CONNECTION</b>		
Type of terminals	Fixed	
Conductor section (min...max)	0.2...4mm <sup>2</sup> (24...12AWG)	
Maximum tightening torque	0.8Nm (7lbin)	
<b>ENERGY METER INPUT CONNECTIONS</b>		
Type of terminals	Fixed	
Conductor section (min...max)	0.2...2.5mm <sup>2</sup> (24...12AWG)	
Maximum tightening torque	0.44Nm (4lbin)	
<b>AMBIENT CONDITIONS</b>		
Operating temperature	-20...+60°C	
Storage temperature	-30...+80°C	
Relative humidity	<90%	
Maximum pollution degree	2	
<b>HOUSING</b>		
Material	Polyamide	

TYPE	DMG 100 - DMG 101 - DMG 110 <sup>①</sup>	DMG 200	DMG 210	DMG 300
<b>AUXILIARY SUPPLY</b>				
Rated voltage $U_s$	100...240VAC/ 110...250VDC			
Voltage range	85...264VAC/ 93.5...300VDC			
Frequency range	45...66Hz			
Maximum power consumption	3.5VA	3.5VA	4.5VA	3.2VA
Maximum power dissipation	1.2W	1.2W	1.7W	1.3W
Microbreaking immunity	≥50ms	≥50ms	≥50ms	≥50ms
<b>VOLTAGE INPUTS</b>				
Type of input	Three phase + neutral			
Maximum rated voltage $U_e$	690VAC phase-phase (400VAC phase-neutral)			
Measurement range	20...830VAC phase-phase (10...480VAC phase-neutral)			
Frequency range	45...66Hz			
Method of measurement	True RMS			
Method of connection	Single, two, three phase with or without neutral, balanced three phase systems			
<b>CURRENT INPUTS</b>				
Rated current $I_e$	5A	5A	5A	1A/5A
Measurement range	0.01...6A	0.01...6A	0.01...6A	0.01...1.2A / 0.01...6A
Method of measurement	True RMS			
Overload capacity	+20% $I_e$ through external CT with 5A secondary			
Overload peak	50A for 1s			
<b>INSULATION</b>				
IEC rated insulation voltage $U_i$	690VAC			
IEC rated impulse withstand voltage $U_{imp}$	9.5kV			
IEC power frequency withstand voltage	5.2kV			
<b>SUPPLY CIRCUIT/VOLTAGE MEASUREMENT CONNECTIONS</b>				
Type of terminal	Fixed			
Conductor section (min...max)	0.2...4.0mm <sup>2</sup> (24...12 AWG)			
Maximum tightening torque	0.8Nm (7lbin)			
<b>CURRENT MEASUREMENT CIRCUIT AND RS485<sup>①</sup> CONNECTIONS AND DIGITAL INPUTS/OUTPUTS<sup>②</sup></b>				
Type of terminal	Fixed			
Conductor section (min...max)	0.2...2.5mm <sup>2</sup> (24...12AWG)			
Maximum tightening torque	0.44Nm (4lbin)			
<b>AMBIENT CONDITIONS</b>				
Operating temperature	-20...+60°C			
Storage temperature	-30...+80°C			
Relative humidity	<90%			
Maximum pollution degree	2			
Measurement class	III			
<b>HOUSING</b>				
Material	Polyamide			

① RS485 communication port for DMG 110, DMG 210, DMG 610 and DMG 900T only.

② For DMG 800 D048, DMG 900 D048 and DMG 900T D048 only.

③ For DMG 101 only.



	DMG 600	DMG 610	DMG 700	DMG 800	DMG 900	DMG 900 T
	100...440VAC 120...250VDC			100...440VAC 110...250VDC - (12...48VDC $\oplus$ )		
	90...484VAC 93.5...300VDC			90...484VAC 93.5...300VDC - (9...70VDC $\oplus$ )		
	45...65Hz			45...66Hz		
	9.5VA			3.9VA		
	3.5W			3.4W		
	≥50ms			≥50ms		
	Three phase + neutral 600VAC phase-phase (300VAC phase-neutral)			Three phase + neutral 690VAC phase-phase (400VAC phase-neutral)		
	50...720VAC phase-phase (30...360VAC phase-neutral)			20...830VAC phase-phase (10...480VAC phase-neutral)		
	45...66Hz		45...66Hz	45...66Hz and 360...440Hz		
	True RMS			True RMS		
	Single, two, three phase with or without neutral, balanced three phase systems					
	1A/5A 0.01...1.2A / 0.01...6A True RMS	5A 0.01...6A		1A/5A 0.01...1.2A / 0.01...6A True RMS	1A/5A 0.002...1.2A / 0.01...10A	
	+20% Ie by external CT with 5A secondary 50A for 1s					
	600VAC			690VAC		
	9.5kV			9.5kV		
	5.2kV			5.2kV		
				Removable 0.2...2.5mm <sup>2</sup> (24...12AWG) 0.5Nm (4.5lbin)		
	Fixed 0.2...1.5mm <sup>2</sup> (24...12 AWG) 0.8Nm (7lbin)			Fixed 0.5...4mm <sup>2</sup> (26...10 AWG); 0.2...1.5mm <sup>2</sup> (24...12 AWG) for RS485 0.8Nm (7lbin)		
				-20...+60°C		
				-30...+80°C		
				<90%		
				2		
				III		
				Polyamide		

TYPE	DMK 00 - DMK 00 R1 DMK 80 - DMK 80 R1	DMK 01 - DMK 01 R1 DMK 81 - DMK 81 R1	
<b>AUXILIARY SUPPLY</b>			
Rated voltage $U_s$	24VAC❶ 110...127VAC❶ 220...240VAC 380...415VAC❶		
Operating voltage range	0.85...1,1 $U_s$		
Rated frequency	50...60Hz $\pm 10\%$		
Maximum power consumption	3.3VA (DMK...) 3.6VA (DMK... R1)		
Maximum power dissipation	1.5W (DMK...) 1.8W (DMK... R1)		
<b>VOLTAGE INPUTS</b>			
Rated voltage $U_e$	600VAC	—	
Operating voltage range	15...660VAC	—	
Operating voltage range, phase-phase	—	—	
Rated frequency	50...60Hz $\pm 10\%$	—	
Method of measuring	TRMS	—	
<b>CURRENT INPUTS</b>			
Rated current $I_e$	—	5A	
Measuring range	—	0.05...5.75A	
Rated frequency	—	50...60Hz $\pm 10\%$	
Type of input	—	Shunts connected by external low voltage CT 5A max	
Type of measuring	—	TRMS	
Overload capacity	—	+20% $I_e$	
<b>FREQUENCY INPUTS</b>			
Measuring range and type	—	—	
Voltage range	—	—	
Input rated voltage	—	—	
<b>MEASURING ACCURACY</b>			
Measurement conditions (Temperature +23°C $\pm 1^\circ\text{C}$ ) (Relative humidity 45 $\pm 15\%$ R.H.)	cos $\varphi$	—	—
	voltage	$\pm 0.25\%$ f.s. $\pm 1$ digit	—
	current	—	$\pm 0.5\%$ f.s. $\pm 1$ digit
	frequency	—	—
<b>ADDITIONAL ERRORS</b>			
Relative humidity	$\pm 1$ digit 60%...90% R.H..		
Temperature	$\pm 1$ digit -20...+60°C		
<b>RELAY OUTPUT FOR DMK... R1 TYPES ONLY</b>			
Number and type of contact	1 changeover		
Rated voltage	250VAC		
IEC/EN 60947-5-1 designation	AC1 8A 250VAC / B300		
Electrical life	$10^5$		
Mechanical life	$30 \times 10^6$		
<b>INSULATION</b>			
Rated insulation voltage $U_i$	600VAC	415VAC	
<b>CONNECTIONS</b>			
Type of terminals	Fixed (DMK 8...); Removable (DMK 0...)		
Maximum tightening torque	0.8Nm (7lbin) for DMK 0... / 0.5Nm (4.5lbin) for DMK 8...		
Conductor section (min...max)	0.2...2.5mm <sup>2</sup> (24...12AWG) for DMK 0... 0.2...4.0mm <sup>2</sup> (24...12AWG) for DMK 8...		
<b>AMBIENT CONDITIONS</b>			
Operating temperature	-20...+60°C		
Storage temperature	-30...+80°C		
<b>HOUSING</b>			
Material	Thermoplastic (DMK 0...) / Polyamide (DMK 8...)		

❶ On specific request.

DMK 02 DMK 82	DMK 03 - DMK 03 R1 DMK 83 - DMK 83 R1	DMK 04 - DMK 04 R1 DMK 84 - DMK 84 R1
	24VAC❶ 110...127VAC❶ 220...240VAC 380...415VAC❶	
	0.85...1.1 Us	
	50...60Hz ±10%	
3.3VA 3.6VA (DMK... R1)		3.3VA (DMK...)
1.5W 1.8W (DMK... R1)		1.5W (DMK...)
600VAC	—	600VAC
15...660VAC	—	—
—	—	15...660VAC (DMK...)
50...60Hz ±10%	25...660VAC (DMK... R1)	50...60Hz ±10%
TRMS	—	TRMS
5A	—	5A
0.05...5.75A	—	0.05...5.75A (DMK...) 0.1...5.75A (DMK... R1)
50...60Hz ±10%	—	50...60Hz ±10%
Shunts connected by external low voltage CT 5A max	—	Shunts connected by external low voltage CT 5A max
TRMS	—	TRMS
+20% Ie	—	+20% Ie
—	15...65Hz ±10% TRMS	—
—	15...660VAC	—
—	600VAC	—
—	—	± 1° ±1 digit
±0.25% f.s. ±1 digit	—	—
±0.5% f.s. ±1 digit	—	—
—	±1 digit	—
	±1 digit 60%...90% R.H..	
	±1 digit -20...+60°C	
	1 changeover	
	250VAC	
	AC1 8A 250VAC / B300	
	10 <sup>5</sup>	
	30x10 <sup>6</sup>	
	600VAC	
	Fixed (DMK 8...); Removable (DMK 0...)	
	0.8Nm (7lbin) for DMK 0... / 0.5Nm (4.5lbin) for DMK 8...	
	0.2...2.5mm <sup>2</sup> (24...12AWG) for DMK 0... 0.2...4.0mm <sup>2</sup> (24...12AWG) for DMK 8...	
	-20...+60°C	
	-30...+80°C	
	Thermoplastic (DMK 0...) / Polyamide (DMK 8...)	

❶ On specific request

TYPE	DMK 10 - DMK 10 R1 DMK 70 - DMK 70 R1	DMK 11 - DMK 11 R1 DMK 71 - DMK 71 R1	DMK 15 - DMK 15 R1 DMK 75 - DMK 75 R1	DMK 16 DMK 16 R1	
<b>AUXILIARY SUPPLY</b>					
Rated supply voltage $U_s$	24VAC❶ 110...127VAC❶ 220...240VAC 380...415VAC❶				
Operating voltage range	0.85...1.1 $U_s$				
Frequency	50...60Hz $\pm 10\%$				
Maximum power consumption	3.3VA (DMK...) 3.6VA (DMK... R1)	3.3VA (DMK...) 3.6VA (DMK... R1)	3.3VA (DMK...) 3.6VA (DMK... R1)	3.6VA (DMK...) 3.9VA (DMK... R1)	
Maximum power dissipation	1.5W (DMK...) 1.8W (DMK... R1)	1.5W (DMK...) 1.8W (DMK... R1)	1.5W (DMK...) 1.8W (DMK... R1)	1.8W (DMK...) 2.1W (DMK... R1)	
<b>VOLTAGE INPUTS</b>					
Rated voltage $U_e$	phase-phase	600VAC	—	600VAC	
	phase-neutral	347VAC	—	347VAC	
Operating voltage range	phase-phase	15...660VAC	—	35...660VAC	
	phase-neutral	10...382VAC	—	20...382VAC	
Frequency range	50...60Hz $\pm 10\%$	—	50...60Hz $\pm 10\%$	50...60Hz $\pm 10\%$	
Method of measuring	TRMS	—	TRMS	TRMS	
<b>CURRENT INPUTS</b>					
Rated current $I_e$	—	5A	5A	5A	
Measuring range	—	0.05...6A	0.05...5.75A	0.05...5.75A	
Frequency range	—	50...60Hz $\pm 10\%$	50...60Hz $\pm 10\%$	50...60Hz $\pm 10\%$	
Type of input	—	Shunts connected by external low voltage CT 5A max			
Type of measuring	—	TRMS	TRMS	TRMS	
Overload capacity	—	+20% $I_e$	+20% $I_e$	+20% $I_e$	
<b>MEASURING ACCURACY</b>					
Measurement conditions (Temperature +23°C $\pm 1^\circ\text{C}$ (Humidity 45 $\pm 15\%$ R.H.))	voltage	$\pm 0.25\%$ f.s. $\pm 1$ digit	—	$\pm 0.25\%$ f.s. $\pm 1$ digit	
	current	—	$\pm 0.5\%$ f.s. $\pm 1$ digit	$\pm 0.5\%$ f.s. $\pm 1$ digit	
	power	—	—	1% f.s. $\pm 1$ digit	
	energy	—	—	—	Class 2
	frequency	—	—	$\pm 1$ digit	$\pm 1$ digit
<b>RELAY OUTPUT FOR DMK... R1 TYPES ONLY</b>					
Number and type of contact	1 changeover	1 changeover	1 changeover❷	1 changeover	
Rated voltage	250VAC	250VAC	250VAC	250VAC	
IEC/EN 60947-5-1 designation	AC1 8A 250VAC / B300	AC1 8A 250VAC / B300	AC1 8A 250VAC / B300	AC1 8A 250VAC / B300	
Electrical life	$10^5$	$10^5$	$10^5$	$10^5$	
Mechanical life	$30 \times 10^6$	$30 \times 10^6$	$30 \times 10^6$	$30 \times 10^6$	
<b>INSULATION</b>					
Rated insulation voltage $U_i$	600VAC	415VAC	600VAC	600VAC	
<b>CONNECTIONS</b>					
Type of terminals	Removable (DMK 1...); fixed (DMK 7...)				
Maximum tightening torque	0.5Nm (4.5lbin) for DMK 1...; 0.8Nm (7lbin) for DMK 7...				
Conductor section (min...max)	0.2...2.5mm <sup>2</sup> (24...12AWG) for DMK 0... 0.2...4.0mm <sup>2</sup> (24...12AWG) for DMK 7...				
<b>AMBIENT CONDITIONS</b>					
Operating temperature	-20...+60°C	-20...+60°C	-20...+60°C	-20...+60°C	
Storage temperature	-30...+80°C	-30...+80°C	-30...+80°C	-30...+80°C	
<b>HOUSING</b>					
Material	Thermoplastic (DMK 1...) / Polyamide (DMK 7...)				

❶ On specific request.

❷ One contact NO for DMK 75 R1.

TYPE	DMK 20 - DMK 21 - DMK 22	
AUXILIARY SUPPLY		
Rated supply voltage $U_s$	208...240VAC	
Operating voltage range	154...288VAC for DMK 20 177...264VAC for DMK 21 - DMK 22	
Frequency	45...65Hz	
Maximum power consumption	5.5VA ( $U_s=240V$ ) for DMK 20 - DMK 21 6VA ( $U_s=240V$ ) for DMK 22	
Maximum power dissipation	2.5W ( $U_s=240V$ ) for DMK 20 - DMK 21 2.8W ( $U_s=240V$ ) for DMK 22	
Immunity time of microbreakings	20ms	
VOLTAGE INPUTS		
Maximum rated voltage ( $U_e$ )	690VAC phase-phase (400VAC phase-neutral)	
Operating voltage range	60...830V phase-phase (30...480VAC phase-neutral)	
Frequency range	45...65Hz	
Method of measuring	True RMS	
Measuring input impedance	>1.1M $\Omega$ phase-phase and >570k $\Omega$ phase-neutral	
Method of connections	Single phase, two-phase, three-phase, or balanced three-phase system	
Measuring error	$\pm 0.25\%$ full scale $\pm 1$ digit (Class 0.5)	
CURRENT INPUTS		
Rated current $I_e$	5A (1A on request)	
Measuring range	0.05...6A	
Method of measuring	True RMS	
Overload capacity	+20% $I_e$ by external CT with 5A secondary	
Overload peak	50A for 1s	
Dynamic peak	125A for 10ms	
Power consumption	<0.6W per phase	
Measuring error	Class 0.5 $\pm 0.25\%$ f.s. $\pm 1$ digit	
MEASURING ACCURACY		
Measurement conditions (Temperature $+23^\circ\text{C} \pm 1^\circ\text{C}$ Humidity $45 \pm 15\%$ R.H.)	voltage	Class 0.5 $\pm 0.35\%$ f.s. (830V)
	current	Class 0.5 $\pm 0.5\%$ f.s. (6A)
	active energy	Class 2
	frequency	—
	harmonic distortion	—
OUTPUTS		
Relay (1 changeover contact)	—	
Static (with 1 two-way MOSFET output)	—	
INSULATION		
IEC rated insulation voltage $U_i$	690V	
CONNECTIONS		
Type of terminals	Removable	
Maximum tightening torque	0.5Nm (4.5lbin)	
Conductor section (min...max)	0.2...2.5mm <sup>2</sup> (24...12AWG)	
AMBIENT CONDITIONS		
Operating temperature	-20...+60°C	
Storage temperature	-30...+80°C	
Relative humidity	<90%	
Maximum pollution degree	2	
HOUSING		
Material	Self-extinguishing black plastic	

① For DMK 32D 048 only.