

8mm Round With Flange Type  
Yellow LED  
Technical Data Sheet

Part No.: LL-803YD2C-2Y

## Features:

- ◇ 8 mm Round.
- ◇ Choice of various color.
- ◇ Available on tape and reel.
- ◇ Reliable and robust.
- ◇ The product itself will remain within RoHS compliant Version.

## Descriptions:

- ◇ The series is specially designed for applications requiring higher brightness.
- ◇ The LED lamps are available with different colors, intensities.

## Applications:

- ◇ Message boards.
- ◇ Full color/video signs.
- ◇ Variable message signs(VMS).
- ◇ Backlighting.
- ◇ Commercial outdoor advertising, etc.

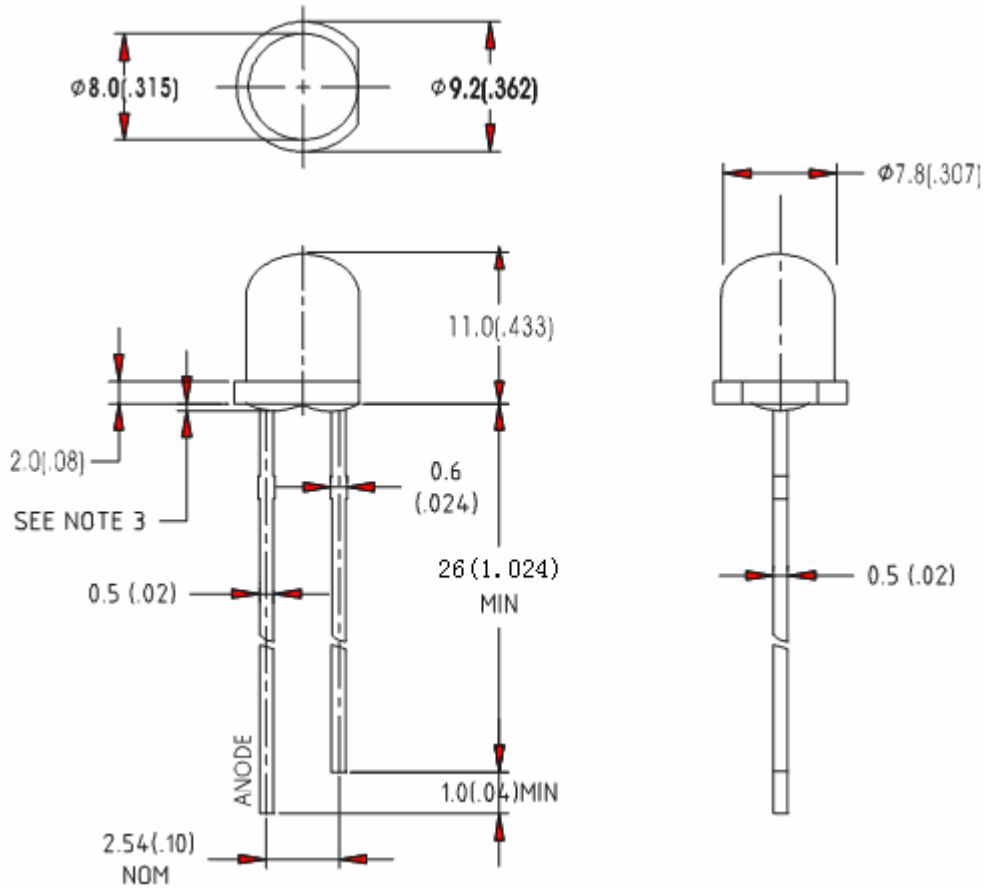
**Package Dimension:**

| Part No.      | Chip Material | Lens Color      | Source Color |
|---------------|---------------|-----------------|--------------|
| LL-803YD2C-2Y | GaP           | Yellow Diffused | Yellow       |

**Notes:**

1. All dimensions are in millimeters (inches).
2. Tolerance is  $\pm 0.25$  mm (.010") unless otherwise noted.
3. Protruded resin under flange is 1.00 mm (.04") max.
4. Specifications are subject to change without notice.

**Absolute Maximum Ratings at Ta=25°C**

| Parameters   | Symbol | Max.                | Unit |
|--|--------|---------------------|------|
| Power Dissipation  | PD     | 78                  | mW   |
| Peak Forward Current<br>(1/10 Duty Cycle, 0.1ms Pulse Width) | IFP    | 100                 | mA   |
| Forward Current  | IF     | 30                  | mA   |
| Reverse Voltage  | VR     | 5                   | V    |
| Operating Temperature Range                                  | Topr   | -40°C to +80°C      |      |
| Storage Temperature Range                                    | Tstg   | -40°C to +85°C      |      |
| Lead Soldering Temperature<br>[4mm (.157") From Body]        | Tsld   | 260°C for 5 Seconds |      |

**Electrical Optical Characteristics at Ta=25°C**

| Parameters               | Symbol          | Min. | Typ. | Max. | Unit    | Test Condition   |
|--------------------------|-----------------|------|------|------|---------|------------------|
| Luminous Intensity *     | IV              | 3    | 13   | ---  | mcd     | IF=10mA (Note 1) |
| Viewing Angle *          | $2\theta_{1/2}$ | ---  | 40   | ---  | Deg     | IF=20mA (Note 2) |
| Peak Emission Wavelength | $\lambda_p$     | ---  | 592  | ---  | nm      | IF=20mA          |
| Dominant Wavelength      | $\lambda_d$     | ---  | 589  | ---  | nm      | IF=20mA (Note 3) |
| Spectral Line Half-Width | $\Delta\lambda$ | ---  | 35   | ---  | nm      | IF=20mA          |
| Forward Voltage          | VF              | 1.80 | 2.20 | 2.60 | V       | IF=20mA          |
| Reverse Current          | IR              | ---  | ---  | 10   | $\mu$ A | VR=5V            |

**Notes:**

- Luminous Intensity Measurement allowance is  $\pm 10\%$ .
- $\theta_{1/2}$  is the off-axis angle at which the luminous intensity is half the axial luminous intensity.
- The dominant wavelength ( $\lambda_d$ ) is derived from the CIE chromaticity diagram and represents the single wavelength which defines the color of the device.

Typical Electrical / Optical Characteristics Curves  
(25°C Ambient Temperature Unless Otherwise Noted)

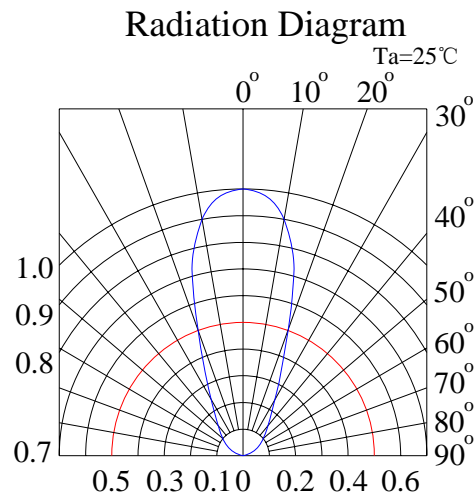
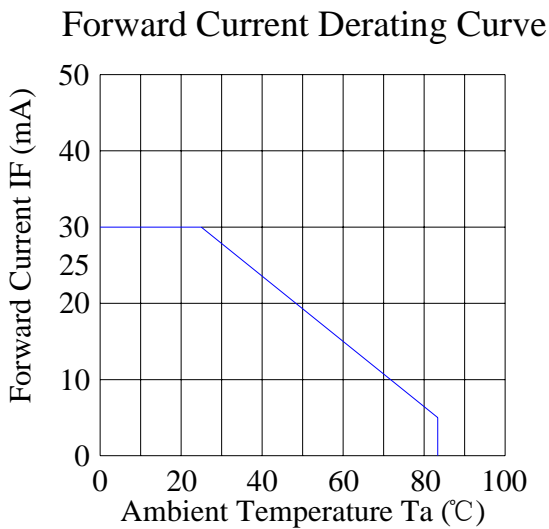
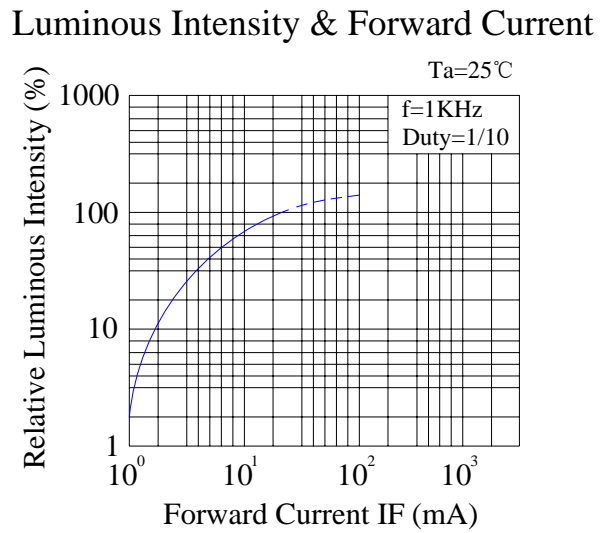
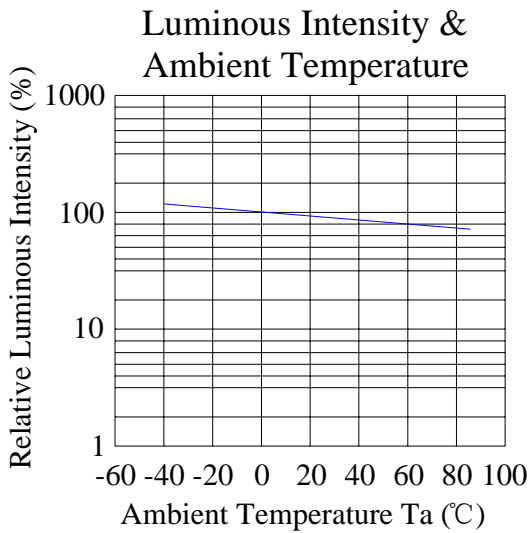
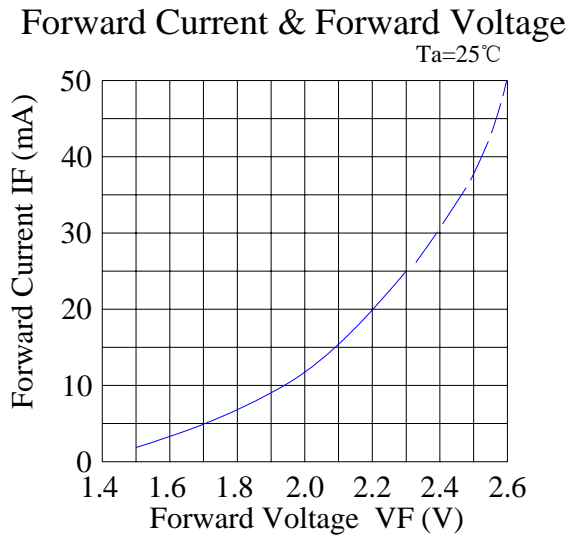
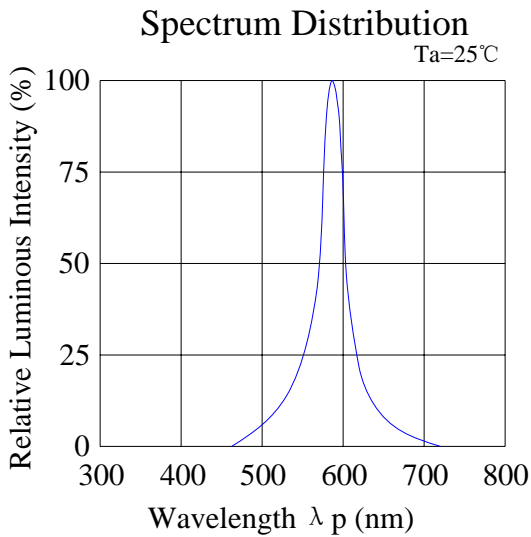

## Reliability Test Items And Conditions:

The reliability of products shall be satisfied with items listed below:

Confidence level: 90%.

LTPD: 10%.

### 1) Test Items and Results:

| Test Item   | Standard Test Method     | Test Conditions   | Note                 | Number of Damaged |
|---|--------------------------|---|----------------------|-------------------|
| Resistance to Soldering Heat                      | JEITA ED-4701<br>300 302 | Tsld=260±5°C, 10sec 3mm from the base of the epoxy bulb | 1 time               | 0/100             |
| Solder ability                                    | JEITA ED-4701<br>300 303 | Tsld=235±5°C, 5sec(using flux)                          | 1time over 95%       | 0/100             |
| Thermal Shock                                     | JEITA ED-4701<br>300 307 | 0°C~100°C 15sec, 15sec                                  | 100 cycles           | 0/100             |
| Temperature Cycle                                 | JEITA ED-4701<br>100 105 | -40°C~25°C~100°C~25°C<br>30min,5min,30min,5min          | 100 cycles           | 0/100             |
| Moisture Resistance Cycle                         | JEITA ED-4701<br>200 203 | 25°C~65°C~-10°C 90%RH<br>24hrs/1cycle                   | 10 cycles            | 0/100             |
| High Temperature Storage                          | JEITA ED-4701<br>200 201 | Ta=100°C  | 1000hrs              | 0/100             |
| Terminal Strength (Pull test)                     | JEITA ED-4701<br>400 401 | Load 10N (1kgf)<br>10±1sec                              | No noticeable damage | 0/100             |
| Terminal Strength (bending test)                  | JEITA ED-4701<br>400 401 | Load 5N (0.5kgf)<br>0°~90°~0° bend 2 times              | No noticeable damage | 0/100             |
| Temperature Humidity Storage                      | JEITA ED-4701<br>100 103 | Ta=60°C, RH=90%   | 1000hrs              | 0/100             |
| Low Temperature Storage                           | JEITA ED-4701<br>200 202 | Ta=-40°C  | 1000hrs              | 0/100             |
| Steady State Operating Life                       |                          | Ta=25°C, IF=30mA  | 1000hrs              | 0/100             |
| Steady State Operating Life of High Humidity Heat |                          | Ta=60°C, RH=90%,<br>IF=30mA                             | 500hrs               | 0/100             |
| Choice of various viewing angles                  |                          | Ta=-30°C, IF=30mA                                       | 1000hrs              | 0/100             |

### 2) Criteria For Judging The Damage:

| Item               | Symbol | Test Conditions | Criteria for Judgment |            |
|--------------------|--------|-----------------|-----------------------|------------|
|                    |        |                 | Min                   | Max        |
| Forward Voltage    | VF     | IF=20mA         | ---                   | F.V.*)×1.1 |
| Reverse Current    | IR     | VR=5V           | ---                   | F.V.*)×2.0 |
| Luminous Intensity | IV     | IF=10mA         | F.V.*)×0.7            | ---        |

\*) F.V.: First Value.

Please read the following notes before using the product:

1. Over-current-proof

Customer must apply resistors for protection, otherwise slight voltage shift will cause big current change (Burn out will happen).

2. Storage

2.1 Do not open moisture proof bag before the products are ready to use.

2.2 Before opening the package, the LEDs should be kept at 30°C or less and 90%RH or less.

2.3 The LEDs should be used within a year.

2.4 After opening the package, the LEDs should be kept at 30°C or less and 70%RH or less.

2.5 The LEDs should be used within 168 hours (7 days) after opening the package.

3. Soldering Iron

Each terminal is to go to the tip of soldering iron temperature less than 260°C for 5 seconds within once in less than the soldering iron capacity 25W. Leave two seconds and more intervals, and do soldering of each terminal. Be careful because the damage of the product is often started at the time of the hand solder.

4. Repairing

Repair should not be done after the LEDs have been soldered. When repairing is unavoidable, a double-head soldering iron should be used (as below figure). It should be confirmed beforehand whether the characteristics of the LEDs will or will not be damaged by repairing.