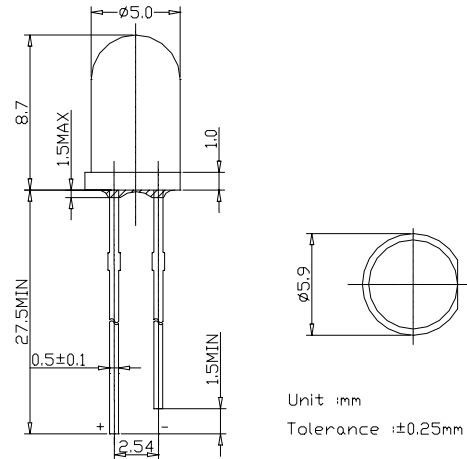

■Features

- High Power LEDs
- 5ø Standard Directivity
- Superior Weather-resistance
- UV Resistant Epoxy

■Applications

- Automotive Dashboard Lighting
- Back Lighting

■Outline Dimension

■Absolute Maximum Rating

(Ta=25)

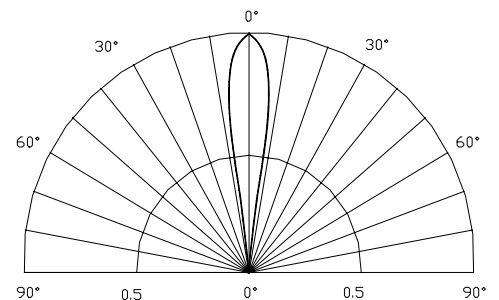
Item	Symbol	Value	Unit
DC Forward Current	I_F	30	mA
Pulse Forward Current*	I_{FP}	100	mA
Reverse Voltage	V_R	5	V
Power Dissipation	P_D	120	mW
Operating Temperature	T_{opr}	-30 ~ +80	
Storage Temperature	T_{stg}	-30 ~ +100	
Lead Soldering Temperature	T_{sol}	260 /3sec	-

■Directivity

*Pulse width Max.10ms Duty ratio max 1/10

■Electrical -Optical Characteristics

(Ta=25)

Item	Symbol	Condition	Min.	Typ.	Max.	Unit
DC Forward Voltage	V_F	$I_F=20mA$	2.8	3.4	4.0	V
DC Reverse Current	I_R	$V_R=5V$	-	-	30	μA
Domi. Wavelength	λ_D	$I_F=20mA$	465	470	475	nm
Luminous Intensity	I_v	$I_F=20mA$	7000	8400	10000	mcd
50% Power Angle	$2\theta_{1/2}$	$I_F=20mA$	-	15	-	deg

LED & Application Technologies