

ProLight PK2S-2LJE-A
2W Infrared 850 Power LED
Technical Datasheet
Version: 1.3

ProLight Opto ® PK2S Series

Features

- Instant light (less than 100ns)
- Lead free reflow soldering
- RoHS compliant
- Cool beam, safe to the touch
- Superior ESD protection

Main Applications

- Surveillance
- Gesture recognition
- In-cabin automotive device

Introduction

- ProLight Phenix 3535, is one of the smallest high power LED footprint available by ProLight Opto, has offered extended solid-state lighting design possibilities. ProLight Phenix 3535 is designed with ProLight own Patents and using copper leadframe, the best thermal material of the world.
- Phenix 3535 qualifies as the JEDEC Level 1 MSL sensitivity level and suitable for SMD process, Pb_free reflow soldering capability, and full compliance with EU Reduction of Hazardous Substances (RoHS) legislation.

Emitter Mechanical Dimensions

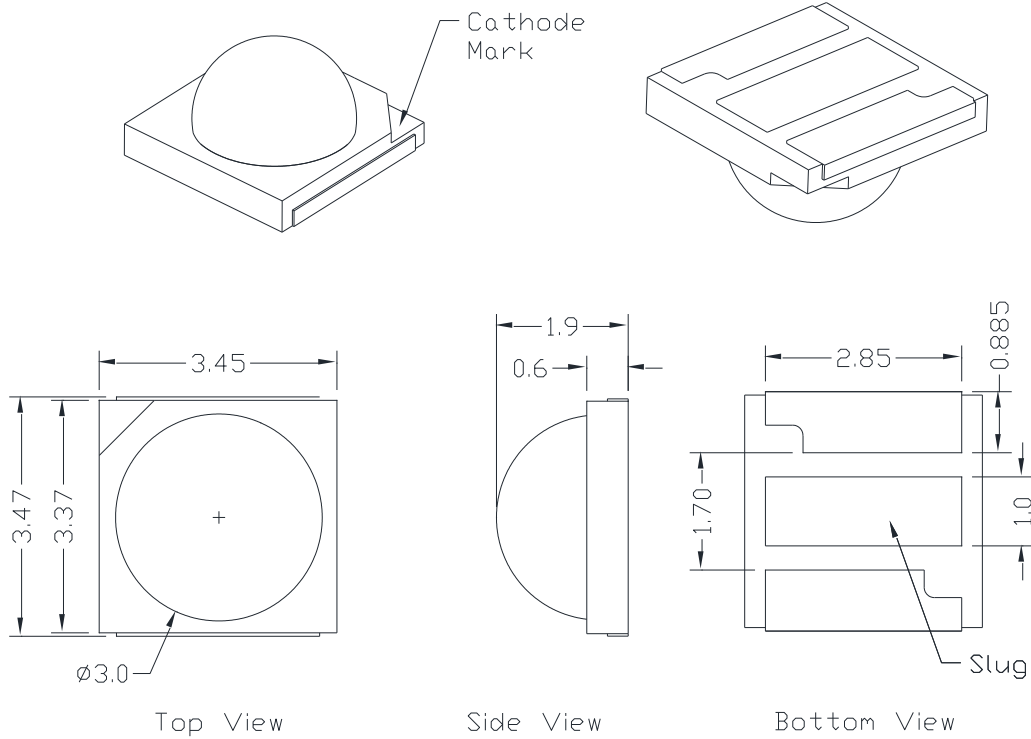

Circuit Diagram

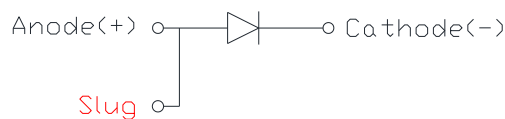

Notes:

1. The cathode side of the device is denoted by the chamfer on the part body.
2. Electrical insulation between the case and the board is required. Do not electrically connect either the anode or cathode to the slug.
3. Drawing not to scale.
4. All dimensions are in millimeters.
5. Unless otherwise indicated, tolerances are ± 0.10 mm.
6. Please do not solder the emitter by manual hand soldering, otherwise it will damage the emitter.
7. **Please do not use a force of over 0.3kgf impact or pressure on the lens of the LED, otherwise it will cause a catastrophic failure.**

*The appearance and specifications of the product may be modified for improvement without notice.

Flux Characteristics, $T_j = 25^\circ\text{C}$

| Part Number Emitter | Radiant Intensity I_e (mW/sr) | | Radiometric Power (mW) | | |
|------------------------|---------------------------------|------|------------------------|-----------------|-----------------|
| | @1000mA | | Refer @1000mA | Refer @350mA | Refer @700mA |
| | Min. | Typ. | Typ. | Typ. | Typ. |
| PK2S-2LJE-A | 200 | 290 | 950 | 350 | 680 |

- ProLight maintains a tolerance of $\pm 7\%$ on flux and power measurements.
- Please do not drive at rated current more than 1 second without proper heat sink.

Electrical Characteristics at 1000mA, $T_j = 25^\circ\text{C}$

| Color | Forward Voltage V_F (V) | | | Thermal Resistance Junction to Slug ($^\circ\text{C}/\text{W}$) |
|--------------|---------------------------|------|------|----------------------------------------------------------------------|
| | Min. | Typ. | Max. | |
| Infrared 850 | 1.50 | 1.75 | 2.30 | 8 |

- ProLight maintains a tolerance of $\pm 0.1\text{V}$ for Voltage measurements.

Optical Characteristics at 1000mA, $T_j = 25^\circ\text{C}$

| Radiation Pattern | Color | Peak Wavelength λ_P | | | Total included Angle (degrees) $\theta_{0.90V}$ | Viewing Angle (degrees) $2\theta_{1/2}$ |
|----------------------|--------------|-----------------------------|--------|--------|-------------------------------------------------------------|--------------------------------------------------|
| | | Min. | Typ. | Max. | | |
| Lambertian | Infrared 850 | 840 nm | 855 nm | 870 nm | 170 | 140 |

- ProLight maintains a tolerance of $\pm 1\text{nm}$ for dominant wavelength measurements.

Absolute Maximum Ratings

| Parameter | Infrared 850 |
|--------------------------------------------------------------|-------------------------------------------|
| DC Forward Current (mA) | 1000 |
| Peak Pulsed Forward Current (mA) | 1500 (less than 1/10 duty cycle@1KHz) |
| ESD Sensitivity (HBM per MIL-STD-883E Method 3015.7) | ±4000V (Class III) |
| LED Junction Temperature | 120°C |
| Operating Board Temperature at Maximum DC Forward Current | -40°C - 90°C |
| Storage Temperature | -40°C - 120°C |
| Soldering Temperature | JEDEC 020c 260°C |
| Allowable Reflow Cycles | 3 |
| Reverse Voltage | Not designed to be driven in reverse bias |

Radiometric Power Bin Structure at 1000mA

| Color | Bin Code | Minimum Radiant Intensity I _e (mW/sr) | Maximum Radiant Intensity I _e (mW/sr) | Available Color Bins |
|--------------|----------|--------------------------------------------------|--------------------------------------------------|----------------------|
| Infrared 850 | D | 200 | 250 | All |
| | E | 250 | 320 | 【1】 |
| | F | 320 | 400 | 【1】 |

- ProLight maintains a tolerance of ± 7% on flux and power measurements.
- The flux bin of the product may be modified for improvement without notice.
- **【1】 The rest of color bins are not 100% ready for order currently. Please ask for quote and order possibility.**

Peak Wavelength Bin Structure at 1000mA

| Color | Bin Code | Minimum Peak Wavelength (nm) | Maximum Peak Wavelength (nm) |
|--------------|----------|------------------------------|------------------------------|
| Infrared 850 | 1 | 840 | 870 |

- ProLight maintains a tolerance of ± 1nm for peak wavelength measurements.

Color Spectrum, $T_J = 25^\circ\text{C}$

1. Infrared 850

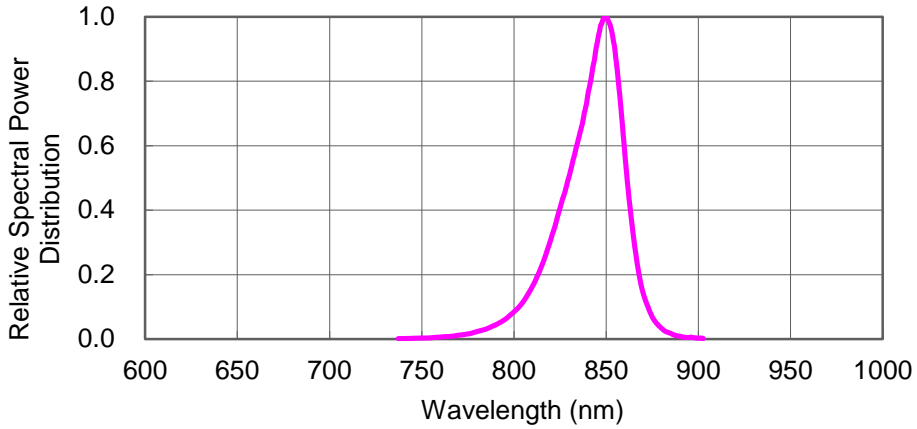

Light Output Characteristics

Relative Light Output vs. Junction Temperature at 1000mA

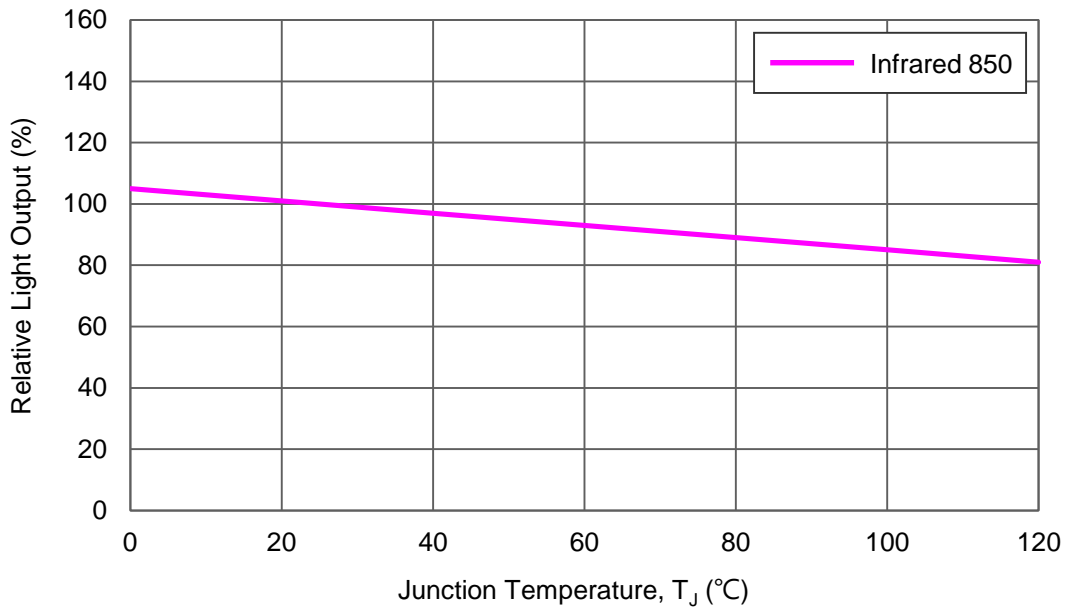

Forward Current Characteristics, $T_j = 25^\circ\text{C}$

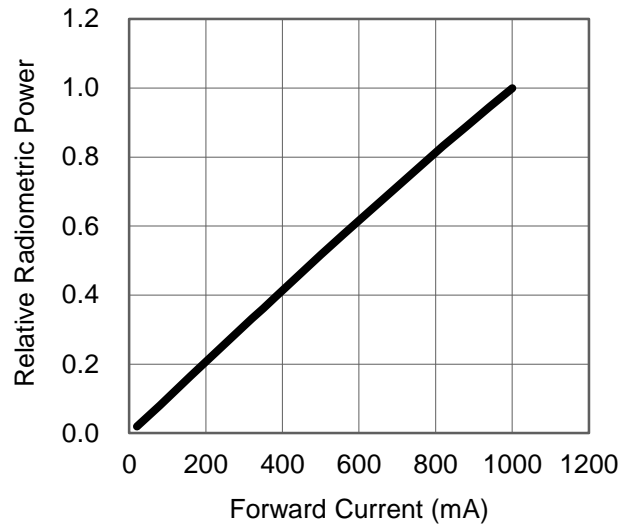
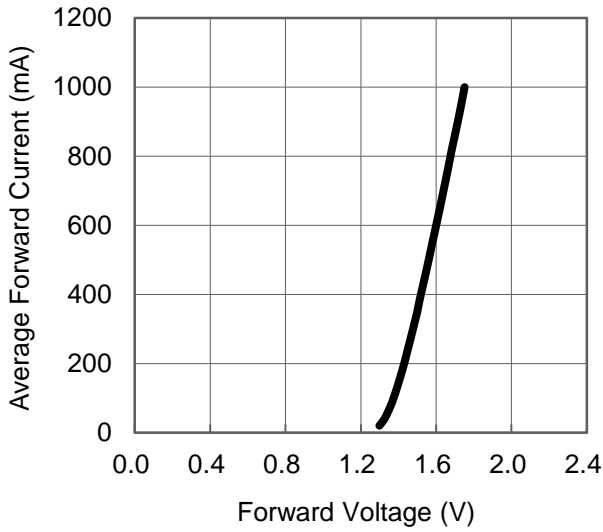

Ambient Temperature vs. Maximum Forward Current

1. Infrared 850 ($T_{JMAX} = 120^\circ\text{C}$)

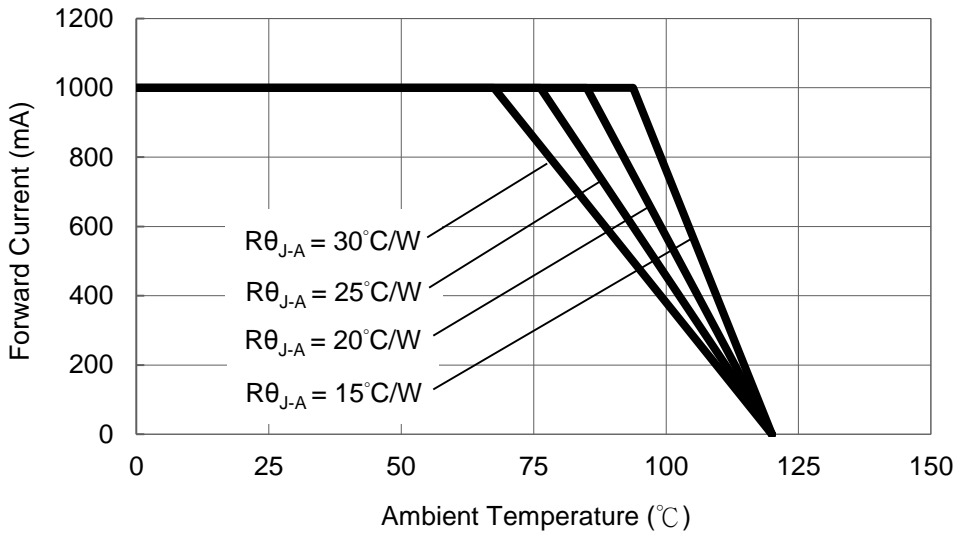

Typical Representative Spatial Radiation Pattern

Lambertian Radiation Pattern

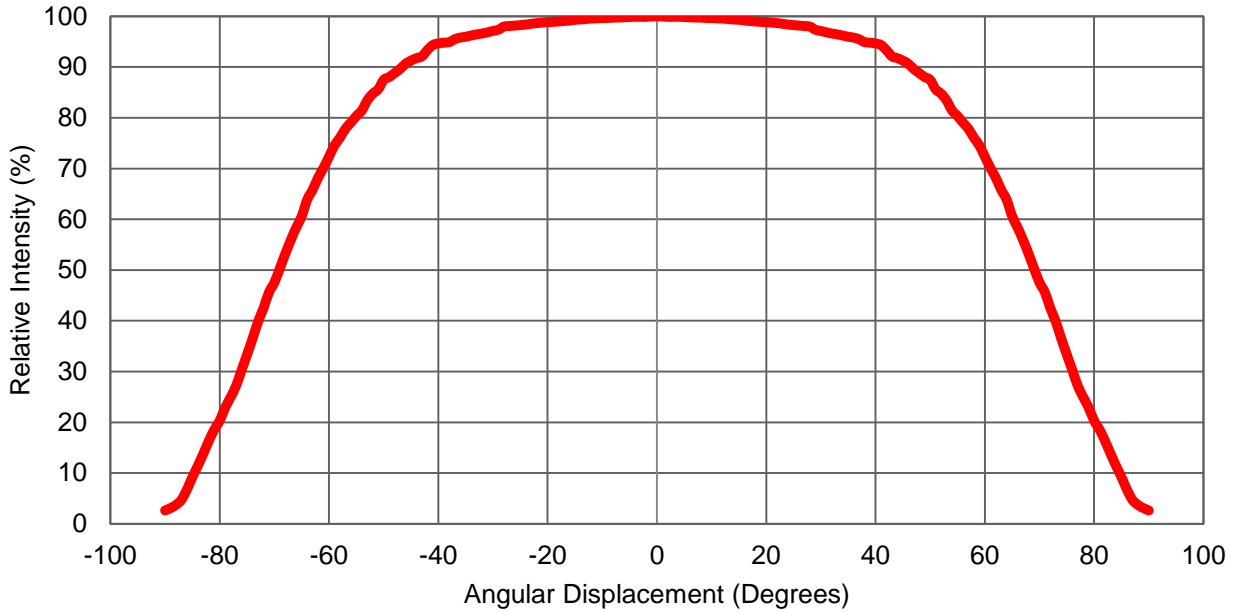

Qualification Reliability Testing

| Stress Test | Stress Conditions | Stress Duration | Failure Criteria |
|---------------------------------------------|-----------------------------------------------------------------------------|-----------------|-------------------------|
| Room Temperature Operating Life (RTOL) | 25°C, $I_F = \text{max DC}$ (Note 1) | 1000 hours | Note 2 |
| Wet High Temperature Operating Life (WHTOL) | 85°C/60%RH, $I_F = \text{max DC}$ (Note 1) | 1000 hours | Note 2 |
| Wet High Temperature Storage Life (WHTSL) | 85°C/85%RH, non-operating | 1000 hours | Note 2 |
| High Temperature Storage Life (HTSL) | 110°C, non-operating | 1000 hours | Note 2 |
| Low Temperature Storage Life (LTSL) | -40°C, non-operating | 1000 hours | Note 2 |
| Non-operating Temperature Cycle (TMCL) | -40°C to 120°C, 30 min. dwell, <5 min. transfer | 200 cycles | Note 2 |
| Mechanical Shock | 1500 G, 0.5 msec. pulse, 5 shocks each 6 axis | | Note 3 |
| Natural Drop | On concrete from 1.2 m, 3X | | Note 3 |
| Variable Vibration Frequency | 10-2000-10 Hz, log or linear sweep rate, 20 G about 1 min., 1.5 mm, 3X/axis | | Note 3 |
| Solder Heat Resistance (SHR) | 260°C ± 5°C, 10 sec. | | Note 3 |
| Solderability | Steam age for 16 hrs., then solder dip at 260°C for 5 sec. | | Solder coverage on lead |

Notes:

1. Depending on the maximum derating curve.
2. Criteria for judging failure

| Item | Test Condition | Criteria for Judgement | |
|-------------------------------------------------|-----------------------|------------------------|---------------------|
| | | Min. | Max. |
| Forward Voltage (V_F) | $I_F = \text{max DC}$ | -- | Initial Level x 1.1 |
| Luminous Flux or Radiometric Power (Φ_V) | $I_F = \text{max DC}$ | Initial Level x 0.7 | -- |

* The test is performed after the LED is cooled down to the room temperature.

3. A failure is an LED that is open or shorted.

Recommended Solder Pad Design

Standard Emitter

TYPE A.

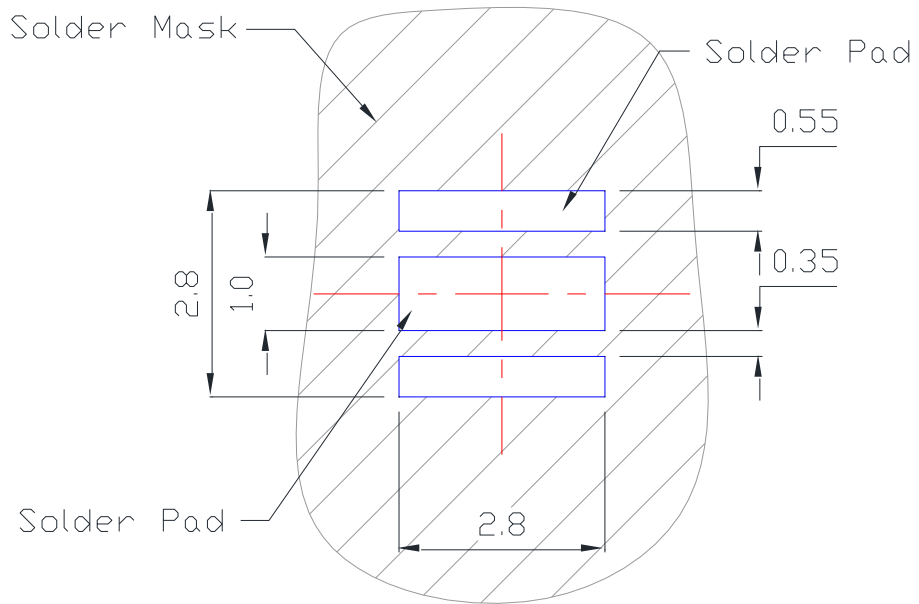

TYPE B.

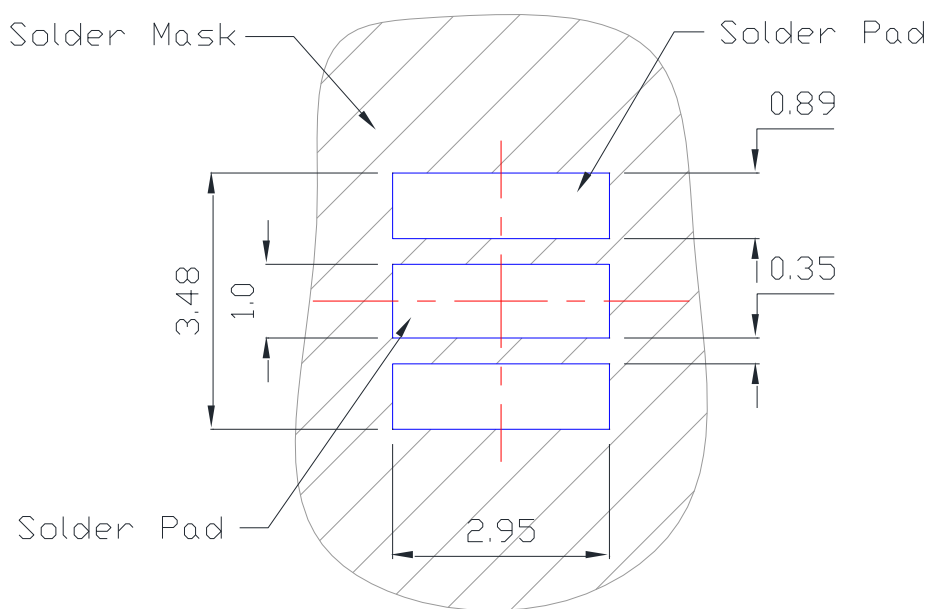

- All dimensions are in millimeters.
- Electrical isolation is required between Slug and Solder Pad.

Reflow Soldering Condition

| Profile Feature | Sn-Pb Eutectic Assembly | Pb-Free Assembly |
|-------------------------------------------------------------------------------------------------------------------------------------------------------------------------------------------------------------------------|----------------------------------|----------------------------------|
| Average Ramp-Up Rate (T_{Smax} to T_p) | 3°C / second max. | 3°C / second max. |
| Preheat <ul style="list-style-type: none"> – Temperature Min (T_{Smin}) – Temperature Max (T_{Smax}) – Time (t_{Smin} to t_{Smax}) | 100°C 150°C 60-120 seconds | 150°C 200°C 60-180 seconds |
| Time maintained above: <ul style="list-style-type: none"> – Temperature (T_L) – Time (t_L) | 183°C 60-150 seconds | 217°C 60-150 seconds |
| Peak/Classification Temperature (T_p) | 240°C | 260°C |
| Time Within 5°C of Actual Peak Temperature (t_p) | 10-30 seconds | 20-40 seconds |
| Ramp-Down Rate | 6°C/second max. | 6°C/second max. |
| Time 25°C to Peak Temperature | 6 minutes max. | 8 minutes max. |

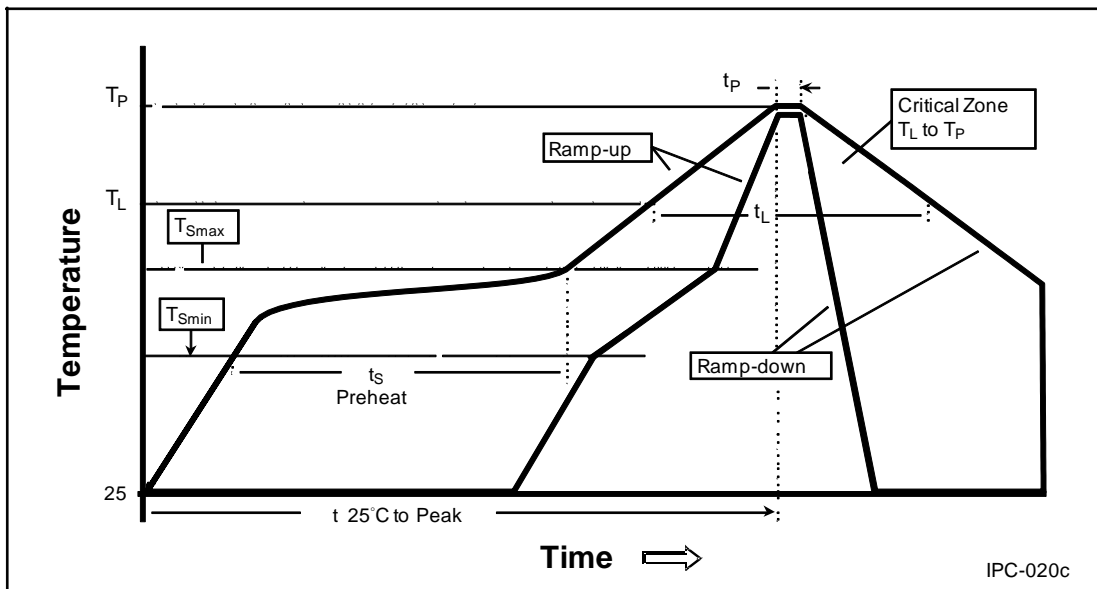

- We recommend using the M705-S101-S4 solder paste from SMIC (Senju Metal Industry Co., Ltd.) for lead-free soldering.
- Do not use solder pastes with post reflow flux residue > 47%. (58Bi-42Sn eutectic alloy, etc) This kind of solder pastes may cause a reliability problem to LED.
- All temperatures refer to topside of the package, measured on the package body surface.
- Repairing should not be done after the LEDs have been soldered. When repairing is unavoidable, a double-head soldering iron should be used. It should be confirmed beforehand whether the characteristics of the LEDs will or will not be damaged by repairing.
- Reflow soldering should not be done more than three times.
- When soldering, do not put stress on the LEDs during heating.
- After soldering, do not warp the circuit board.

Emitter Reel Packaging

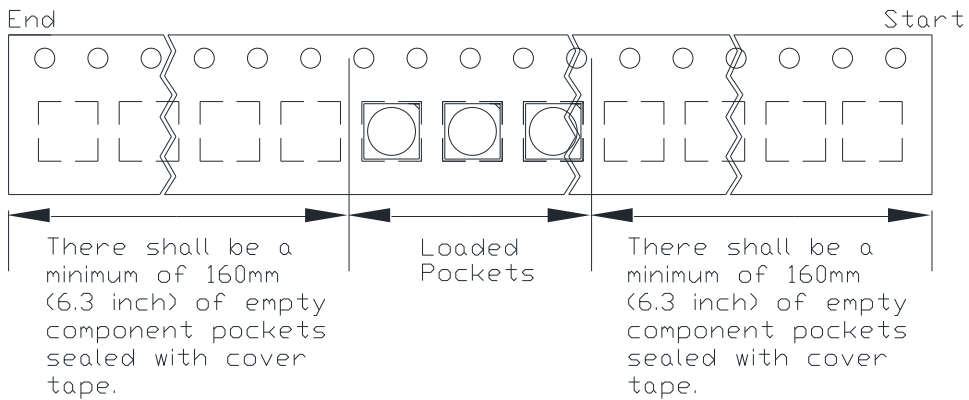
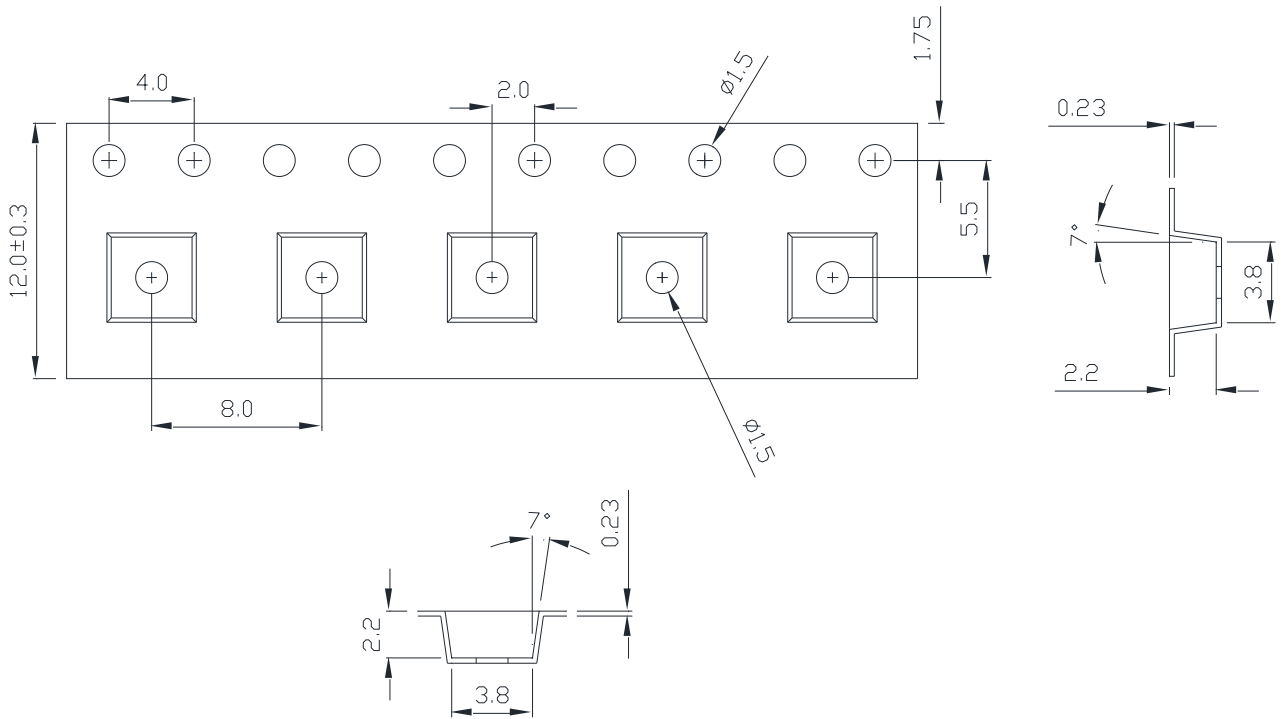

Notes:

1. Drawing not to scale.
2. All dimensions are in millimeters.
3. Unless otherwise indicated, tolerances are ± 0.10 mm.

Emitter Reel Packaging

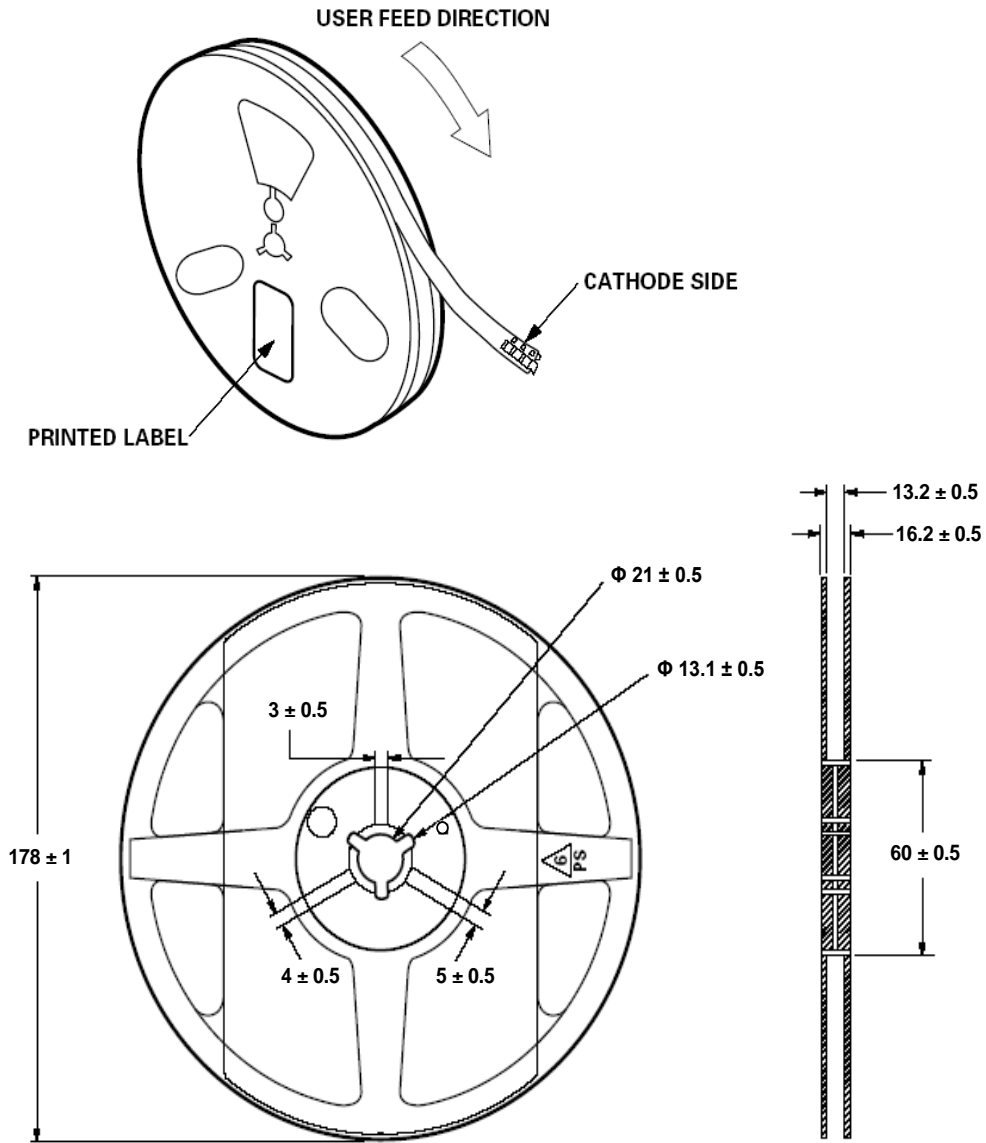

Notes:

1. Empty component pockets sealed with top cover tape.
2. 250, 500 and 1000 pieces per reel.
3. Drawing not to scale.
4. All dimensions are in millimeters.

Precaution for Use

- Storage
Please do not open the moisture barrier bag (MBB) more than one week. This may cause the leads of LED discoloration. We recommend storing ProLight's LEDs in a dry box after opening the MBB. The recommended storage conditions are temperature 5 to 30 °C and humidity less than 40% RH. It is also recommended to return the LEDs to the MBB and to reseal the MBB.
- The slug is is not electrically neutral. Therefore, we recommend to isolate the heat sink.
- **We recommend using the M705-S101-S4 solder paste from SMIC (Senju Metal Industry Co., Ltd.) for lead-free soldering.**
- **Do not use solder pastes with post reflow flux residue>47%. (58Bi-42Sn eutectic alloy, etc) This kind of solder pastes may cause a reliability problem to LED.**
- Any mechanical force or any excess vibration shall not be accepted to apply during cooling process to normal temperature after soldering.
- Please avoid rapid cooling after soldering.
- Components should not be mounted on warped direction of PCB.
- Repairing should not be done after the LEDs have been soldered. When repairing is unavoidable, a heat plate should be used. It should be confirmed beforehand whether the characteristics of the LEDs will or will not be damaged by repairing.
- This device should not be used in any type of fluid such as water, oil, organic solvent and etc. When cleaning is required, isopropyl alcohol should be used.
- When the LEDs are illuminating, operating current should be decide after considering the package maximum temperature.
- The appearance, specifications and flux bin of the product may be modified for improvement without notice. Please refer to the below website for the latest datasheets.
<http://www.prolightopto.com/>

Handling of Silicone Lens LEDs

Notes for handling of silicone lens LEDs

- Please do not use a force of over 0.3kgf impact or pressure on the silicone lens, otherwise it will cause a catastrophic failure.
- The LEDs should only be picked up by making contact with the sides of the LED body.
- Avoid touching the silicone lens especially by sharp tools such as Tweezers.
- Avoid leaving fingerprints on the silicone lens.
- Please store the LEDs away from dusty areas or seal the product against dust.
- When populating boards in SMT production, there are basically no restrictions regarding the form of the pick and place nozzle, except that mechanical pressure on the silicone lens must be prevented.
- Please do not mold over the silicone lens with another resin. (epoxy, urethane, etc)

